

# TAZOLI GMBH

BATTERIEN & WERKZEUGE



Aktuelle Preise



## WERKZEUGKATALOG 2024













Unverbindlich empfohlene Listenpreise zzgl. MwSt.  
Preisgültigkeit ab 1.1.2024 bis spätestens 31.12.2024  
Preisänderungen vor 31.12.2024 vorbehalten. Irrtümer vorbehalten

EINFACH VIGOR.





EINFACH VIGOR.

	<b>Werkstattwagen und Betriebseinrichtung</b>	→ 26–89
	<b>Werkzeugaufbewahrung</b>	→ 90–119
	<b>Handwerkzeuge</b>	→ 120–227
	<b>Drehmoment-Werkzeuge</b>	→ 228–229
	<b>Pneumatik-Werkzeuge</b>	→ 230–237
	<b>Allgemeiner Werkstattbedarf</b>	→ 238–250
	<b>Diagnose / Batterie / Elektrik</b>	→ 251–257
	<b>Motor / Kühlung / Klima</b>	→ 258–270
	<b>Öldienst</b>	→ 271–276
	<b>Bremsen</b>	→ 277–294
	<b>Räder / Reifen</b>	→ 295–306
	<b>Karosserie</b>	→ 307–314
	<b>Kfz / Nfz Fahrwerk Spezial-Werkzeug</b>	→ 320–415

Werkstattwagen mit Sortiment	29–45	Servicewagen	57		
Mobile Werkbank mit Sortiment	46–47	Zubehör für Werkstattwagen	58–65		
Werkstattwagen ohne Sortiment	48–53, 56	Schrankwand-System	67–78		
Mobile Werkbank ohne Sortiment	54–55	Zubehör Schrankwand-System	79–89		
<hr/>					
Multiboxen	92–93				
Weichschaum-Einlagen	94–119				
<hr/>					
Steckschlüssel Systeme	122–175	VDE Werkzeuge	209–212		
Universal Werkzeugkoffer	176–177	Schlag-, Schaber- und Lösewerkzeuge	213–220		
Schraubenschlüssel	178–185	Diverse Handwerkzeuge	220–221		
Schraubendreher und Bits	186–198	Schneiden und Sägen	221–227		
Zangen	199–208				
<hr/>					
Drehmomentschlüssel	229				
Drehwinkel-Messgerät	229				
<hr/>					
Schlagschrauber	231–232				
Luftfräsen	233				
Stabschleifer	234				
Pneumatik-Pistolen	235, 237				
Schlauchaufroller	236				
<hr/>					
Video-Endoskop	252				
Rauchgas-Leckagetester	253				
Elektrik	254				
	256–257				
Multimeter	254				
Kabelentriegelung	255				
Crimpzangen Satz	256				
<hr/>					
Motor-Werkzeuge	259–262				
Kühlsystem-Diagnose	263–265				
Turbosystem-Diagnose	266–267				
Kompressions- und Druckverlusttester	268				
Vakuum- und Druckpumpen Satz	269				
Injektorschacht Reinigung	270				
<hr/>					
Öl-Messstäbe	272				
Ölfilter-Spannschlüssel	273–274				
Öl-Pumpen und Einfüllgeräte	275–276				
<hr/>					
Bremsenwartung und Entlüftung	278–280				
Bremskolben-Rückstellwerkzeuge	281–284				
Brems Scheiben-Werkzeuge	285–286				
Bördelgeräte	287–289				
Inspektions-Werkzeuge	290–294				
<hr/>					
Schlagschrauber-Krafteinsätze	296–298				
Wagenheber und Böcke	299–302				
Räder / Reifen-Werkzeuge	303–306				
<hr/>					
Scheibenwischerarm-Abzieher Satz	308				
Reparatur und Einbausätze	309				
Induktionsheizgerät und Zubehör	310–314				
<hr/>					
Kfz-Fahrwerk Diverse	315–319	Werkzeugsätze Standard-Radlager	331–334	Werkzeugsätze Lager und Buchsen	366–375
Druck- und Zugzylinder	322–324	Werkzeugsätze Kompakt-Radlager	335	Federspanner	376–379
Hydraulik-Pumpen	325	Werkzeugsätze geschraubte Kompakt-Radlager	336–345	Mobile Werkbänke mit Spezialwerkzeug Sortiment	380–388
Zubehör Zylinder	326–329	Werkzeugsätze Radnabe mit 6- und 8- Bolzen	344	Spezial Weichschaum-Einlagen	389–395
Mechanischer Antrieb	330	Werkzeugsätze Antriebswellen	345	Werkzeugsätze Nfz	396–415
		Multiboxen	346–363		



## Erklärung Antriebssymbole

	Für Schlitz-Schrauben
	Für Kreuzschlitz-Schrauben (PH)
	Für Pozidriv-Schrauben (PZ)
	Für Innensechskant-Schrauben
	Für Außensechskant-Schrauben
	Für Innen Sechsrund Schrauben
	Für Tamper Resistant Sechsrund Schrauben (Innen Sechsrund Schrauben mit Zapfenführung)
	Für Außen Sechsrund Schrauben
	Für Innenvielzahn-Schrauben (XZN)
	Für Innenkeilprofil-Schrauben
	Für Polydrive-Schrauben
	Für Innen-5-Stern-Schrauben mit Zapfen
	Für Tri-Wing® Schrauben
	Nenngröße 6,3 mm
	Nenngröße 10 mm
	Nenngröße 12,5 mm
	Nenngröße 20 mm
	Nenngröße 25 mm
	Innen-Vierkant
	Außen-Vierkant
	Innen-Sechskant
	Außen-Sechskant
	EN/IEC 60900:2004

## Erklärung der Piktogramme

	Kfz Werkzeug
	LKW Werkzeug
	Betriebsanleitung / Anwendungshinweis
	Zentralverriegelung
	Gewicht Werkstattwagen
	Traglast Werkstattwagen
	Teiligkeit
	Zähne
	Drehwinkel
	Bohrungen
	Wellen
	Magnet
	Leuchtdauer
	Ladezeit
	Gewicht
	Batterietyp
	Akkustisches Signal
	Betriebsdruck
	Vibration
	U/min
	Lautstärke
	Max. Lösemoment
	Doppelhammerschlagwerk
	Kupplungsstecker-Nennweite
	Batterietyp
	Prüfgeräte
	SUV/Van
	Landmaschinen
	Industrie
	QR-Code
	Anwendungsvideo
	Schlauchlänge
	Ölinhalt
	Hydraulische Nutzung
	Mechanische Nutzung

## A

Abisolierzange .....	212
Abzieher / Auszieher .....	261, 308, 317, 319, 339–340, 342, 344, 345, 366–367, 372, 402, 407, 409–410, 412
Achsen Werkzeug .....	317
Adapter / Verbindungsstück .....	131, 142–143, 164, 167, 170, 267, 279, 326–327, 365, 379
Antriebswelle Werkzeug .....	332, 344, 345, 350, 364–365, 391, 393, 398, 404–410
Arbeitsplatte .....	63, 82–83
Aufsatzkoffer .....	49
Ausblaspistole .....	235–236
Austreiber .....	214, 217
Auswuchtgewichtzange .....	303
Autolichtprüfer .....	254, 256

## B

Bandmaß .....	220
Biegsamer Schraubendreher .....	190
Bits und Schraubendreher .....	99, 104, 107–109, 117, 125, 128–129, 131, 137–141, 143, 145–148, 158–164, 186–193, 196–198, 210–211
Bockrolle .....	62
Bohrer .....	225
Bördelgerät .....	287–290, 292
Brecheisen .....	218–220, 303
Bremsen Werkzeug .....	278–282, 284–294, 395, 410, 412
Bürste .....	215, 217, 225–227, 247

## C

Crimpzange .....	256
Cuttermesser .....	222–223

## D

Diagnose .....	211, 220–221, 229, 254, 256, 261, 263–264, 266–269, 272, 286, 291, 303
Doppel-Maulschlüssel .....	97, 178
Doppel-Ratschen-Ringschlüssel .....	184–185
Doppel-Ringschlüssel .....	98, 180, 182, 184
Doppelgelenkzange .....	99, 199–200
Dosenhalter .....	60
Drahtbürste .....	225
Drehgriffknarre .....	125–126, 135, 155
Drehmoment Werkzeug .....	229
Drehwinkel-Messgerät .....	229
Druck-Hydraulikzylinder .....	322–324, 326, 328, 350, 390, 393
Druckluft Werkzeug .....	96, 102–103, 118, 231–237, 297–298
Druckspindel .....	328, 330
Druckverlust- / Kompression-Tester .....	268–269
Durchtreiber .....	100, 214, 217

## E

Eckunterschrank .....	76
Einlegeboden .....	64
Elektriker Werkzeug .....	101, 104, 209–212

## F

Fahrgriff .....	60, 64
Fahrwerk Werkzeug .....	288, 291, 296–297, 303–306, 315, 317–319, 331–344, 345, 347–348, 350–353, 360, 363–365, 368, 370–375, 379, 390–391, 393, 395–398, 400–402, 404–410, 412–413
Fäustel .....	213
Federbolzen Werkzeug .....	411, 414–415
Federspanner .....	377–379
Feile .....	101, 224, 290
Feinzahnknarre .....	124–125, 135, 154
Fingerratsche .....	125
Flachmeißel .....	214, 217
Flachrundzange .....	199, 207, 212
Flachschlüssel .....	108
Flaschenwagenheber .....	301
Flexible / schwenkbare Verlängerung .....	130, 142, 164
Flexibler Schraubendreher .....	190
Flügeltürschrank .....	75, 77
Fühlerlehre .....	220
Führungsschiene .....	63

## G

Gabel-Ringschlüssel .....	97, 108–109, 117
Gabelschlüssel .....	97–98, 108–109, 117, 183, 185
GaslötKolben .....	242
Gelenk Ratschen-Ring-Maulschlüssel .....	98, 183
Gelenkgriff .....	154
Gelenkwelle-Abzieher .....	317, 339
Gleitgriff / Gleitstück .....	126, 155, 167
Gripzange .....	100, 202–203
Gummihammer .....	304

## H

Hammer .....	100, 104, 117–118, 213, 304, 365
Hängeschrank .....	78
Hebeleisen .....	218–220, 303
Holz-Arbeitsplatte .....	63
HSS Bohrer .....	225
Hydraulikpumpe und Zubehör .....	325
Hydraulikwagenheber .....	299–300
Hydraulikzylinder .....	322–324, 326, 328, 350, 390, 393

## I

Induktionsheizgerät und Zubehör .....	311–314
Injektorschacht Reinigung .....	270
Innenkeil (Ribe CV) Werkzeug .....	104, 147–148, 161
Innensechskantprofil Werkzeug .....	97, 129, 134, 140–141, 147, 152, 158, 162–163, 210
Inspektions Werkzeug .....	290, 293

## J

Japanspachtel .....	240
---------------------	-----

## K

Kabelentriegelung.....	255
Karosserie Werkzeug.....	308–309, 311–314
Keilrippenriemen Werkzeug.....	262
Kfz Werkzeug.....	254–256, 315, 318–319, 331–344, 345, 347–348, 351–353, 379, 390, 393, 395–398, 400–401, 406, 408, 412
Kfz-Elektrik / -Elektronik.....	254–256
Kfz-Fahrwerk / Spurstange / Stoßdämpfer.....	315, 340, 342–344, 345, 379
Klappmesser.....	222–223
Klebegewicht Werkzeug.....	303, 305
Klemmschrauben Werkzeug.....	315
Knarre / Knarrenschlüssel.....	98, 124–126, 135, 154–155, 167, 171, 180–181, 183–184, 209
Knarren-Ring-Maulschlüssel.....	98, 180–181, 183
Knarrenkasten.....	122–124, 132–133, 144, 149, 167, 169–175, 209, 297–298
Kniebrett.....	246
Koffer.....	92–93, 171, 176–177, 347–348, 350–353, 360, 363, 395, 400–401
Kombizange.....	199, 207, 212
Kompakt-Radlager Werkzeug.....	338–345, 348–349, 351–353, 393–395
Kompressions- und Druckverlust-Tester.....	268–269
Körner.....	214, 216
Kraftschrauber und -Einsätze.....	96, 102–103, 118, 151, 165–166, 168–169, 231–232, 296–298
Krallengreifer.....	241
Kreuzmeißel.....	214, 216
Kreuzschlitz (PH) Werkzeug.....	129, 138, 186, 188, 210
Kugelgelenk Abzieher.....	366–367, 372, 402
Kühlsystem-Diagnose.....	263–264
Kunststoffhaube.....	63
Kunststoffreparatur Werkzeug.....	309

## L

Lager- und Buchsen Werkzeug.....	337–338, 356–360, 363, 366–368, 370–375, 396–399, 402, 412–413
Lagerinnenring Abziehwerkzeug.....	319
Lambdasonde Werkzeug.....	259
Laufbühne / Leiter.....	249
Lenkradeinstellwaage.....	304
Lenkrolle.....	62
Lochwandplatte.....	84, 88
Lösehebel.....	218–220, 303
LötKolben.....	242
Luftratsche / -schrauber.....	233, 297–298

## M

Magnetheber.....	241
Manometer.....	329
Maulschlüssel.....	97–98, 108–109, 117, 180–181, 183
Mechanische Spindel.....	328, 330
Mehrzweckwanne.....	242
Meißel.....	100, 104, 117–118, 214
Messen / Prüfen.....	211, 220–221, 229, 254–256, 261, 263–264, 266–269, 272, 286, 290–291, 293, 303
Messer / Schere.....	221–223, 225
Mobile Werkbank.....	46–47, 54–55
Montagehebel.....	303
Montagewagen.....	29–31, 33–40, 42–44, 48–53, 55–60, 62–65
Motor Werkzeug.....	259, 261–263, 266–268, 270
Multiboxen.....	92–93, 347–353, 356–360, 363, 394–395, 399–401
Multimeter / Messkabel.....	254
Multiprofil Werkzeug.....	124, 128, 149, 157
Multitool.....	239

## N

Nfz Werkzeug.....	402, 404–415
Nietzange.....	205–206
Nuss / Stecknuss.....	95–96, 101, 103, 105–107, 116, 122–151, 154–175, 192, 209–210, 260, 296–298
Nusskasten.....	122–124, 132–133, 144, 149, 167, 169–170, 172–175

## Ö

Öldienst Werkzeug.....	242, 272–276
------------------------	--------------

## P

Papierrollenhalter.....	59
Phasenprüfer.....	211
Pinzette.....	241
Pneumatik Werkzeug.....	96, 102–103, 118, 231–237, 297–298
Pozidriv (PZ) Werkzeug.....	129, 138
Prüfen / Messen.....	229, 254, 268–269, 290, 293

## R

Räder- / Reifen Werkzeug.....	296–297, 303–306
Radlager Werkzeug Kfz.....	318–319, 331–344, 345, 347–348, 351–353, 390–391, 393, 395–398, 400–401, 406, 408, 412
Rangierwagenheber.....	299–302
Ratsche / Ratschenschlüssel.....	98, 124–126, 135, 154–155, 167, 171, 180–181, 183–185, 209
Ratschen-Ring-Maulschlüssel.....	98, 111, 180–181, 183
Ratschenkasten.....	122–124, 132–133, 144, 149, 167, 169–175, 209, 297–298
Refraktometer.....	263
Regalboden.....	84
Reifenheber.....	303
Ribe CV Werkzeug.....	104, 147–148, 161
Ring-Maulschlüssel.....	97, 108–109, 112, 117, 179
Ringschlüssel.....	98, 180–184
Rohrschneider.....	225
Rollbrett.....	93
Rundfeile.....	224
Rundzange.....	212

## S

Säge.....	221–222
Satz / Sortiment.....	95–109, 116–119, 122–124, 133, 144–147, 149, 167–170, 172–175, 183, 187–189, 191–193, 201, 203, 209, 211, 215, 217–220, 225, 240–242, 247, 256, 259, 261–262, 264, 266–267, 269–270, 272, 276, 278, 280, 288–289, 294, 297–298, 301–303, 308–309, 315, 326, 328, 330, 332, 3 34–336, 341, 344, 352–353, 360, 363, 365, 371–373, 390–393, 395, 404–405, 407–408, 411–415
Saugheber.....	250
Schaber.....	100–101, 215, 217
Schaummatte.....	64
Scheibenwischerarm-Abzieher.....	308
Schere / Messer.....	221–223, 225
Schiebestück.....	143
Schieblehre.....	221
Schlagschrauber und -Einsätze.....	96, 102–103, 118, 151, 165–166, 168–169, 231–232, 296–298



## S

Schlauchschellen-Zange.....	204, 262
Schleifen / Trennen / Zerspanen.....	101, 221–225, 234, 248–249, 290
Schlitzprofil Werkzeug.....	129, 137, 186, 210–211
Schloss.....	63
Schlosserhammer.....	213
Schmierer / Reinigen / Pflegen.....	237
Schonhammer.....	213, 304
Schrankwand-System.....	65, 67–80, 82–89
Schraubenausdreher.....	150, 165
Schraubendreher und Bits.....	96–97, 99, 101, 104, 107–109, 112, 117, 125, 128–129, 131, 137–141, 143, 145–148, 158–164, 186–193, 196–198, 210–211
Schraubendreher-Einsatz.....	96–97, 107–108, 111, 128–129, 134, 137–141, 145–148, 152–153, 158–163, 210
Schraubenschlüssel.....	97–98, 108–109, 180–184
Schraubstock.....	65
Schubblade.....	62
Schubblade-Trennblech.....	61
Schubladenunterschrank.....	70–74
Schwenkbare / flexible Verlängerung.....	130, 142, 164
Sechsrund Werkzeug.....	96, 99, 104, 127–128, 134, 137–139, 146, 153, 157, 159–162, 171, 189, 191, 193
Seegeringzange.....	102, 200–202, 204, 262, 331
Seitenschneider.....	199, 207–208, 212
Servicewagen.....	57
Sicherheits-Laufbühne.....	249
Sicherungsringzange.....	102, 200–202, 204, 262, 331
Silentlager- / Buchsen Werkzeug.....	360, 363, 368, 370–371, 373–375, 413
Sortiment / Satz.....	95–109, 116–118, 122–124, 133, 144, 149, 167–175, 183, 187–189, 191–193, 201, 203, 209, 211, 215, 217–220, 225, 240–242, 247, 256, 259, 261–262, 264, 266–267, 270, 272, 276, 278, 280, 288–289, 294, 297–298, 301–303, 308–309, 315, 326, 328, 330, 332, 334–336, 341, 347, 350–353, 360, 363, 365, 371–373, 390–393, 400–401, 404–405, 407–408, 411, 413–415
Spachtel.....	240
Spindel, mechanisch.....	328, 330
Spiralbohrer.....	225
Spiralnutenausdreher-Einsatz.....	150, 165
Splinttreiber.....	100, 214, 217
Sprengringzange.....	102, 200–202, 204, 262, 331
Stabschleifer.....	234
Steckgriff.....	126
Steckschlüssel System Kombination.....	110, 122, 170–175
Steckschlüsseleinsatz.....	95–96, 101–103, 105–107, 116, 118, 122–151, 154–175, 192, 209–210, 260, 285, 296–297
Stoßdämpfer Werkzeug.....	315–316, 340, 342–344, 345, 379

## T

T-Griff Schraubendreher.....	109, 193
Tamper-Resistant Sechsrund Werkzeug.....	128, 138–139
Teleskopspiegel.....	240
Teppichmesser.....	222–223
Tiefenmesser.....	303
Traggelenk Werkzeug.....	315, 371–372, 402
Turbosystem-Diagnose.....	261, 266–267

## U

Umschaltknarre.....	124–126, 135, 154–155, 167, 209
Universalgelenk.....	131, 142, 163, 169
Universalzange.....	208
Unterstellbock und Wagenheber.....	299–302

## V

Vakuum- und Druckpumpe.....	269, 275
VDE Werkzeug.....	101–102, 104, 209–212
Verbindungsstück / Adapter.....	119, 131, 142–143, 164, 167, 170, 267, 279, 326–327, 329, 365, 379
Verlängerung.....	130, 142, 164, 168, 210
Vielzahn Werkzeug.....	97, 104, 146, 158–159
Vierkant Antrieb	
6,3 mm (1/4 Zoll).....	95, 105–106, 116, 122–131, 143, 173–175
10 mm (3/8 Zoll).....	128, 131–143, 157, 164, 176–177, 260
12,5 mm (1/2 Zoll).....	95, 105–106, 116, 130, 143–151, 154–168, 173–175, 209–210, 233, 296–298
20 mm (3/4 Zoll).....	167–169
VIGOR 1000.....	33–35, 46–47, 54
VIGOR 1000 XD.....	42–43, 53
VIGOR 1000 XL.....	38–40, 44, 51–52, 55–56
Vollstahlknarre.....	124–125, 135, 154
VSS – VIGOR Schrankwand System.....	65, 67–80, 82–89

## W

Wagenheber und Unterstell-Böcke.....	299–302
Wanne.....	242
Weichschaum-Einlage.....	95–109, 113–119, 351, 390–393
Werkbank und Zubehör.....	46–47, 54–55
Werkstatt-Einrichtung.....	65, 67–69, 72, 75, 77–80, 82–89, 242–246, 250, 252, 318
Werkstattwagen und Zubehör.....	29–31, 33–40, 42–44, 48–53, 55–60, 62–65
Werkzeug für Kfz.....	254–256, 315, 318–319, 331–344, 345, 347–348, 351–353, 379, 390, 393, 395–398, 400–401, 406, 408, 412
Werkzeug für Nfz.....	402, 404–415
Werkzeug-Organisation.....	29–31, 33–40, 42–44, 46–60, 62–65, 67–69, 72, 75, 77–80, 82–89, 9 5–109, 116–119, 351, 390–393
Werkzeughaken.....	65
Werkzeugkoffer / -kasten.....	92–93, 171, 176–177, 347, 350–351, 360, 363, 395, 400–401
Winkelschraubendreher.....	109, 191

## X

XZN Werkzeug.....	97, 104, 134, 146, 152, 158–159
-------------------	---------------------------------

## Z

Zange.....	100, 102, 109, 117–118, 199–208, 211–212, 256, 262, 303, 331
Zubehör Hydraulikpumpe.....	325, 329
Zug-Hydraulikzylinder.....	322–324
Zündkerzen Werkzeug.....	137, 157, 199–200, 260

VIGOR-No.	Seite	VIGOR-No.	Seite	VIGOR-No.	Seite	VIGOR-No.	Seite	VIGOR-No.	Seite	VIGOR-No.	Seite
V1008	181	V1461N-14X15	178	V1803	203	V1988	157	V2082	158	V2140	128
V1009	181	V1461N-16X17	178	V1804	203	V1989	157	V2083	158	V2141	128
V1010	181	V1461N-18X19	178	V1808	203	V1990	157	V2084	158	V2142	128
V1021	181	V1461N-20X22	178	V1897	124	V1991	157	V2085	158	V2143	137
V1022	181	V1461N-21X23	178	V1898	149	V1992	157	V2086	158	V2144	137
V1023	181	V1461N-24X27	178	V1901	49	V1993	157	V2087	158	V2145	137
V1025	181	V1461N-25X28	178	V1901/376	32	V1994	157	V2088	158	V2146	137
V1026	181	V1461N-30X32	178	V1902	49	V1995	157	V2089	158	V2149	139
V1027	181	V1524N	180	V1903	63	V1996	157	V2090	158	V2151	159
V1028	181	V1524N-6X7	180	V1904	63	V1997	157	V2091	158	V2152	159
V1029	181	V1524N-8X9	180	V1905	62	V1998	157	V2092	158	V2153	159
V1030	181	V1524N-10X11	180	V1906	62	V1999	157	V2094	158	V2154	159
V1031	181	V1524N-12X13	180	V1907	62	V2000	157	V2095	158	V2155	159
V1135	213	V1524N-14X15	180	V1908	62	V2001	157	V2096	158	V2156	159
V1138	211	V1524N-16X17	180	V1909	63	V2002	157	V2097	158	V2157	159
V1208	186	V1524N-18X19	180	V1917	146	V2003	157	V2098	158	V2158	159
V1209	186	V1524N-20X22	180	V1918	146	V2004	157	V2099	158	V2159	159
V1212	213	V1524N-21X23	180	V1919	147	V2014	131	V2100	158	V2160	159
V1213	215	V1524N-24X27	180	V1963-3	265	V2016N	136	V2101	158	V2161	159
V1214	214	V1524N-25X28	180	V1963-4	265	V2017N	136	V2102	158	V2162	159
V1215	214	V1524N-30X32	180	V1963-5	265	V2018N	136	V2103	158	V2163	159
V1216	214	V1571	304	V1963-6	265	V2019N	136	V2104	158	V2165	159
V1217	214	V1584	303	V1963-7	265	V2020N	136	V2105	158	V2167	159
V1218	214	V1637	187	V1963-22	265	V2027	211	V2106	158	V2168	159
V1219	214	V1657	303	V1963-25	265	V2028	210	V2107	158	V2169	159
V1220	214	V1698	186	V1963/28	264	V2029	210	V2108	143	V2170	159
V1221	214	V1699	186	V1963N-6	264	V2030	210	V2109	164	V2171	159
V1222	214	V1700	186	V1963N-8	264	V2031-T15	211	V2110	164	V2172	159
V1281	273	V1701	186	V1963N-9	264	V2031-T20	211	V2111	167	V2173	160
V1283	215	V1702	186	V1963N-A	264	V2031-T25	211	V2112	272	V2174	160
V1293	170	V1703	186	V1963N-B	264	V2031-T30	211	V2113	159	V2175	160
V1301	220	V1704	186	V1963N-C	264	V2059	159	V2114N	143	V2176	160
V1304	221	V1706N	172	V1963N-E	264	V2060	159	V2115N	142	V2177	160
V1345	223	V1707	225	V1963N-F	264	V2061	210	V2116N	143	V2178	160
V1368N	215	V1711-1	281	V1963N-G	264	V2062	210	V2117N	142	V2179	160
V1369	218	V1711N	281	V1963N-H	264	V2063	210	V2118N	142	V2180	160
V1371	218	V1713	221	V1963N-M	264	V2064	210	V2119N	137	V2181	160
V1371-1	218	V1714	220	V1963N-R	264	V2065	158	V2120N	137	V2182	160
V1371-2	218	V1715	221	V1963N-S	265	V2066	159	V2121	159	V2183	160
V1371-3	218	V1722	254	V1963N-T	265	V2067	159	V2122	159	V2184	160
V1371-4	218	V1728	288	V1963N-X	265	V2068	159	V2123	159	V2185	127
V1371-5	218	V1740	241	V1970	50	V2069	158	V2124	159	V2186	127
V1371-6	218	V1741	241	V1976	128	V2070	158	V2126	159	V2187	127
V1372	215	V1764	241	V1977	128	V2071	143	V2128	159	V2188	127
V1409	193	V1781	171	V1978	128	V2072	158	V2129	159	V2189	127
V1410	193	V1782	288-289, 292	V1979	128	V2073	158	V2130N	128	V2194	138
V1423	304	V1783	214	V1980	128	V2074	158	V2132	159	V2195	138
V1438	241	V1787	224	V1981	128	V2075	158	V2133	159	V2196	157
V1446	223	V1788	224	V1982	128	V2076	158	V2134	159	V2197	157
V1461N	178	V1789	224	V1983	128	V2077	158	V2135	159	V2201	147
V1461N-6X7	178	V1790	224	V1984	128	V2078	158	V2136	128	V2202	161
V1461N-8X9	178	V1801	224	V1985	128	V2079	158	V2137	159	V2203	161
V1461N-10X11	178	V1802	203	V1986	128	V2080	158	V2138	128	V2204	161
V1461N-12X13	178			V1987	128	V2081	158	V2139	128	V2205	161

# Nummern- / Seiten-Verzeichnis



VIGOR-No.	Seite	VIGOR-No.	Seite	VIGOR-No.	Seite	VIGOR-No.	Seite	VIGOR-No.	Seite	VIGOR-No.	Seite
V2206	161	V2281N	141	V2394	225	V2442N	128	V2503	193	V2578N	157
V2207	161	V2282N	141	V2395	225	V2443N	128	V2504	193	V2579N	156
V2208	161	V2283N	141	V2396	225	V2444N	128	V2505	193	V2580N	156
V2209	161	V2284N	141	V2397	59	V2445N	128	V2506	193	V2581N	156
V2210	161	V2285N	141	V2400	177	V2446N	128	V2507	193	V2582N	157
V2211	161	V2286N	137	V2404N	150	V2447N	128	V2508	215	V2584N	156
V2212	161	V2287N	137	V2404N-6	165	V2452N	131	V2509	215	V2585N	156
V2213	161	V2288N	137	V2404N-7	165	V2453N	126	V2511N	273	V2586N	156
V2214	161	V2289N	138	V2404N-8	165	V2454N	131	V2512	303	V2587N	156
V2215	161	V2290N	138	V2404N-9	165	V2455N	130	V2513	303	V2588N	156
V2216	161	V2291N	138	V2404N-10	165	V2456N	130	V2514	303	V2589N	156
V2217	161	V2292N	138	V2404N-11	165	V2457N	130	V2515	303	V2590N	156
V2218	161	V2293N	138	V2404N-12	165	V2458N	126	V2516	303	V2591N	156
V2219	161	V2294N	138	V2404N-13	165	V2459N	263	V2517	65	V2592N	157
V2220	161	V2295N	139	V2404N-14	165	V2460N	144	V2518	65	V2593N	129
V2221	161	V2296N	139	V2404N-15	165	V2461N	173	V2519	65	V2594N	129
V2222	161	V2297N	139	V2404N-16	165	V2462	63	V2520	65	V2595N	128
V2223	161	V2298N	139	V2404N-17	165	V2464	177	V2521	273	V2596N	128
V2224	161	V2299N	139	V2404N-19	165	V2465N	156	V2522	298	V2597N	129
V2225	161	V2300N	139	V2404N-21	165	V2466	288	V2523	308	V2598N	156
V2226	161	V2301N	139	V2404N-22	165	V2467	288	V2533N	127	V2599N	156
V2227	161	V2302N	139	V2404N-24	165	V2471	298	V2534N	127	V2600N	156
V2228	161	V2303N	139	V2404N-27	165	V2472	298	V2535N	127	V2603N	156
V2229	161	V2305N	133	V2404N-30	165	V2473	298	V2536N	127	V2613N	137
V2230	161	V2311N	136	V2404N-32	165	V2474	298	V2537N	127	V2614N	137
V2231	161	V2312N	136	V2413N	127	V2475	298	V2538N	127	V2615N	137
V2232	161	V2313N	136	V2414N	123	V2477	301	V2539N	127	V2616N	142
V2233	161	V2314N	136	V2415N	127	V2478	301	V2540	288	V2626	225, 288
V2234	304	V2315N	136	V2416N	127	V2481	299	V2542	177	V2627	222
V2235	304	V2317N	168	V2417N	127	V2482	193	V2551	288	V2628	212
V2249	291	V2318N	167	V2418N	127	V2483	193	V2552	288	V2629	212
V2250	291	V2319N	167	V2419N	127	V2484	193	V2553	288	V2630	212
V2256N	168	V2320N	168	V2420N	127	V2485	193	V2554	288	V2631	299
V2257	298	V2321N	168	V2421N	127	V2486	193	V2555	288	V2632	299
V2261N	136	V2322N	167	V2422N	127	V2487	215	V2556	288	V2639	299
V2262N	136	V2323N	168	V2423N	127	V2488	215	V2558	288	V2640	299
V2263N	136	V2324N	168	V2424N	127	V2489	193	V2559	288	V2641	212
V2264N	136	V2325N	168	V2425N	127	V2490	193	V2561N	156	V2643	212
V2265N	136	V2326N	168	V2426N	127	V2491	218	V2562N	156	V2645	272
V2266N	136	V2327N	168	V2427N	129	V2492	218	V2563N	156	V2647N	164
V2267N	136	V2328N	168	V2428N	129	V2493	218	V2564N	156	V2648	302
V2268N	136	V2329N	168	V2429N	129	V2494	218	V2565N	156	V2662	213
V2269N	136	V2331N	168	V2430N	129	V2495	218	V2566N	156	V2663	213
V2270N	136	V2332N	168	V2431N	129	V2496	145	V2567N	156	V2664	213
V2271N	136	V2333N	168	V2432N	129	V2497	193	V2568N	156	V2665	213
V2272N	136	V2334N	168	V2433N	129	V2498	193	V2569N	156	V2667N	155
V2273N	136	V2335N	168	V2434N	129	V2499	256	V2570N	156	V2687	170
V2274N	136	V2336N	168	V2435N	129	V2499-A	256	V2571N	156	V2699N	127
V2275N	136	V2337N	168	V2436N	129	V2499-B	256	V2572N	156	V2700N	127
V2276N	136	V2338	246	V2437N	129	V2499-C	256	V2573N	155	V2701N	127
V2277N	136	V2379N	29	V2438N	129	V2499-D	256	V2574N	156	V2705	184
V2278N	136	V2393	60	V2439N	129	V2499-F	256	V2575N	163	V2712N	30
V2279N	141	V2393-S	60	V2440N	129	V2501	193	V2576N	164	V2722	127
V2280N	141	V2393-XD	60	V2441N	129	V2502	193	V2577N	164	V2723	127

VIGOR-No.	Seite	VIGOR-No.	Seite	VIGOR-No.	Seite	VIGOR-No.	Seite	VIGOR-No.	Seite	VIGOR-No.	Seite
V2724	137	V2845	333	V2913	372	V3035	365	V3132	324, 328, 408	V3275	328
V2725	137	V2846	325, 353	V2914	372	V3036	365	V3133	324, 328	V3277N	174
V2726	137	V2847	325, 352	V2915	372	V3039	333, 400	V3134	323	V3287	398, 401
V2727	137	V2849	350, 364	V2917	374	V3040	333, 400	V3135	328, 374	V3309	225
V2728	137	V2850	326	V2920	402	V3044	374	V3136	328, 374	V3330	210
V2729	137	V2851	327	V2922	364-365	V3045	372	V3137	328, 374	V3331	210
V2730	157	V2853	330	V2923	372	V3046	372	V3140	365	V3332	210
V2731	157	V2854	323, 350, 352-353	V2924N	168	V3047	372	V3141	325	V3333	210
V2732	157	V2858N	402	V2936	413	V3048	372	V3142	368	V3334	210
V2733	157	V2859	338	V2937	412	V3049	372	V3147	364	V3335	210
V2734	157	V2860	335, 351	V2941	126	V3050	374	V3148	364	V3336	210
V2735	157	V2861	339	V2942	413	V3051	374	V3149	396, 399-400	V3337	210
V2762	301-302	V2862	339	V2945	361	V3052	374	V3199	323	V3338	210
V2781	199	V2863	339	V2946	361	V3053	358, 368, 371	V3205	330	V3339	210
V2782	199	V2864	335, 351	V2947	360	V3055	368	V3206	330	V3340	210
V2783	199	V2867N	331, 414-415	V2948	360	V3055-275	369	V3207	328	V3341	210
V2788	206	V2869	322, 355	V2949	360	V3056	357-358, 368, 371	V3208	328, 375	V3342	209
V2788-4.0	206	V2871	365	V2950	360	V3057	368	V3209	328	V3343	209
V2788-3.2	206	V2872	365	V2961	360	V3060	332, 334	V3210	328	V3344	210
V2788-6.4	206	V2873	322	V2962	360	V3070	334	V3212	373	V3366	189
V2788-4.8	206	V2874	324, 414-415	V2963	360	V3071	334	V3213	373	V3367	189
V2789N	290	V2879	397	V2964	360	V3087	400	V3214	373	V3368	189
V2790N	222	V2881	396, 400	V2965	360	V3088	400	V3215	373	V3369	189
V2795	229	V2882	396, 400	V2966	360	V3090	401	V3216	324	V3370	189
V2800-OEL	326	V2883	396-397, 400	V2967	360	V3091	396, 400	V3217	322	V3381	262
V2804	183	V2885	355, 368	V2968	360	V3092	324, 408	V3219	328, 375	V3391	189
V2805	183	V2886	373	V2969	360	V3100	373	V3220	328, 375	V3392	189
V2806	183	V2889	396	V2971	360	V3101	373	V3222	407, 414-415	V3403	371
V2807	183	V2890	398, 401	V2972	360	V3102	373	V3224	413	V3404	371
V2808	183	V2891	369	V2973	360	V3103	373	V3225	413	V3405	371
V2809	183	V2892	369	V2974	360	V3105	396	V3226	413	V3427N	192
V2810	183	V2893	355, 369	V2975	361	V3106	396, 399-400, 413	V3231	407	V3431	408, 413
V2811	183	V2894	355, 369	V2976	361	V3107	396, 413	V3232	404, 407	V3433	397, 400
V2812	183	V2895	355, 369	V2977	361	V3108	396, 399-400	V3233	412	V3434	408
V2813	183	V2896	369	V2978	361	V3109	396, 400	V3234	412	V3437	408
V2814	183	V2897	355, 369	V2979	361	V3110	400	V3235	412	V3438	408
V2817	183	V2898	355, 369	V2980	361	V3112	325	V3236	412	V3439	408
V2818	183	V2899	355, 369	V2981	361	V3120	325	V3237	412	V3440	408
V2820	181	V2900	355, 369	V2992	331	V3123	323	V3238	413	V3441	229
V2821	180	V2901	355, 369	V2993	331	V3124	322-323	V3259	411	V3451	225
V2822	180	V2902	369	V2994	331	V3125	323	V3260	411	V3541	213
V2823	180	V2903	355, 369	V2999	372	V3126	323, 328, 330, 365, 412	V3261	411	V3551N	309
V2824	180	V2904	369	V3000	372	V3127	323, 328, 412	V3262	411	V3551N-ABS	309
V2825	180	V2905	369	V3001	372	V3128	322-324	V3263	407, 410-411	V3551N-PE	309
V2826	180	V2906	369	V3002	372	V3129	323, 355, 372	V3264	404, 407	V3551N-PP	309
V2827	180	V2907	369	V3008	330	V3130	323-324	V3265	404, 407	V3551N-PS	309
V2828	180	V2908	369	V3009	322	V3131	324	V3266	404-405, 412-413	V3551N-W	309
V2828	180	V2909	369	V3010	322			V3267	404-405, 412-413	V3562	187
V2829	180	V2910	327	V3011	322					V3563	303
V2830	180	V2912	370	V3012	322					V3571	262
V2831	180			V3013	398, 401					V3582	329
V2832	180			V3018	323-324					V3597	186
V2833	180			V3021	401					V3598	186
V2837	106			V3033	365						
V2838	106										

# Nummern- / Seiten-Verzeichnis



VIGOR-No.	Seite	VIGOR-No.	Seite	VIGOR-No.	Seite	VIGOR-No.	Seite	VIGOR-No.	Seite	VIGOR-No.	Seite
V3599	186	V3739	202	V3763	410	V4229	324	V4381-4	279	V4472N	179
V3600	186	V3741	150	V3764	410	V4230	109	V4383	276	V4473N	179
V3601	186	V3750	410	V3765	410	V4231	109	V4384	276	V4473N-6	179
V3602	186	V3753	336, 348-349	V3863	315	V4233	266	V4385N	276	V4473N-7	179
V3607	184	V3755	335	V3867	409	V4235	213	V4398N	164	V4473N-8	179
V3609	186	V3758	336, 348-349	V3869	327	V4241	239	V4399	286	V4473N-9	179
V3610	186	V3760-0	283	V3870	327	V4242	324	V4411	278	V4473N-10	179
V3612	329	V3760-0-DISC	283	V3871	331, 335-336, 341, 343, 345, 359	V4243	326	V4413	274	V4473N-11	179
V3613	186	V3760-A	282	V3873	331, 335-336, 341, 343	V4244	326	V4414	274	V4473N-12	179
V3614	325	V3760-A1	283	V3874	331, 335-336, 341, 343	V4245	326	V4415	274	V4473N-13	179
V3615	303	V3760-B	282	V3898	229	V4246	326	V4416	287	V4473N-14	179
V3634	408	V3760-B1	283	V3899	229	V4248	315	V4416-1	287, 289	V4473N-15	179
V3635	181	V3760-C	282	V4111	62	V4249	315	V4416-2	287, 289	V4473N-16	179
V3636	181	V3760-D	282	V4112	62	V4250	315	V4416-3	287, 289	V4473N-17	179
V3649	358, 371	V3760-E	282	V4113	276	V4251	324	V4416-4	287, 289	V4473N-18	179
V3650	371	V3760-F	282	V4114	276	V4252	324	V4416-5	287	V4473N-19	179
V3651N	131	V3760-F1	283	V4115	276	V4253	324	V4418	189	V4473N-20	179
V3652N	143	V3760-G	282	V4122	63	V4254	324	V4419	189	V4473N-21	179
V3653	232	V3760-H6	283	V4126N	315	V4255	325	V4420	189	V4473N-22	179
V3661	315	V3760-H7	283	V4130	105	V4274	222	V4421	189	V4473N-24	179
V3670N	309	V3760-IV	283	V4153	308	V4275	222	V4422	189	V4473N-27	179
V3671N	309	V3760-J	282	V4154	308	V4278	240	V4425N	176	V4473N-30	179
V3672N	309	V3760-K	283	V4155	308	V4279	240	V4432/6	188	V4473N-32	179
V3673N	309	V3760-K1	283	V4156	308	V4303	192	V4433	188	V4473N-36	179
V3676N	309	V3760-K2	283	V4157	308	V4304	267	V4434	188	V4476-1	379
V3677N	309	V3760-M	283	V4158	308	V4305	267	V4435	188	V4476N	377
V3678	410	V3760-N	283	V4159	308	V4306	267	V4436	188	V4476N-1	378
V3680	351	V3760-P	283	V4160	308	V4308	222	V4437	188	V4476N-2	378
V3681	276	V3760-P1	283	V4161	308	V4309	296	V4438	188	V4477	166
V3682	276	V3760-Q	283	V4163	308	V4310N	219	V4451	255	V4478	166
V3683	276	V3760-R	283	V4164	308	V4311	130	V4451-1	255	V4481	51
V3684	276	V3760-S	283	V4165	308	V4312	130	V4451-2	255	V4481-X	52
V3685	276	V3760-T	283	V4166	308	V4313	130	V4451-3	255	V4481-X-4	60
V3686	276	V3760-V	283	V4188	105	V4314	142	V4451-4	255	V4481-X-5	64
V3687	276	V3760-VW	283	V4192	266	V4315	142	V4451-5	255	V4481-X/375	38
V3688	276	V3760-X	283	V4196	205	V4316	142	V4451-6	255	V4481-X/466	39
V3689	276	V3760-Z	283	V4199	192	V4317	164	V4451-7	255	V4481-X/499	40
V3690	276	V3760-1	282	V4200	192	V4318	164	V4451-8	255	V4481-XD	53
V3691	276	V3760-2	282	V4201	275	V4319	164	V4451-9	255	V4481-XD-1	63
V3729	265	V3760-3	282	V4201-1	275	V4322	237	V4451-10	255	V4481-XD-2	62
V3731	336	V3760-4	282	V4202	265	V4324	254	V4451-11	255	V4481-XD-3	62
V3732	336	V3760-5	282	V4218	326	V4324-1	254	V4451-12	255	V4481-XD-4	60
V3734N	122	V3760-6	282	V4219	31	V4324-2	254	V4451-13	255	V4481-XD-5	64
V3735	206	V3760-7	282	V4220	327	V4325	269	V4451-14	255	V4481-XD/469	42
V3735-M10	206	V3760-8	283	V4221	192	V4326N	257	V4451-15	255	V4481-XD/775	43
V3735-M5	206	V3760-9	283	V4222	192	V4342	328	V4451-16	255	V4481-XXL	56
V3735-M6	206	V3760-11	282	V4223	192	V4352	379	V4451-17	255	V4481-XXL/929	44
V3735-M8	206	V3760-12	282	V4224	192	V4353	379	V4451-18	255	V4491	341
V3735-4.0	206	V3760N	282	V4225	192	V4354	379	V4451-19	255	V4491-A	341
V3735-3.2	206	V3761	409	V4227	239	V4369	275	V4451-20	255	V4493	341
V3735-6.4	206	V3762	409	V4228	239	V4381	279	V4451-21	255	V4499	409
V3735-4.8	206					V4381-1	279	V4451-22	255	V4500	409
V3738	202					V4381-2	279	V4451-23	255	V4521	116
V3738-S	202					V4381-3	279	V4461	268	V4542	36

VIGOR-No.	Seite	VIGOR-No.	Seite	VIGOR-No.	Seite	VIGOR-No.	Seite	VIGOR-No.	Seite	VIGOR-No.	Seite
V4545	405, 407	V4602-1	411	V4646S-14	247	V4814-3	62	V4941N-R9	270	V5017-L	101
V4546	405, 407	V4603	414	V4646S-15	247	V4814-4	63	V4941N-1	270	V5018	119
V4547	405, 407	V4604	415	V4646S-16	247	V4884	154	V4941N-2	270	V5019	196
V4548	405, 407	V4605	406	V4646S-17	247	V4884-01	154	V4941N-3	270	V5020	197
V4549	405, 407	V4606	406	V4646S-18	247	V4885	219	V4941N-4	270	V5024	168
V4550	404-405, 415	V4607	406	V4646S-19	247	V4891	311	V4941N-5	270	V5025	168
		V4608	406	V4651	222	V4891-1	311	V4941N-10	270	V5026	168
V4551	323	V4609	406, 411	V4655	187	V4891-1.0	310	V4941N-11	270	V5027	342, 345, 349, 356
V4552	323	V4610	406	V4661	213	V4891-2	311	V4941N-19T	270		
V4553	323	V4614	332, 348	V4661-1	213	V4891-3	311	V4941N-20	270	V5042	186
V4554	407	V4629	331, 347	V4663	215	V4891-3.5	313	V4941N-22	270	V5043	186
V4555	407	V4629-1	331, 348	V4664	190	V4891-3.5-1	313	V4941N-245	270	V5044	186
V4556	407	V4631	119	V4665	190	V4891-3.5-2	313	V4942	191	V5045	215
V4560	34	V4632	119	V4666	190	V4891-3.5-3	313	V4944-REP	124	V5048	272
V4561	35	V4633	119	V4667	186	V4891-3.5-4	313	V4944-S	124	V5055	33
V4562	404-405	V4634	404-405	V4668	278	V4891-3.5-5	313	V4944-XS	125	V5058	390
V4563	404-405	V4635	412	V4680	351-353, 356	V4891-3.5-6	313	V4945-REP	135	V5058-L	390
V4564	404-405	V4636N	319			V4891-4	311	V4945-S	135	V5062	391
V4565	404, 414	V4637N	204	V4690	221	V4891-5	312	V4946-REP	154	V5062-L	391
V4566	405	V4638	249	V4697	287	V4891-6	312	V4946-S	154	V5064	390
V4569	406	V4640	203	V4697-1	287	V4891-7	312	V4961	181	V5066	393
V4570	406	V4641	204	V4697-2	287, 289	V4891-8	312	V4962	181	V5066-L	393
V4571	406	V4642	317	V4699	330	V4891-9	312	V4963	181	V5068	99
V4572	406	V4646	247	V4699-1	330	V4891-10	312	V4964	181	V5068-L	99
V4573	406	V4646M-8	247	V4699-2	330	V4891-10.0	314	V4965	181	V5070	100
V4574	406	V4646M-9	247	V4699-3	330	V4891/6	312	V4966	181	V5070-L	100
V4575	406	V4646M-10	247	V4699-4	330	V4893	64	V4971	95	V5072	101
V4577	409	V4646M-11	247	V4699-5	330	V4904	393	V4971-L	95	V5072-L	101
V4586	116	V4646M-12	247	V4699-6	330	V4904-L	393	V4973	95	V5075	98
V4594	334	V4646M-13	247	V4699-7	330	V4906N	392	V4973-L	95	V5075-L	98
V4594-1	334	V4646M-14	247	V4700-A	93	V4906N-L	392	V4975	95	V5077	98
V4596	328	V4646M-15	247	V4700-L	92, 346	V4908	390	V4975-L	95	V5077-L	98
V4597	328	V4646M-16	247	V4700-R	93	V4908-L	390	V4987	98	V5081	104
V4598	332, 347	V4646M-17	247	V4700-XL	92, 346	V4915	390	V4987-L	98	V5081-L	104
V4598-2	332, 348, 365	V4646M-18	247	V4700-XXL	93, 346, 355	V4915-L	390	V4989	99	V5085	104
		V4646M-19	247			V4921	391	V4989-L	99	V5085-L	104, 390
V4598-3	332, 334, 348	V4646N-8	247	V4701	275	V4921-L	391	V4991	99	V5087	104
		V4646N-9	247	V4708	191	V4930	286	V4991-L	99	V5087-L	104
V4598-4	332, 348	V4646N-10	247	V4709N	156	V4941N	270	V4995	99	V5091	97
V4598-10	332	V4646N-11	247	V4726	107	V4941N-BK	270	V4995-L	99	V5091-L	97
V4598-11	332	V4646N-12	247	V4727	107	V4941N-BL	270	V4999N	102	V5095	96
V4598-12	332, 334	V4646N-13	247	V4728	108	V4941N-M5	270	V4999N-L	102	V5095-L	96
V4598-13	332	V4646N-14	247	V4729	108	V4941N-R1	270	V5004	100	V5097	97
V4598-14	332	V4646N-15	247	V4737	204	V4941N-R10	270	V5004-L	100	V5097-L	97
V4598-15	332	V4646N-16	247	V4752	107	V4941N-R11	270	V5006	100	V5099	96
V4598-16	332	V4646N-17	247	V4753	107	V4941N-R12	270	V5006-L	100	V5099-L	96
V4598-20	332	V4646N-18	247	V4758	57	V4941N-R13	270	V5009	119	V5103	103
V4598-21	332	V4646N-19	247	V4800N	231	V4941N-R2	270	V5011	101	V5103-L	103
V4598-22	332	V4646S-8	247	V4813	54	V4941N-R3	270	V5011-L	101	V5109	107
V4598-30	332, 334, 348	V4646S-9	247	V4813-1	63	V4941N-R4	270	V5013	101	V5109-L	107
		V4646S-10	247	V4813-2	64	V4941N-R5	270	V5013-L	101	V5111N	114
		V4646S-11	247	V4814	55	V4941N-R6	270	V5015	102	V5111N-L	114
V4601	411	V4646S-12	247	V4814-1	62	V4941N-R7	270	V5015-L	102	V5115	106
V4602	411	V4646S-13	247	V4814-2	62	V4941N-R8	270	V5017	101	V5115-L	106

# Nummern- / Seiten-Verzeichnis



VIGOR-No.	Seite	VIGOR-No.	Seite	VIGOR-No.	Seite	VIGOR-No.	Seite	VIGOR-No.	Seite	VIGOR-No.	Seite
V5128	347	V5531	250	V5639-24	208	V6000-3P1XL-X	67	V6000-053	87	V6029-1	300
V5156	46	V5548	395	V5649	290	V6000-3P2XL	68	V6000-054	87	V6029-2	300
V5158	47	V5548-L	395	V5650	199	V6000-3P2XL-X	68	V6000-055	88	V6029-3	300
V5168	350	V5549	348	V5660	263	V6000-04	78	V6000-055XL	88	V6030	217
V5169	360	V5549-1N	349	V5661	190	V6000-04XL	78	V6000-0676	82	V6030-12	217
V5169-A	363	V5550L	151	V5671N	231	V6000-05	84	V6000-0676-D	83	V6030-16	217
V5169-A45	363	V5550L-10	165	V5672	234	V6000-05S	84	V6000-0676-X	82	V6030-20	217
V5169-A55	363	V5550L-11	165	V5673	234	V6000-05SP	84	V6000-0676-XD	83	V6031	300
V5169-A70	363	V5550L-12	165	V5674	233	V6000-05SXL	84	V6000-0860	82	V6031-1	300
V5169-A76	363	V5550L-13	165	V5675	233	V6000-09	85	V6000-0860-X	82	V6031-2	300
V5169-A80	363	V5550L-14	165	V5676	259	V6000-010	85	V6000-0861	82	V6031-3	300
V5170	117	V5550L-15	165	V5677	242	V6000-011	76	V6000-0861-D	83	V6038	135
V5170-L	117	V5550L-16	165	V5678	243	V6000-015	84	V6000-0861-X	82	V6038-REP	135
V5175	109	V5550L-17	165	V5679M	250	V6000-015S	84	V6000-0861-XD	83	V6048	185
V5175-L	109	V5550L-18	165	V5680	250	V6000-015SP	84	V6000-01083-D	83	V6049	185
V5180	57, 62	V5550L-19	165	V5681	208	V6000-015SXL	84	V6000-01083-XD	83	V6068	197
V5182	168	V5550L-21	165	V5691	290	V6000-017	84	V6000-01357	82	V6082	138
V5183	168	V5550L-22	165	V5741N	358	V6000-017XL	84	V6000-01357-D	83	V6083	138
V5191	57, 62	V5550L-24	165	V5885	219	V6000-018	84	V6000-01357-X	82	V6084	139
V5202	122	V5550S	151	V5902	358, 373	V6000-018XL	84	V6000-01357-XD	83	V6085	139
V5420	337	V5550S-10	165	V5902-1	373	V6000-019	73	V6000-01541	82	V6086	139
V5421	337	V5550S-11	165	V5902-2	373	V6000-019XL	73	V6000-01541-X	82	V6087	139
V5422	337	V5550S-12	165	V5903-3	340	V6000-020	86	V6000-01725	82	V6088	139
V5423	338	V5550S-13	165	V5903N	340, 349	V6000-029	70	V6000-01725-D	83	V6089	139
V5424	338	V5550S-14	165	V5904	345	V6000-029XL	70	V6000-01725-X	82	V6090	139
V5425	337	V5550S-15	165	V5904-1	345	V6000-030	70	V6000-01725-XD	83	V6091	139
V5434	37	V5550S-16	165	V5904-3	345, 359	V6000-030XL	70	V6000-02036	82	V6092	139
V5436	125	V5550S-17	165	V5904-4	345, 359	V6000-031	71	V6000-02036-D	83	V6093	139
V5437	155	V5550S-18	165	V5905	344-345, 356	V6000-031XD	71	V6000-02036-X	82	V6094	139
V5461	175	V5550S-19	165	V5906	344-345	V6000-031XL	71	V6000-02036-XD	83	V6095	139
V5480	240	V5550S-21	165	V5906-1	343	V6000-032	73	V6000-02215	82	V6096	139
V5485N	190	V5550S-22	165	V5909	291	V6000-032XL	74	V6000-02215-X	82	V6097	139
V5488	242	V5550S-24	165	V5916	366	V6000-033	74	V6000-02404	82	V6098	139
V5489	48	V5554	352	V5916-XL	355, 367, 414-415	V6000-033XL	74	V6000-02404-X	82	V6099	139
V5489-1	63	V5554-2	353	V5916-1	366	V6000-035	75	V6000-02588	82	V6100	139
V5489-2	64	V5591	220	V5916-2	366	V6000-035XL	75	V6000-02588-D	83	V6101	139
V5489-3	62	V5601	191	V5922	263	V6000-036	80	V6000-02588-X	82	V6102	139
V5489-4	62	V5602	96	V5930	296, 298	V6000-036XL	80	V6000-02588-XD	83	V6103	139
V5489-5	64	V5602-L	96	V5931	297-298	V6000-037	77	V6008	135	V6104	139
V5493	199	V5603	102	V5932	297-298	V6000-040/4	85	V6012	154	V6105	139
V5494	200	V5603-L	102	V5933/3	298	V6000-041/4	86	V6012-REP	154	V6106	140
V5496	200	V5631	211	V6000-01	72	V6000-042	79	V6014	124	V6107	140
V5496-1	200	V5632	209	V6000-01XD	72	V6000-042XL	79	V6014-REP	124	V6108	140
V5497	200	V5633N	102	V6000-01XL	72	V6000-043	85	V6015	118	V6109	140
V5502	196	V5633N-L	102	V6000-02	75	V6000-044	80	V6015-L	118	V6110	140
V5505	169	V5634N	114	V6000-02XD	76	V6000-044XL	80	V6017	134	V6111	140
V5505-1/2	169	V5634N-L	114	V6000-02XL	76	V6000-046	78	V6018	134	V6112	140
V5505-1/4	169	V5636N	115	V6000-3	69	V6000-046XL	78	V6019	134	V6113	140
V5505-3/8	169	V5636N-L	115	V6000-03-X	69	V6000-047LR	88	V6028	299	V6114	140
V5512	242	V5637N	115	V6000-03XL	77	V6000-047M	88	V6028-1	299	V6115	140
V5513	289	V5637N-L	115	V6000-03XL	77	V6000-048	84	V6028-2	299	V6116	140
V5513-1	289	V5638N	117	V6000-03XL	77	V6000-050	86	V6028-3	299	V6117	140
V5513-2	289	V5638N-L	117	V6000-3P1XL	67	V6000-051	86	V6028-4	299	V6118	140
V5513-3	289	V5639	208			V6000-052	87	V6029	300	V6119	140

VIGOR-No.	Seite	VIGOR-No.	Seite	VIGOR-No.	Seite	VIGOR-No.	Seite	VIGOR-No.	Seite	VIGOR-No.	Seite
V6120	140	V6221	58	V6510C-40	202	V6741	261	V6817-L	113	V7019-H17	166
V6121	140	V6222	100	V6510D-12	19, 202	V6742	244	V6818	113	V7019-H19	166
V6122	140	V6222-L	100	V6510D-19	19, 202	V6752-8	182	V6818-L	113	V7019-H5	166
V6123	140	V6230-5	216	V6510D-40	202	V6752-9	182	V6821	110	V7019-H6	166
V6124	140	V6230-7	216	V6554	233	V6752-10	182	V6821-L	110	V7019-H8	166
V6125	140	V6309	296	V6591	329	V6752-11	182	V6822	110	V7026	380
V6126	140	V6311	296	V6592	329	V6752-12	182	V6822-L	110	V7026-1	381
V6127	140	V6312/10	297	V6605	244	V6752-13	182	V6824	339	V7026-2	382
V6128	140	V6393	60	V6606	244	V6752-14	182	V6831	116	V7027	342
V6129	140	V6393-S	60	V6611/4	185	V6752-15	182	V6831-L	116	V7030	383
V6130	140	V6394	59	V6612N	155	V6752-16	182	V6899N	232	V7030-2	384
V6131	140	V6395	58	V6612N-REP	155	V6752-17	182	V6905	235	V7037-IP10	128
V6137	141	V6396	58	V6614N	125	V6752-18	182	V6906	234	V7037-IP15	128
V6138	141	V6397	59	V6614N-REP	125	V6752-19	182	V6906-10	234	V7037-IP20	128
V6139	141	V6398	57	V6632	283, 285	V6752/5	182	V6907	237	V7037-IP25	128
V6140	141	V6412/4	149	V6633	283, 285	V6752/12	182	V6907-1	237	V7037-IP27	128
V6141	141	V6435	245	V6634	283, 285	V6799	205	V6917	292	V7037-IP30	128
V6142	141	V6435-XL	245	V6635	283, 285	V6800-50	226	V6917-REP	292	V7037-IP8	128
V6143	141	V6436-L	245	V6636	285	V6800-75	226	V6952	220	V7037-IPR10	129
V6144	141	V6436-M	245	V6638N	135	V6801-65	227	V6956	317	V7037-IPR15	129
V6145	141	V6436-XL	245	V6638N-REP	135	V6802	226	V6973	246	V7037-IPR20	129
V6146	141	V6436-XXL	245	V6643	108	V6803-75	226	V6973-1	246	V7037-IPR25	129
V6147	141	V6452	316	V6643-L	108	V6803-100	226	V7001	306	V7037-IPR27	129
V6148	141	V6452-H6	316	V6650	117	V6804	227	V7001/4	306	V7037-IPR30	129
V6149	141	V6452-H7	316	V6650-L	117	V6805	227	V7002-14	260	V7037-IPR8	129
V6150	65	V6452-H8	316	V6685-1/20	61	V6806	227	V7002-16	260	V7037-T8H	128
V6151	141	V6452-1	316	V6685-2/20	61	V6807	111	V7002-18	260	V7050	335
V6152	141	V6452-5	316	V6685-3/10	61	V6807-L	111	V7002-20.8	260	V7055-H10	162
V6153	141	V6452-6	316	V6685-4/10	61	V6807-4	225	V7002/4	260	V7055-H12	162
V6154	141	V6452-16	316	V6685H/5	61	V6808	112	V7010-125K80	248	V7055-H14	162
V6155	141	V6452-17	316	V6685H-2/20	61	V6808-L	112	V7015N	118	V7055-H5	162
V6156	141	V6452-18	316	V6685H-3/10	61	V6809	111	V7015N-L	118	V7055-H6	162
V6157	141	V6452-19	316	V6685H-4/10	61	V6809-L	111	V7017	153	V7055-H7	162
V6158	141	V6452-21	316	V6686/5	61	V6809-4	225	V7017-T30	165	V7055-H8	162
V6159	141	V6452-22	316	V6687/5	61	V6810	111	V7017-T40	165	V7055-IP40	160
V6160	141	V6452-24	316	V6687H/5	61	V6810-L	111	V7017-T45	165	V7055-IP45	160
V6161	141	V6452-250	316	V6688	61	V6810-115K40	248	V7017-T50	165	V7055-IP50	160
V6194	141	V6468	243	V6688-XD	61	V6810-115K60	248	V7017-T55	165	V7055-IP55	160
V6200	217	V6500-140	207	V6688-XL	61	V6810-115K80	248	V7017-T60	165	V7055-IP60	160
V6200-2	217	V6500-160	207	V6688H	61	V6810-125K60	248	V7017-T70	165	V7055-IPR40	160
V6200-3	217	V6501-180	207	V6688H-XD	61	V6811	113	V7017-T80	165	V7055-IPR45	160
V6200-4	217	V6502-200	207	V6688H-XL	61	V6811-L	113	V7018	152	V7055-IPR50	160
V6200-5	217	V6503-200	207	V6689	59	V6811-115	248	V7018-M10	166	V7055-IPR55	160
V6200-6	217	V6504-250	208	V6721	97	V6812	114	V7018-M12	166	V7055-IPR60	160
V6200-7	217	V6510-10/4	201	V6721-L	97	V6812-L	114	V7018-M14	166	V7055-T20	161
V6200-8	217	V6510-19/4	201	V6722	98	V6813	112	V7018-M16	166	V7055-T25	161
V6202	132	V6510A-10	19, 201	V6722-L	98	V6813-L	112	V7018-M18	166	V7055-T27	161
V6210-4	216	V6510A-19	19, 201	V6723	97	V6814	112	V7018-M5	166	V7055-T30	161
V6210-10	216	V6510A-40	201	V6723-L	97	V6814-L	112	V7018-M6	166	V7055-T40	161
V6220-10	217	V6510B-10	19, 201	V6724	109	V6815N	115	V7018-M8	166	V7055-T40H	160
V6220-16	217	V6510B-19	19, 201	V6724-L	109	V6815N-L	115	V7019	152	V7055-T45	161
V6220-20	217	V6510B-40	201	V6726	108	V6816N	118	V7019-H10	166	V7055-T45H	160
V6220-29	217	V6510C-12	19, 202	V6726-L	108	V6816N-L	118	V7019-H12	166	V7055-T50	161
V6220/4	217	V6510C-19	19, 202	V6740	261	V6817	113	V7019-H14	166	V7055-T50H	160



# Nummern- / Seiten-Verzeichnis



VIGOR-No.	Seite	VIGOR-No.	Seite	VIGOR-No.	Seite	VIGOR-No.	Seite	VIGOR-No.	Seite	VIGOR-No.	Seite
V7055-T55	161	V7140-H12	163	V7212-M14	169	V7471L-9	280	V7514-14	127	V7723	392
V7055-T55H	160	V7140-H14	163	V7212-M16	169	V7471L-10	280	V7514-4.5	127	V7723-L	392
V7055-T60H	160	V7140-H5	163	V7212-M18	169	V7471L-11	280	V7514-5.5	127	V7724	392
V7061	340	V7140-H6	163	V7221	243	V7471L-12	280	V7514/13	123	V7724-L	392
V7071	340	V7140-H7	163	V7244	293	V7471S-7	280	V7514L-4	127	V7784	198
V7075-H17	163	V7140-H8	163	V7251	399	V7471S-8	280	V7514L-5	127	V7857	354
V7075-H19	163	V7140-T40	162	V7251-1	399	V7471S-9	280	V7514L-6	127	V7857-L	355
V7075-T60	162	V7140-T45	162	V7251-2	399-400	V7471S-10	280	V7514L-7	127	V7859	345
V7075-T70	162	V7140-T50	162	V7251-3	399	V7471S-11	280	V7514L-8	127	V7860	345
V7099	223	V7140-T55	162	V7251-4	399	V7471S-12	280	V7514L-9	127	V7862	364
V7099/2	223	V7140-T60	162	V7251-5	399	V7501/2	252	V7514L-10	127	V7865	375
V7100-H10	163	V7140-T70	162	V7252	397	V7512-8	156	V7514L-11	127	V7866	375
V7100-H11	163	V7143-10	236	V7259	293	V7512-9	156	V7514L-12	127	V7867	375
V7100-H12	163	V7154	395	V7261	394	V7512-10	156	V7514L-13	127	V7868	375
V7100-H13	163	V7154-L	395	V7261-L	394	V7512-11	156	V7514L-5.5	127	V7869	375
V7100-H5	163	V7154-1	359	V7263	391	V7512-12	156	V7520	103	V7870	375
V7100-H6	163	V7154-2	359	V7263-L	391	V7512-13	156	V7520-L	103	V7917	148
V7100-H7	163	V7154-4	359	V7265	394	V7512-14	156	V7524	253	V7919	148
V7100-H8	163	V7158	285	V7265-L	394	V7512-15	156	V7525	318	V7920-EP10	137
V7100-T20	162	V7158-1	285	V7267	391	V7512-16	156	V7538-9	136	V7920-EP12	137
V7100-T25	162	V7158-2	285	V7267-L	391	V7512-17	156	V7538-10	136	V7920-EP14	137
V7100-T27	162	V7158-3	285	V7270	394	V7512-18	156	V7538-11	136	V7920-EP16	137
V7100-T30	162	V7158-4	285	V7270-L	394	V7512-19	156	V7538-12	136	V7920-EP18	157
V7100-T40	162	V7158-5	285	V7273	395	V7512-20	156	V7538-13	136	V7920-EP20	157
V7100-T45	162	V7158-6	285	V7273-L	395	V7512-21	156	V7538-14	136	V7920-EP22	157
V7100-T50	162	V7158-7	285	V7275	400	V7512-22	156	V7538-15	136	V7920-EP24	157
V7100-T55	162	V7158-8	285	V7276	386	V7512-23	156	V7538-16	136	V7920-EP4	128
V7100-T60	162	V7181	305	V7276-2	387	V7512-24	156	V7538-17	136	V7920-EP5	128
V7100-T70	162	V7181-1	305	V7280	388	V7512-27	156	V7538-18	136	V7920-EP6	128
V7120	294	V7181-2	305	V7283	89	V7512-30	156	V7538-19	136	V7920-EP7	128
V7124	188	V7181-3	305	V7283/2	89	V7512-32	156	V7538/10	134	V7920-EP8	128
V7124-PH1	188	V7181-4	305	V7285	276	V7512-36	156	V7538L-9	136	V7980	364
V7124-PH2	188	V7181-5	305	V7286	276	V7512/17	145	V7538L-10	136	V8177	362
V7124-PH3	188	V7181-6	305	V7287	276	V7512L-10	156	V7538L-11	136	V8177-30	362
V7124-PZ1	188	V7200-H10	163	V7288	276	V7512L-11	156	V7538L-12	136	V8177-31.6	362
V7124-PZ2	188	V7200-H12	163	V7291	401	V7512L-12	156	V7538L-13	136	V8177-32	362
V7124-T20	188	V7200-H5	163	V7323	96	V7512L-13	156	V7538L-14	136	V8177-32.6	362
V7124-T25	188	V7200-H6	163	V7323-L	96	V7512L-14	156	V7538L-15	136	V8177-33.6	362
V7124-T30	188	V7200-H7	163	V7324	103	V7512L-15	156	V7538L-16	136	V8177-34	362
V7132N	284	V7200-H8	163	V7324-L	103	V7512L-16	156	V7538L-17	136	V8177-34.6	362
V7133	356	V7200-T40	162	V7385	274	V7512L-17	156	V7538L-18	136	V8177-35.6	362
V7133-2	357	V7200-T45	162	V7393	374	V7512L-18	156	V7538L-19	136	V8177-36	362
V7133-3	357	V7200-T50	162	V7401	286	V7512L-19	156	V7548	256	V8177-36.6	362
V7133-4	357	V7200-T55	162	V7402	249	V7512L-22	156	V7548-1	256	V8177-37.6	362
V7133-5	357	V7200-T60	162	V7403	249	V7514-4	127	V7600	195	V8177-38.6	362
V7133-6	357	V7200-T70	162	V7471	280	V7514-5	127	V7601-150	194	V8177-39.6	362
V7133-7	357	V7201	393	V7471-A	280	V7514-6	127	V7601-250	194	V8177-40.6	362
V7133-8	357	V7201-L	393	V7471-T	280	V7514-7	127	V7603/3	195	V8177-28.6	362
V7133-9	357	V7202	144	V7471-TL	280	V7514-8	127	V7614	195	V8177-29.6	362
V7133-10	357	V7212	169	V7471-TS	280	V7514-9	127	V7638	195	V8177-30.6	362
V7133N	356-357	V7212-H14	169	V7471-W	280	V7514-10	127	V7699	328	V8180	339
V7135	235	V7212-H17	169	V7471/17	280	V7514-11	127	V7700	328		
V7135-150	235	V7212-H19	169	V7471L-7	280	V7514-12	127	V7722	391		
V7140-H10	163	V7212-H21	169	V7471L-8	280	V7514-13	127	V7722-L	391		

**V1901/376**, EAN 4047728080293

Werkstattwagen mit Sortiment und Kunststoff-Arbeitsplatte



32

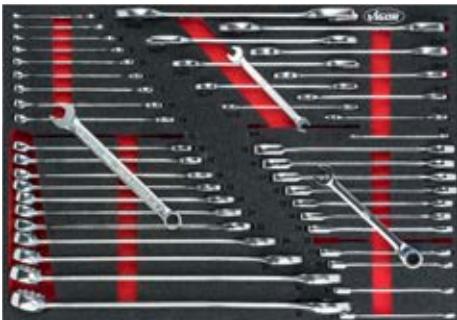
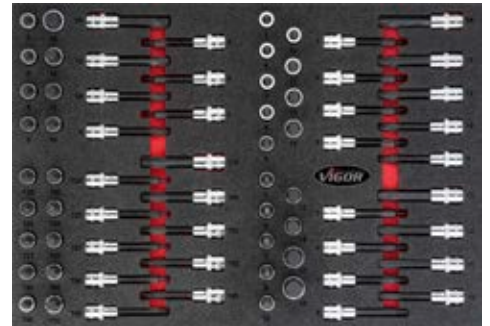

# Neuheiten-Übersicht



**V4481-XXL/929**, EAN 4047728**082303**

Extratiefer, Extrabreiter Werkstattwagen mit Sortiment und Edelstahl-Arbeitsplatte



44

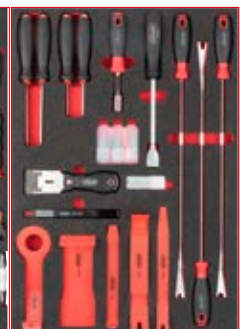
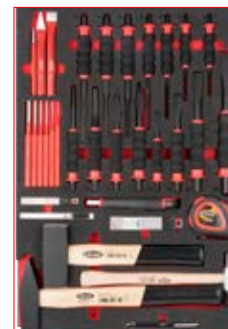
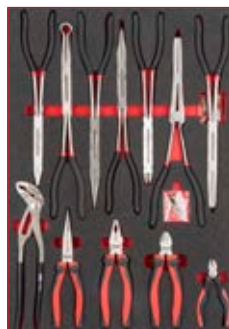
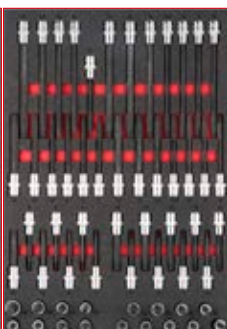
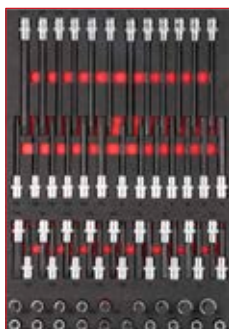
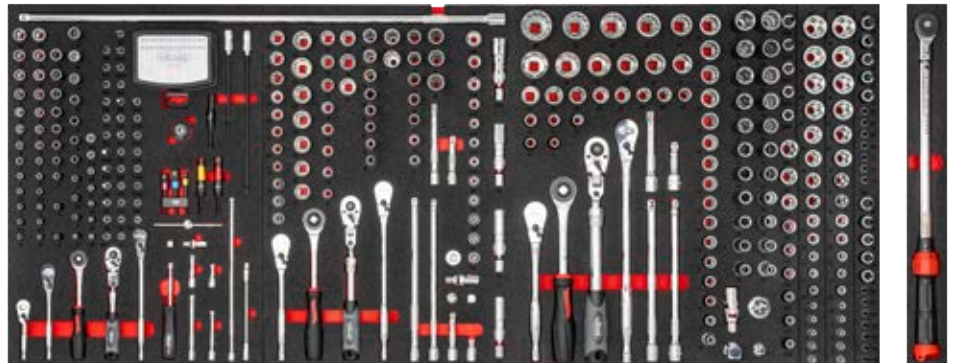

**V6688H / V6688H-XL / V6688H-XD**  
Trennblech Satz

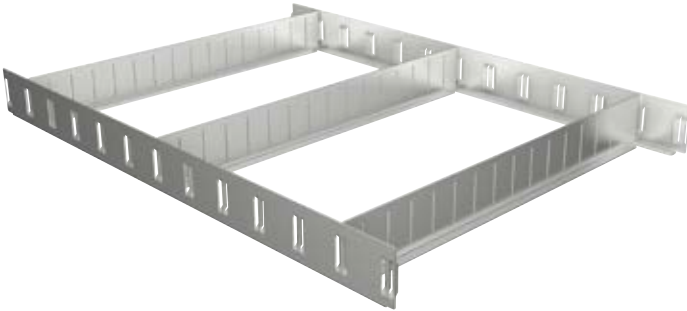

61

**V6685H / V6685H-3/10 / V6685H-4/10**  
Einteilblech Satz



61

**V6685H/5 / V6687H/5**  
Querträger Satz



61

**V6000-031XD**, EAN 4047728**081184**  
Schubladen-Unterschrank · extra tief · 5 Schubladen



71

**V6000-01XD**, EAN 4047728**081016**  
Schubladen-Unterschrank · extra tief · 7 Schubladen



72

**V6000-02XD**, EAN 4047728**081191**  
Doppelflügeltür-Unterschrank · extra tief



76

**V7324**, EAN 4047728**080262**

Schlagschrauber Steckschlüsseleinsatz Satz



103

**V6612N / V6614N / V6638N**

Teleskop Gelenk-Umschaltknarre



125

135

155

**V6412/4**, EAN 4047728**079518**

Stehbolzen-Ausdreher Satz



149

**V2404N**, EAN 4047728**080507**

Spiralnutenausdreher-Einsatz Satz



150

**V5461**, EAN 4047728**080323**

Steckschlüssel Satz



175

**V7601-150 / V7601-250**

Bithalter mit Magnetring · lang



194

**V7600**, EAN 4047728**079440**  
 Bithalter mit Gelenk



195

**V7603/3**, EAN 4047728**079471**  
 Steckschlüssel Adapter Satz



195

**V7614**, EAN 4047728**079457**  
 Steckschlüssel Adapter · mit Gelenk



195

**V7638**, EAN 4047728**079464**  
 Steckschlüssel Adapter · mit Gelenk



195

**V4640**, EAN 4047728**081726**  
 Schlauchschellen-Zange



203

**V5639 / V5639-24**  
 Rohrzanze



208

**V5632**, EAN 4047728080279  
VDE Werkzeug Satz



209

**V5679M**, EAN 4047728080637  
Magnet-Button Satz



250

**V5680**, EAN 4047728081436  
Magnethalter



250

**V7501/2**, EAN 4047728080255  
Video-Endoskop



252

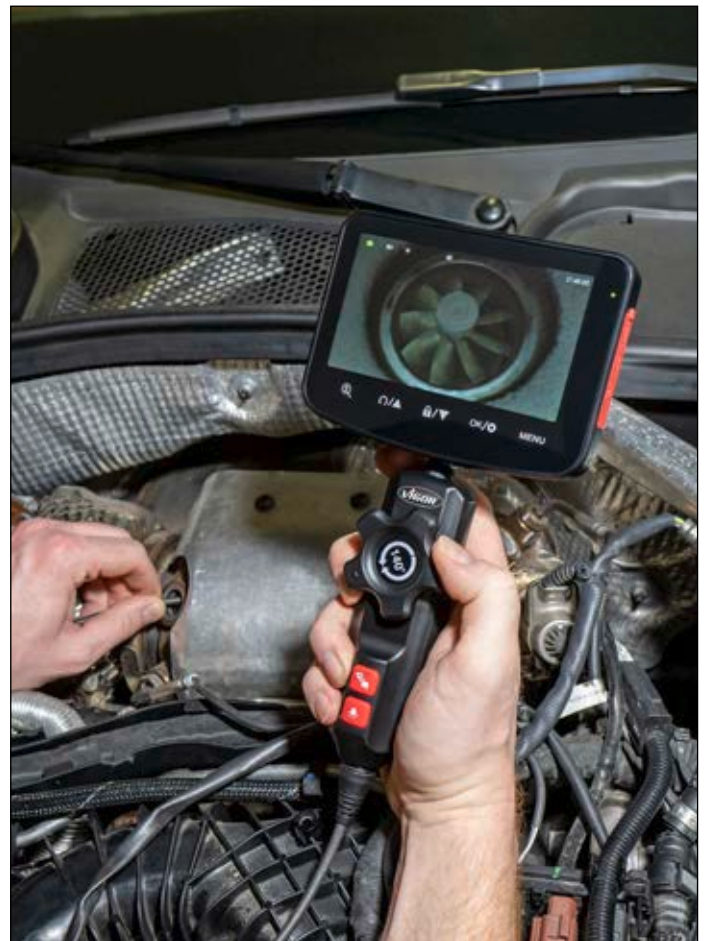

**V7524**, EAN 4047728081320  
Rauchgas-Leckagetester



253

**V4326N**, EAN 4047728079860  
Messkabel Satz



257

**V7002/4**, EAN 4047728079815  
Zündkerzen Steckschlüssel Satz



260

**V1963/28**, EAN 4047728081467  
Kühlsystem-Diagnose Satz



264

**V5932**, EAN 4047728079617  
Schlagschrauber Steckschlüsseinsatz · lang



297

**V5933/3**, EAN 4047728079624  
Schlagschrauber Steckschlüssel Satz · extra lang



298



**V4891-1.0**, EAN 4047728080217

Induktionsheizgerät



310

**V2800-OEL**, EAN 4047728081276

Hydrauliköl Power



326

**V8180**, EAN 4047728081979

Gegenhalteplatte Montage VAG



339

**V4491-A**, EAN 4047728081764

Zentrierhilfe Kompaktradlager



341

**V8177**, EAN 4047728081771

Zug- und Druckhülsen Satz



362

**V4476N-1**, EAN 4047728081597  
Federspanner Vorspanneinheit



378

**V4476N-2**, EAN 4047728081603  
Erweiterungssatz



378

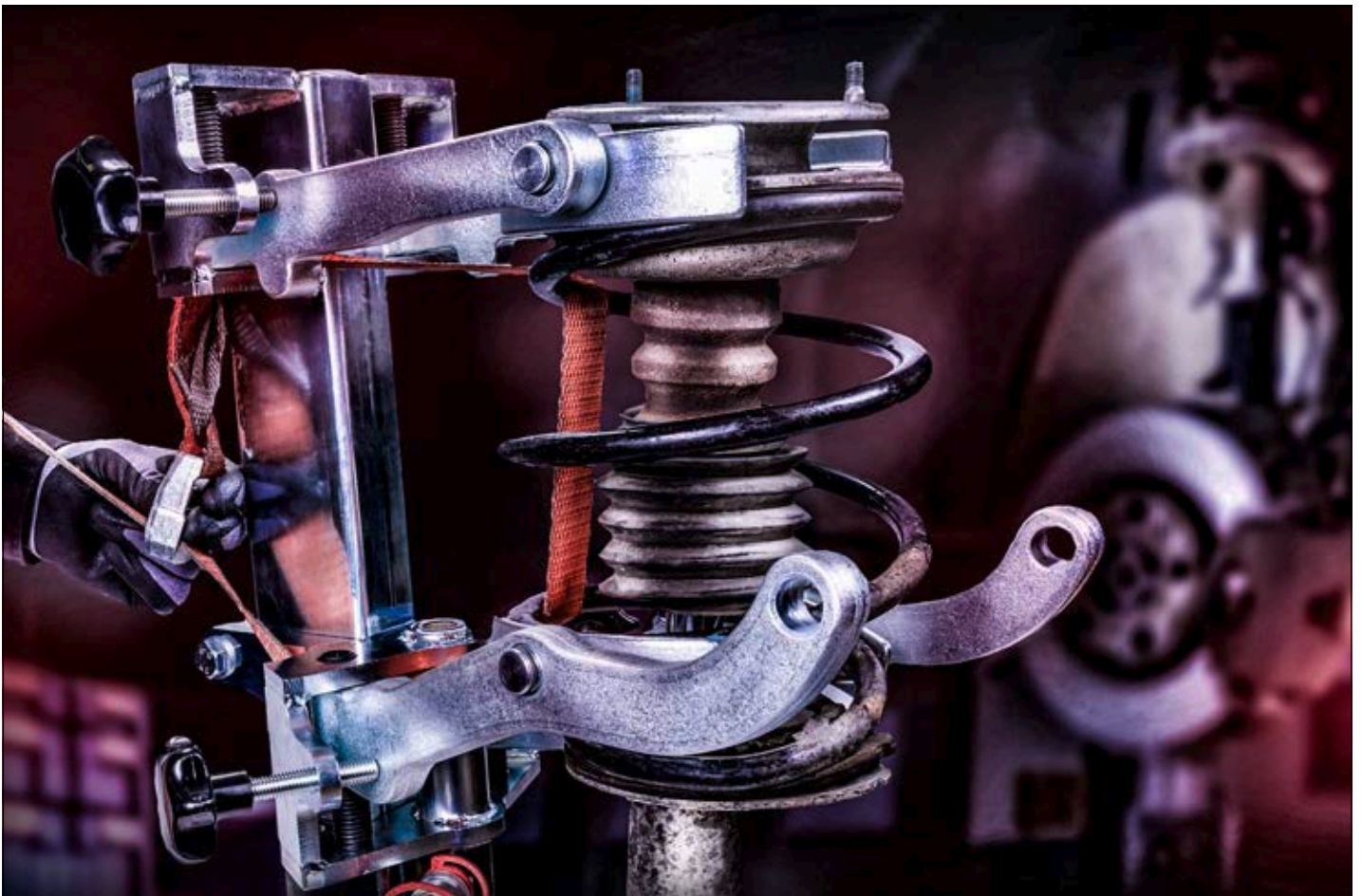

# Neuheiten-Übersicht



**V7280**, EAN 4047728081955

**Mobile Werkbank mit Spezialwerkzeug Sortiment**

• Lieferung ohne Fahrgriff



388







## Werkstattwagen und Betriebseinrichtung

Werkstattwagen mit Sortiment	29–45
Mobile Werkbank mit Sortiment	46–47
Werkstattwagen ohne Sortiment	48–53, 56
Mobile Werkbank ohne Sortiment	54–55
Servicewagen	57
Zubehör für Werkstattwagen	58–65
Schrankwand-System	67–78
Zubehör Schrankwand-System	79–89

VIGOR Nr:		h x b x t mm	Gesamtragkraft kg	Arbeitsplatte	Einlagen- größe	Einlagenmaß mm	Anzahl Schubladen	Traglast pro Schublade kg	Schub- laden- auszug	Schubladen Verschluss
	 <b>V5489</b>	1000 x 677 x 459	400	Abnehmbare Schaum- stoffmatte	L	563 x 393	7	20	100%	Zentralver- riegelung
	 <b>V1901</b>	1000 x 723 x 459	500	Lösemittelbe- ständiger Kunststoff	L	563 x 393	7	25	100%	Zentralver- riegelung
	 <b>V4481</b>	1000 x 907 x 481	500	Lösemittelbe- ständiger Kunststoff	XL	750 x 393	8	25	100%	Zentralver- riegelung
	 <b>V4481-X</b>	1017 x 940 x 514	500	Edelstahl- Arbeitsplatte	XL	750 x 393	8	25	100%	Zentralver- riegelung
	 <b>V4481-XXL</b>	1017 x 1625 x 695	1000	Edelstahl- Arbeitsplatte	XD	790 x 570	13	30	100%	Zentralver- riegelung
	 <b>V4481-XD</b>	1017 x 986 x 695	500	Edelstahl- Arbeitsplatte	XD	790 x 570	8	30	100%	Zentralver- riegelung
	 <b>V4813</b>	1000 x 1091 x 481	1000	Holz-Arbeits- platte mit Auffangrille	L	563 x 393	8	40	100%	Zentralver- riegelung
	 <b>V4814</b>	1000 x 907 x 481	1000	Holz-Arbeits- platte mit Auffangrille	XL	750 x 393	4	40	100%	Zentralver- riegelung

# Werkstattwagen mit Sortiment



V2379N, EAN 4047728055444



Werkstattwagen mit Sortiment und Auflagematte



Schubladen  
Bestückungsvarianten:

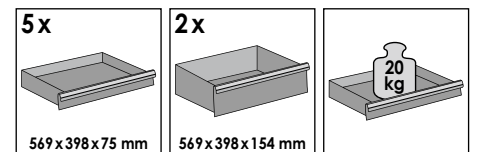
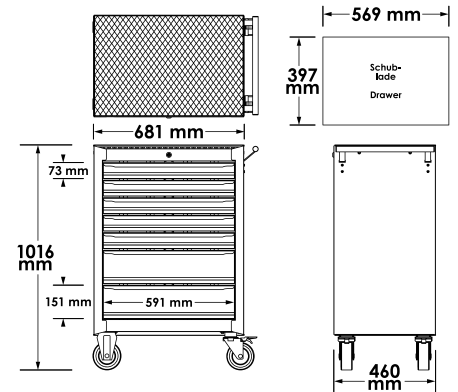

**769,- €**  
zzgl. MwSt.

## + Sortiment

V5116



V6726

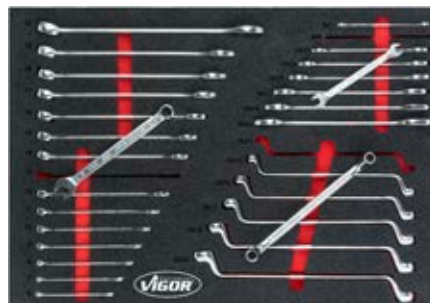

V5111N



V2712N, EAN 4047728055451

**VIGOR**  
SERIES **M**

Werkstattwagen mit Sortiment und Auflagematte



Schubladen  
Bestückungsvarianten:

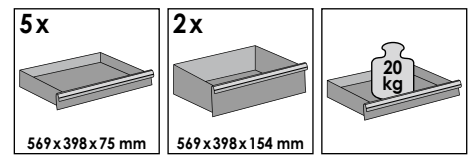
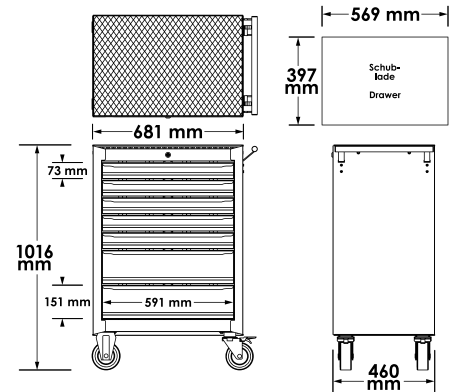

**953,- €**  
zzgl. MwSt.

**+ Sortiment**

V2837

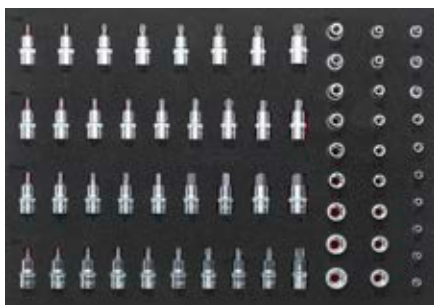

V6726

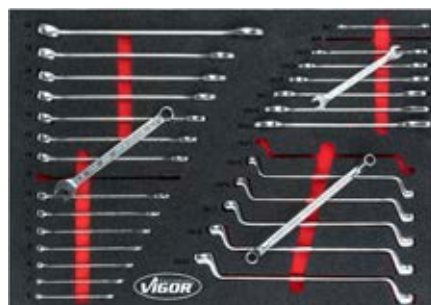

V5116



V5111N





# Werkstattwagen mit Sortiment



V4219, EAN 4047728042192



Werkstattwagen mit Sortiment und Kunststoff-Arbeitsplatte

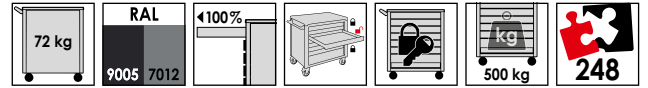

Schubladen  
Bestückungsvarianten:

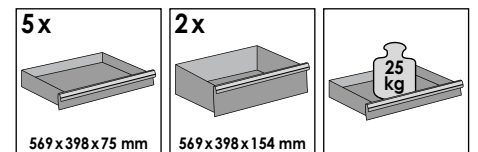
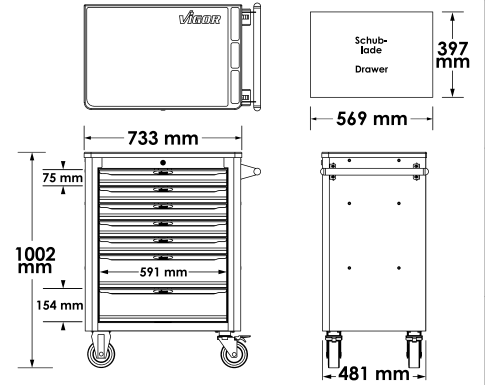

**1.466,50 €**  
zzgl. MwSt.

## + Sortiment

V6643



V4188



V5634N



V1901/376, EAN 4047728080293

**VIGOR**  
SERIES **L**

Werkstattwagen mit Sortiment  
und Kunststoff-Arbeitsplatte

**NEU**

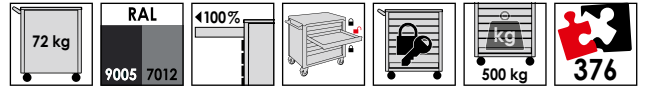

Schubladen  
Bestückungsvarianten:

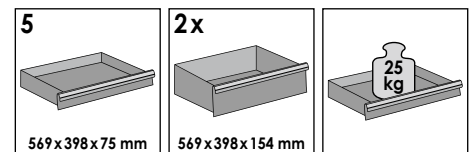
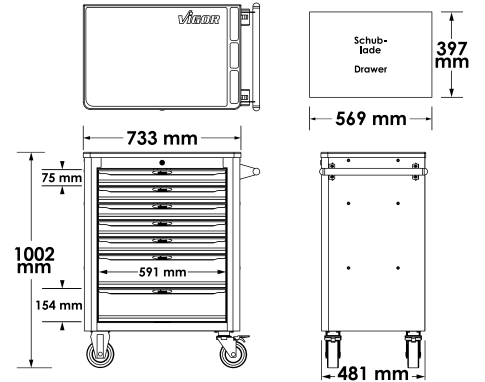

**1.990,- €**  
zzgl. MwSt.



**+ Sortiment**

V4188



V4753

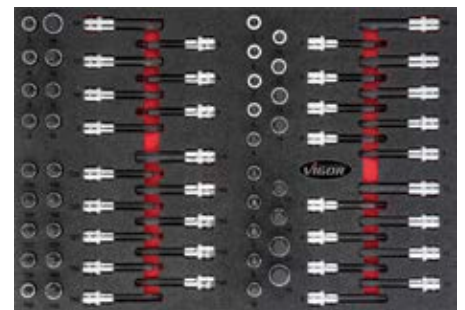

V6724



V5068



V5070

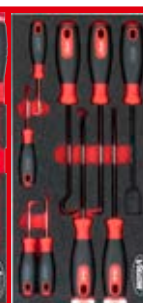

V5006



V5633N



V5603



V7324



# Werkstattwagen mit Sortiment



V5055, EAN 4047728050562



Werkstattwagen mit Sortiment  
und Kunststoff-Arbeitsplatte

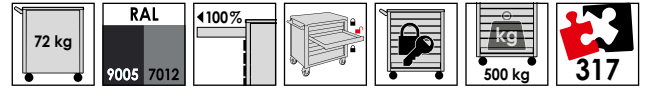

Schubladen  
Bestückungsvarianten:

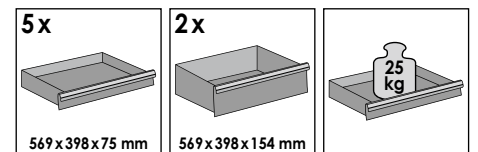
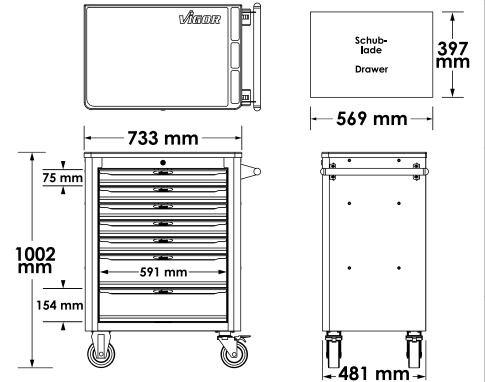

**1.710,50 €**  
zzgl. MwSt.

+ Sortiment

V4753

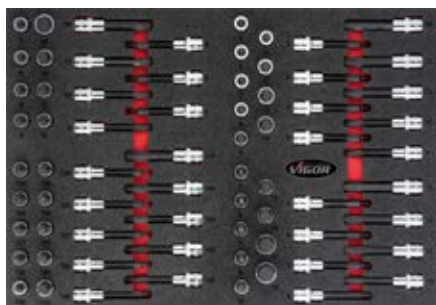

V6643



V4188



V5634N



V4560, EAN 4047728045605

**VIGOR**  
SERIES **L**

Werkstattwagen mit Sortiment und Kunststoff-Arbeitsplatte

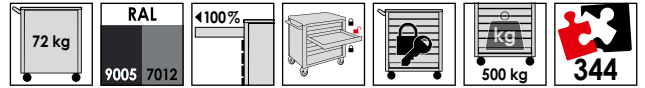

Schubladen  
Bestückungsvarianten:

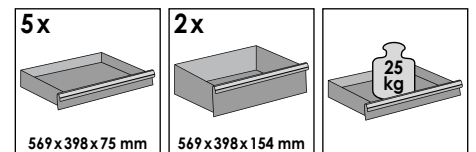
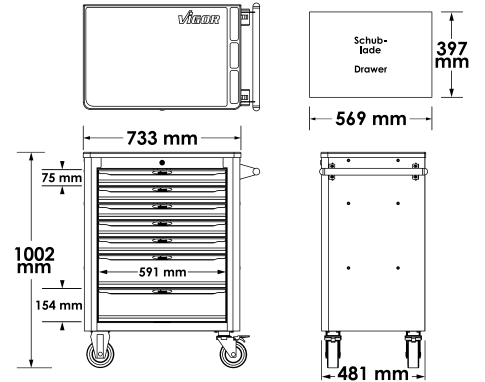

**1.833,- €**  
zzgl. MwSt.



+ Sortiment

V4188



V2837

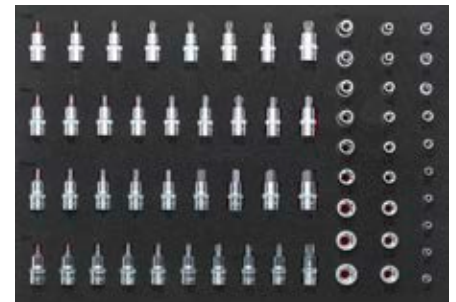

V4230



V5637N



V6643



# Werkstattwagen mit Sortiment



V4561, EAN 4047728045810



Werkstattwagen mit Sortiment und Aufsatzkoffer mit Kunststoff-Arbeitsplatte

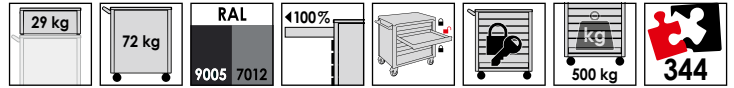

Schubladen  
Bestückungsvarianten:

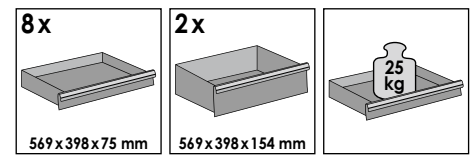
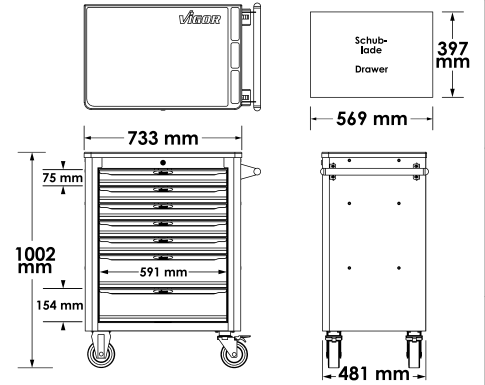

**2.199,- €**  
zzgl. MwSt.

**+ Sortiment**

V4188



V2837



V4230



V6643



V5637N



V4542, EAN 4047728045421

**VIGOR**  
SERIES **XL**

Werkstattwagen mit Sortiment und Kunststoff-Arbeitsplatte

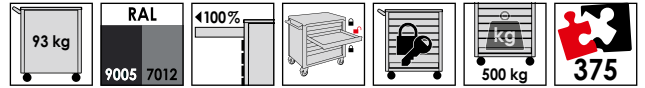

Schubladen Bestückungsvarianten:

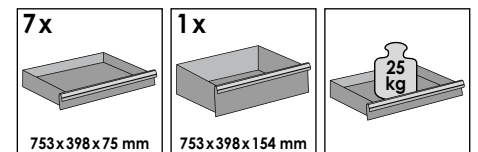
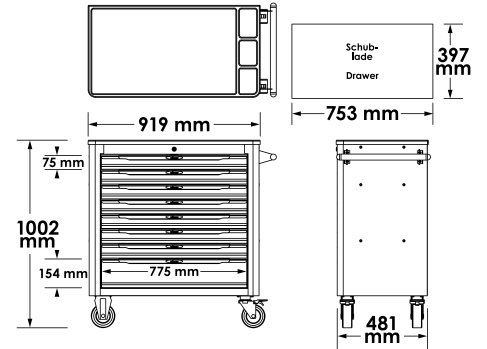

**2.321,50 €**  
zzgl. MwSt.

**+ Sortiment**

V4586



V6650



V5170



V5638N



# Werkstattwagen mit Sortiment



V5434, EAN 4047728054348



Werkstattwagen mit Sortiment und Kunststoff-Arbeitsplatte

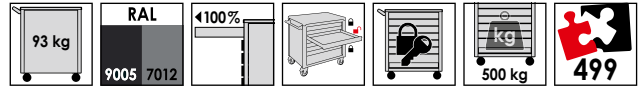

Schubladen Bestückungsvarianten:

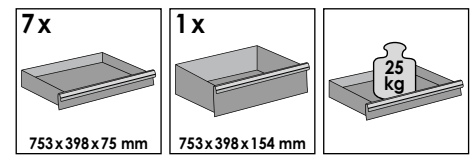
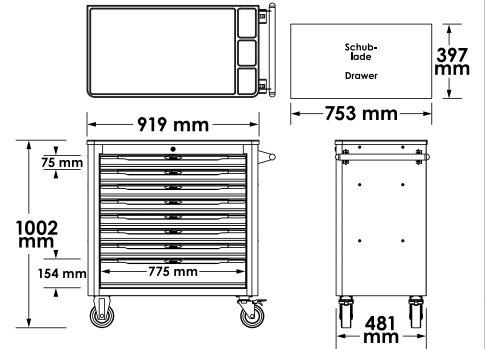

**3.055,- €** zzgl. MwSt.

**+ Sortiment**

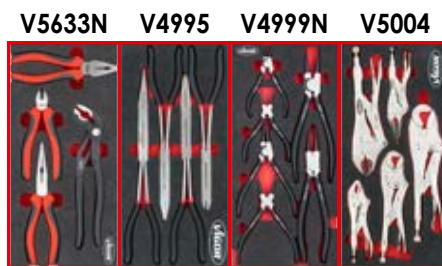
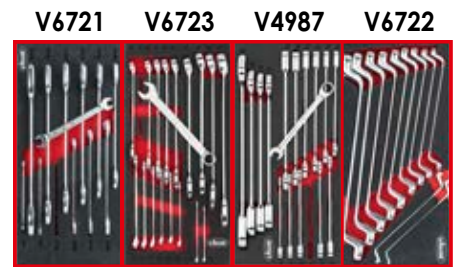
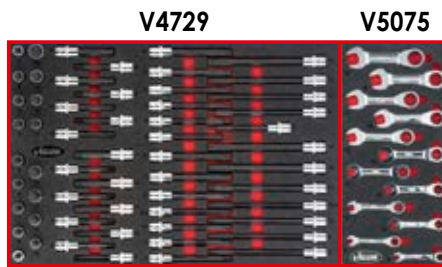
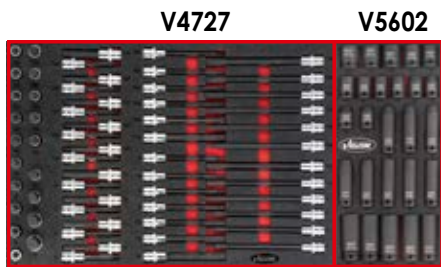
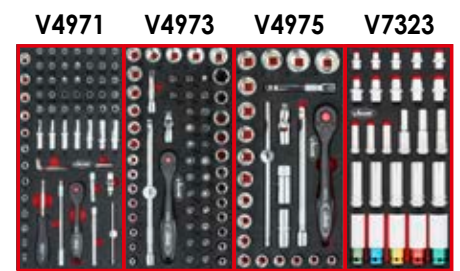

V4481-X/375, EAN 4047728062350

**VIGOR**  
SERIES **XL**

Werkstattwagen mit Sortiment und Edelstahl-Arbeitsplatte

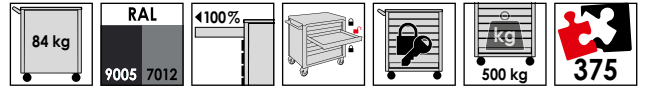

Schubladen Bestückungsvarianten:

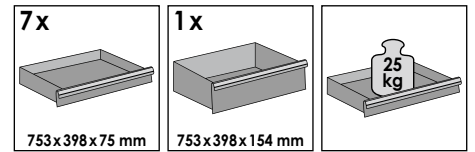
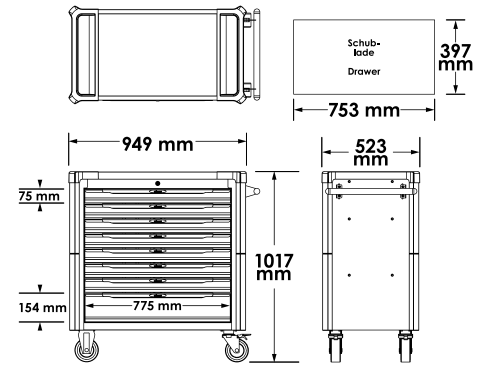

**2.444,- €**  
zzgl. MwSt.

**+ Sortiment**

V4586



V6650



V5170



V5638N





# Werkstattwagen mit Sortiment



V4481-X/466, EAN 4047728074674



Werkstattwagen mit Sortiment und Edelstahl-Arbeitsplatte

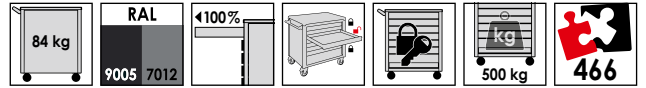

V2393-S

Schubladen Bestückungsvarianten:

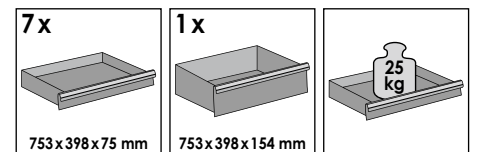
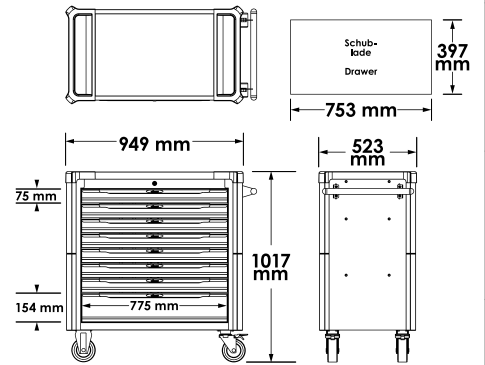

**2.749,- €** zzgl. MwSt.

V6394



V4586

**+ Sortiment**

V5170



V6015

V6650

V7015N



V4481-X/499, EAN 4047728062367

**VIGOR**  
SERIES **XL**

Werkstattwagen mit Sortiment und Edelstahl-Arbeitsplatte

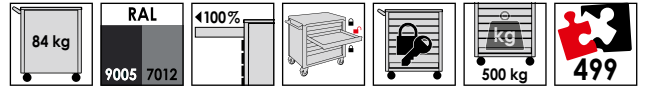

Schubladen Bestückungsvarianten:

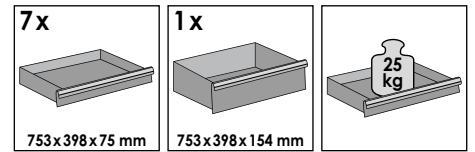
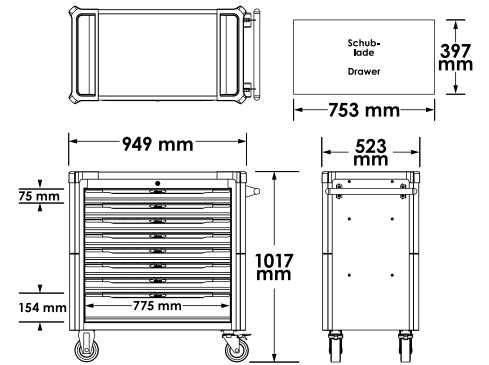

**3.177,50 €**  
zzgl. MwSt.

**+ Sortiment**

V4971 V4973 V4975 V7323



V4727

V5602



V4729

V5075



V6721

V6723

V4987

V6722

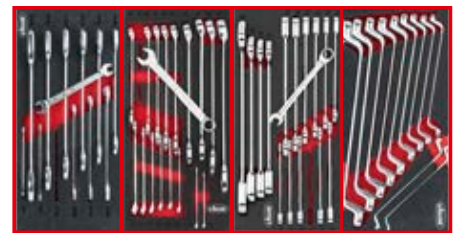

V5170

V5633N

V4995

V4999N

V5004

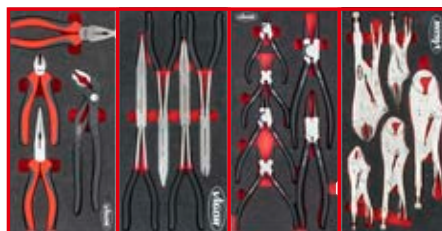

V5006

V5017

V5070

V5072





V4481-XD/469, EAN 4047728068512

**VIGOR**  
SERIES **XD**

Extratiefer Werkstattwagen mit Sortiment und Edelstahl-Arbeitsplatte

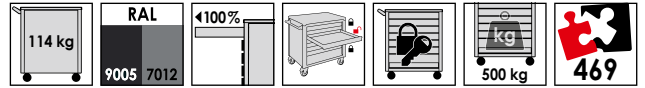

Schubladen  
Bestückungsvarianten:

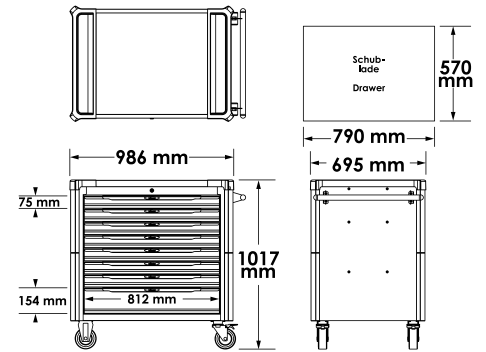

V4481 - EXTRA DEEP

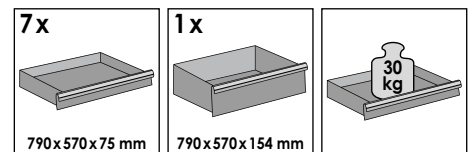

**+ Sortiment**

**3.362,50 €**  
zzgl. MwSt.

V6821



V6822N



V6807



V6808



V6813



V6814



V6815N

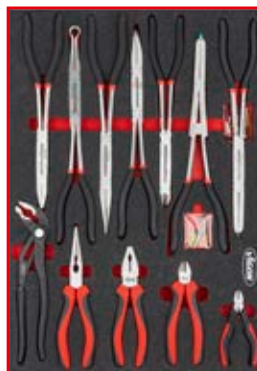

V6816

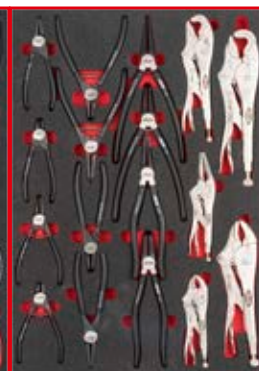

# Werkstattwagen mit Sortiment



V4481-XD/775, EAN 4047728068529



Extratiefer Werkstattwagen mit Sortiment und Edelstahl-Arbeitsplatte

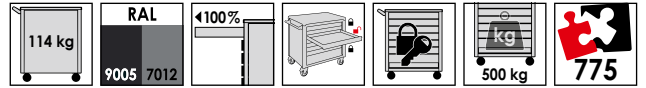

Schubladen  
Bestückungsvarianten:

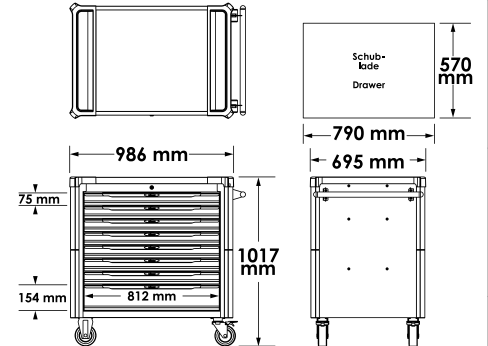

V4481 - EXTRA DEEP

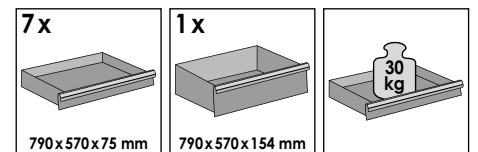

V6821 V6822



**5.377,50 €**  
zzgl. MwSt.

+ Sortiment

V6809

V6810

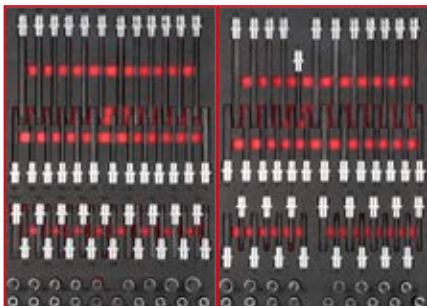

V6807

V6808

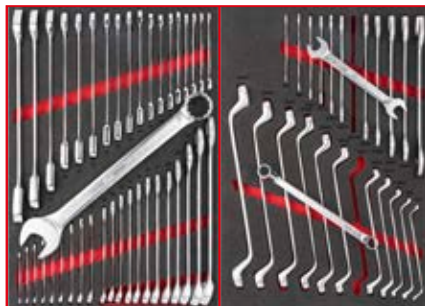

V6813

V6814



V6815

V6816N

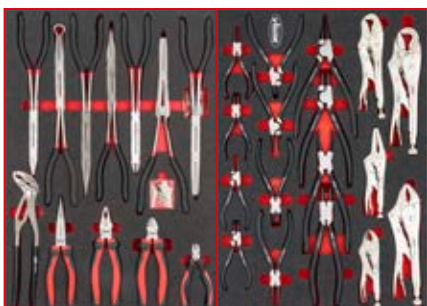

V6817

V6818

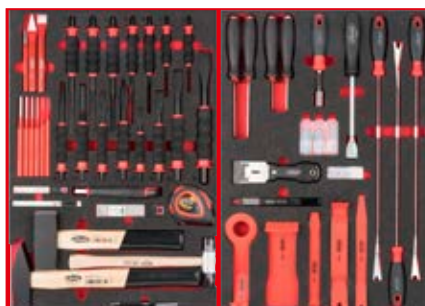

V6811

V6812

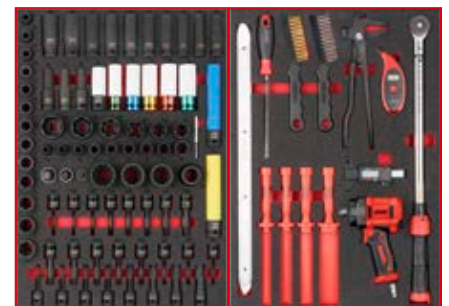

V4481-XXL/929, EAN 4047728082303

**VIGOR**  
SERIES **XXL**

Extratiefer, Extrabreiter Werkstattwagen mit Sortiment und Edelstahl-Arbeitsplatte

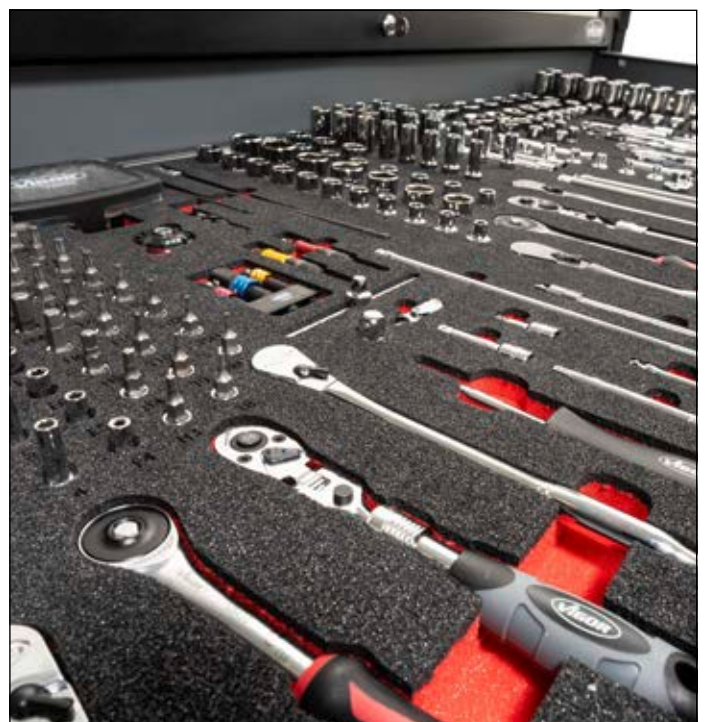

# Werkstattwagen mit Sortiment



**NEU**

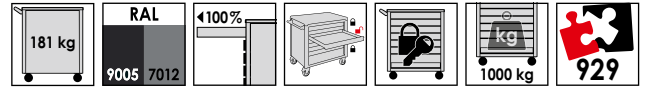

Schubladen  
Bestückungsvarianten:

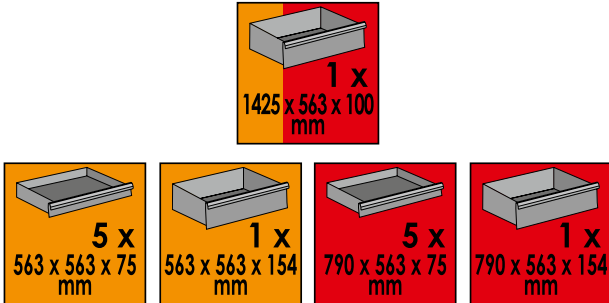
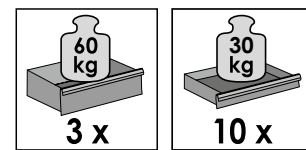
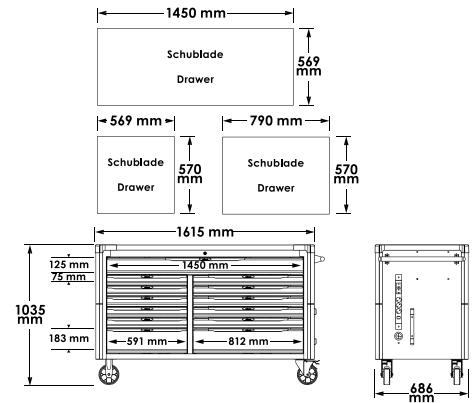

**+ Sortiment**

V6830

V6831

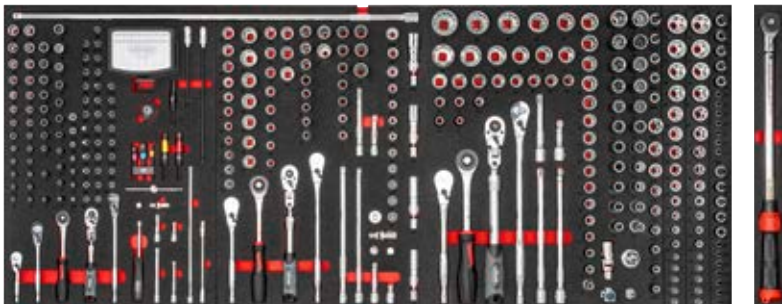

**7.499,- €**  
zzgl. MwSt.

V6807

V6808

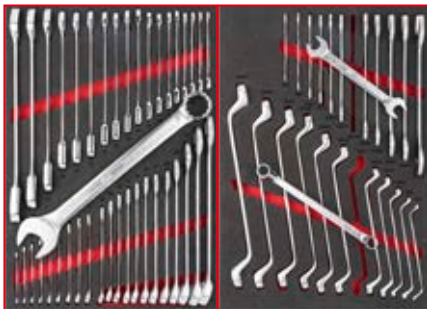

V6813

V6814



V2393-XD



V6809

V6810

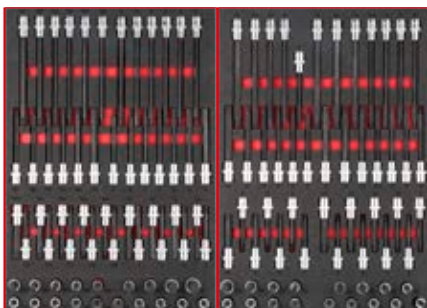

V6815

V6811



V6817

V6818

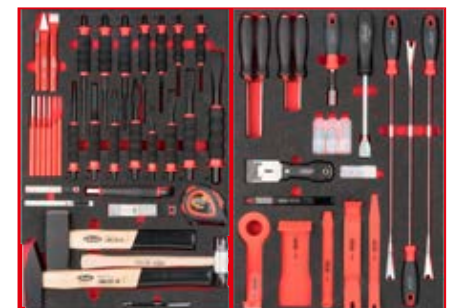

V5156, EAN 4047728051569

**VIGOR**  
SERIES **L**

Mobile Werkbank mit Sortiment und Holzplatte

• Lieferung ohne Fahrgriff

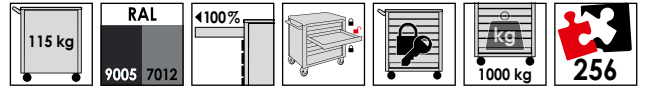

Schubladen  
Bestückungsvarianten:

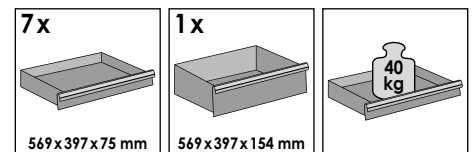
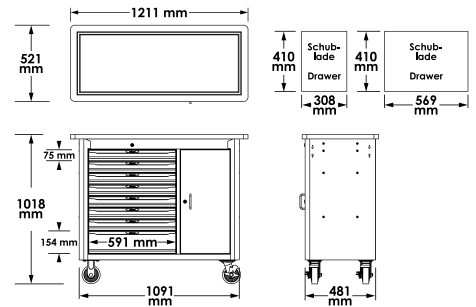

**2.321,50 €**  
zzgl. MwSt.



+ Sortiment

V4188



V6643



V4230



V5636N





# Mobile Werkbank mit Sortiment



V5158, EAN 4047728051583



Mobile Werkbank mit Sortiment und Holzplatte

• Lieferung ohne Fahrgriff

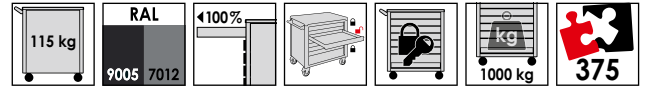

Schubladen  
Bestückungsvarianten:

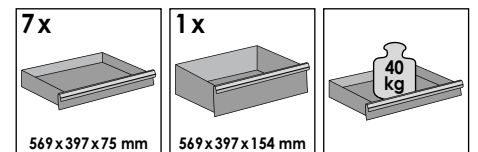
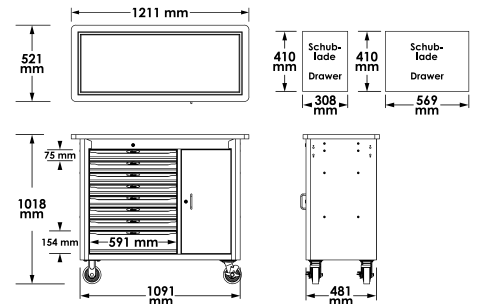

**2.629,- €**  
zzgl. MwSt.

**+ Sortiment**

V4188



V4727

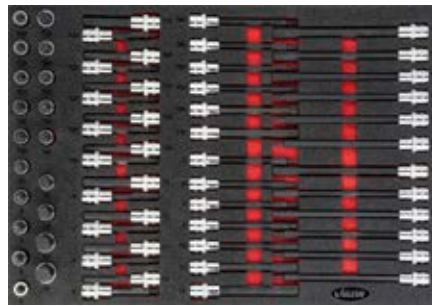

V4729

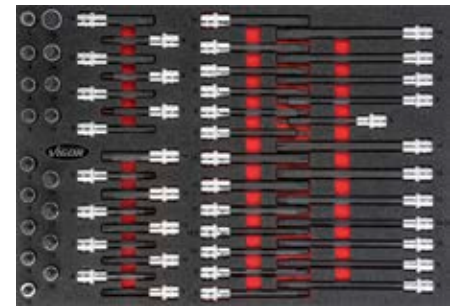

V6643



V4230



V5636N



V5489, EAN 4047728054898

**VIGOR**  
SERIES **M**

Werkstattwagen ohne Sortiment, mit Schaum-Auflagematte

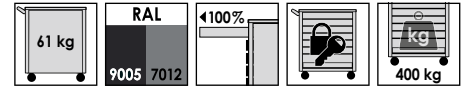

Schubladen  
Bestückungsvarianten:

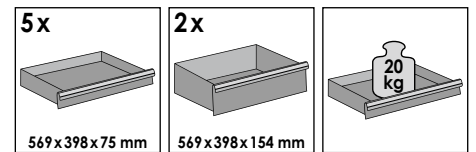
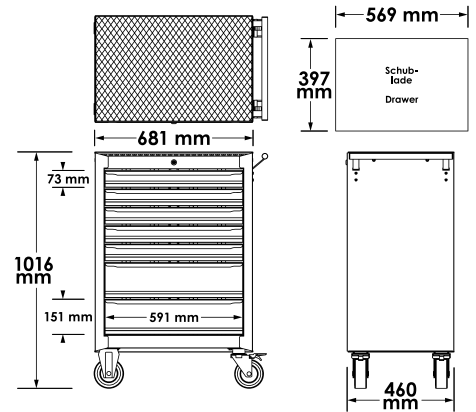

**746,- €**  
zzgl. MwSt.



# Werkstattwagen ohne Sortiment



V1901, EAN 4047728019019



Werkstattwagen ohne Sortiment, mit Kunststoff-Arbeitsplatte

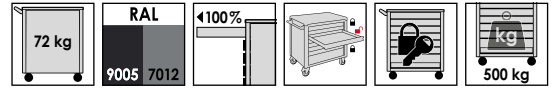

Schubladen  
Bestückungsvarianten:

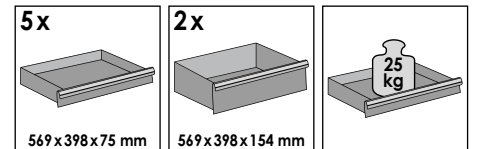
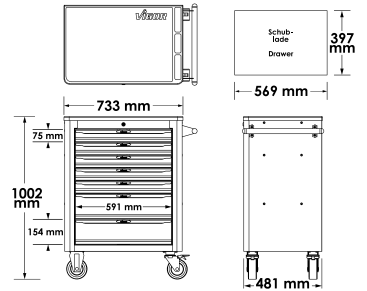

**1.122,- €**  
zzgl. MwSt.

V1902, EAN 4047728019026



Aufsatzkoffer für Werkstattwagen V1901

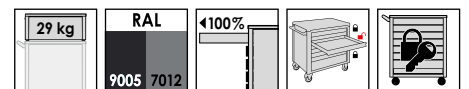

Schubladen  
Bestückungsvarianten:

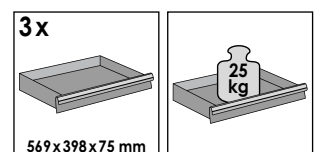
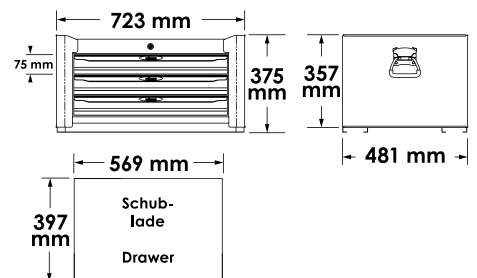

**567,- €**  
zzgl. MwSt.

- Lieferung ohne Kunststoffhaube,  
siehe V1909 -



V1970, EAN 4047728019705

**VIGOR**  
SERIES **L**

Werkstattwagen inklusive Aufsatzkoffer ohne Sortiment,  
mit Kunststoff-Arbeitsplatte

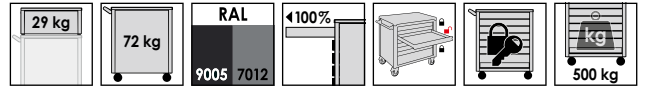

Schubladen  
Bestückungsvarianten:

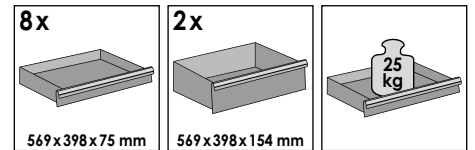
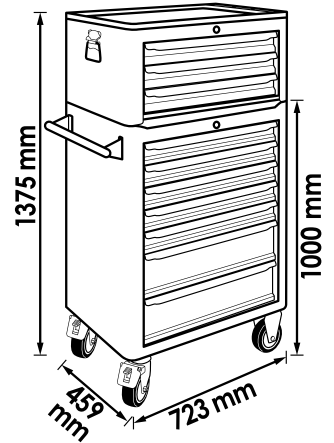

**1.634,- €**  
zzgl. MwSt.



# Werkstattwagen ohne Sortiment



V4481, EAN 4047728044813



Werkstattwagen ohne Sortiment, mit Kunststoff-Arbeitsplatte

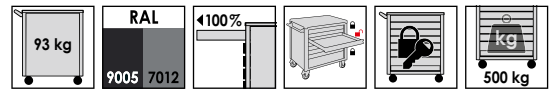

Schubladen Bestückungsvarianten:

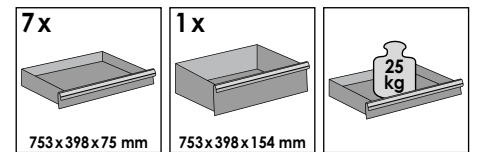
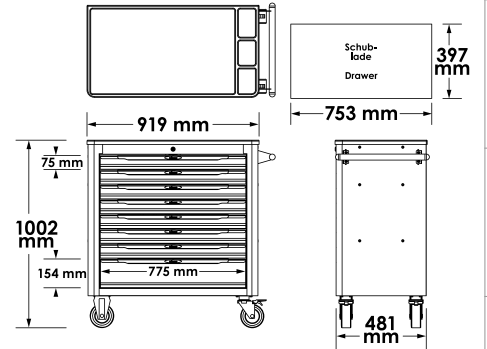

**1.349,50 €** zzgl. MwSt.



V4481-X, EAN 4047728060721

**VIGOR**  
SERIES **XL**

Werkstattwagen ohne Sortiment, mit Edelstahl-Arbeitsplatte

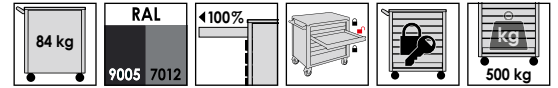

Schubladen Bestückungsvarianten:

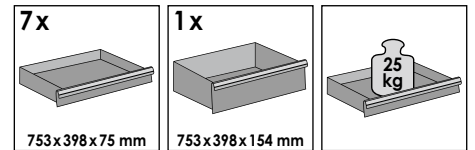
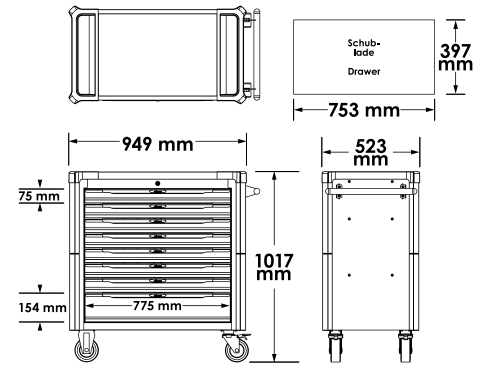

**1.490,50 €**  
zzgl. MwSt.



# Werkstattwagen ohne Sortiment



V4481-XD, EAN 4047728066488



Extratiefer Werkstattwagen ohne Sortiment, mit Edelstahl-Arbeitsplatte



V4481 - EXTRA DEEP

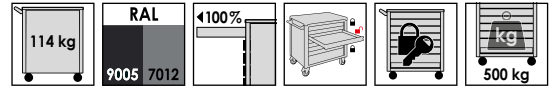

Schubladen  
Bestückungsvarianten:

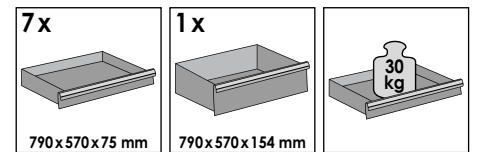
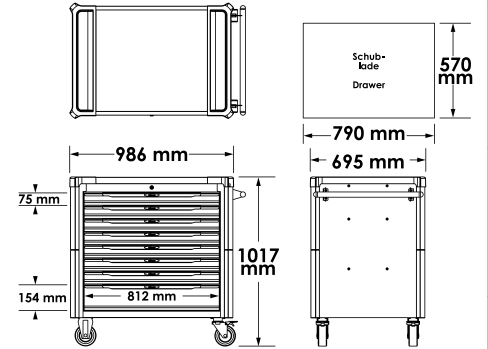

**1.519,50 €** zzgl. MwSt.

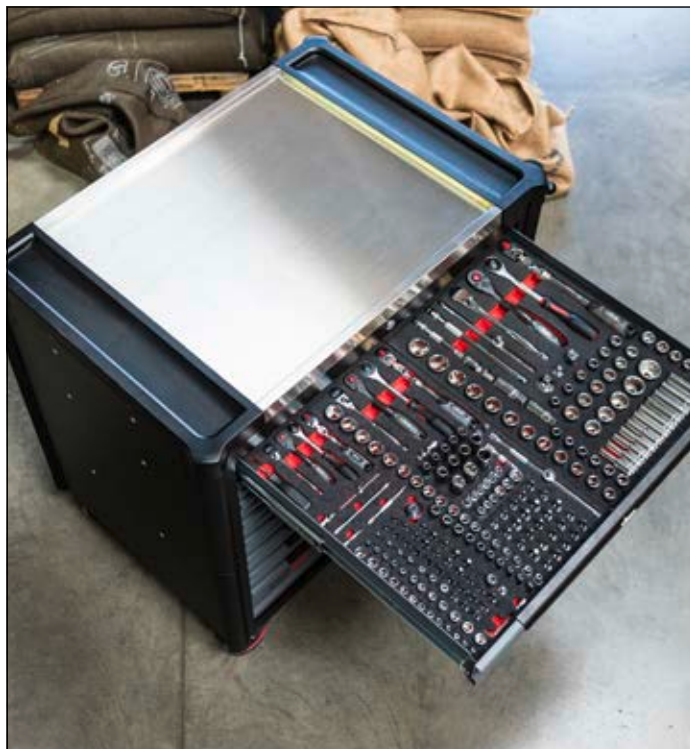

V4813, EAN 4047728048132

**VIGOR**  
SERIES **L**

Mobile Werkbank ohne Sortiment, mit Holzplatte

• Lieferung ohne Fahrgriff

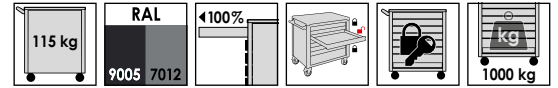

Schubladen  
Bestückungsvarianten:

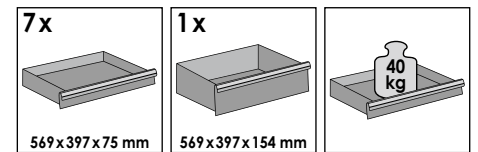
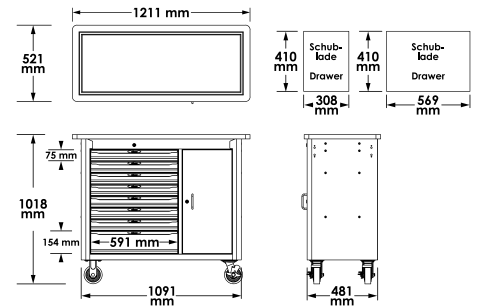

**1.810,50 €**  
zzgl. MwSt.





# Mobile Werkbank ohne Sortiment



V4814, EAN 4047728048149



Mobile Werkbank ohne Sortiment, mit Holzplatte

• Lieferung ohne Fahrgriff

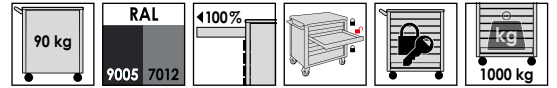

Schubladen Bestückungsvarianten:

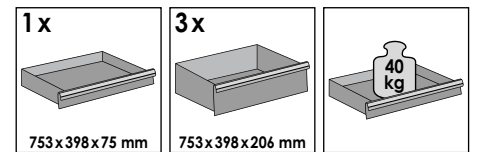
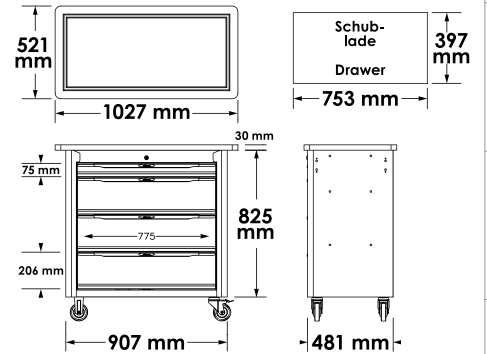

**1.735,50 €** zgl. MwSt.



V4481-XXL, EAN 4047728080491

**VIGOR SERIES XXL**

Extratiefer, Extrabreiter Werkstattwagen ohne Sortiment, mit Edelstahl-Arbeitsplatte

**NEU**

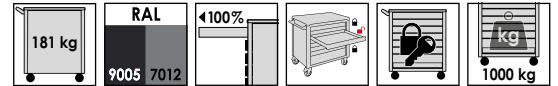

Schubladen Bestückungsvarianten:

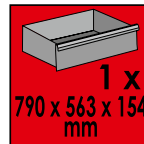
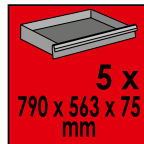
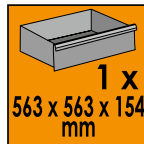
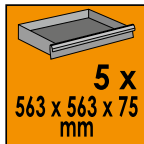
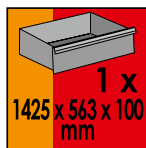
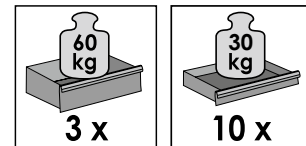
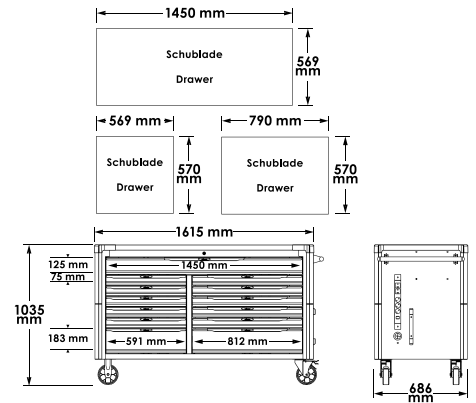

**2.999,- €** zzgl. MwSt.



**V4758**, EAN 4047728**047586**

## Servicewagen

- Stabile Stahlblech-Konstruktion (1 mm starke Zwischenbleche und 1,5 mm starke Winkelemente)
- Mittlere Ebene in 7 Stufen um 30 mm höhenverstellbar, für z.B. Kanister
- Tragkraft pro Boden: 40 kg
- Große kugelgelagerte Räder (Ø 100 mm), 2 Lenkrollen, 2 Bockrollen
- Einfaches Bewegen auch bei hoher dynamischer Last
- Stabiler, fest am Korpus montierter Fahrgriff
- Gewicht: 19 kg

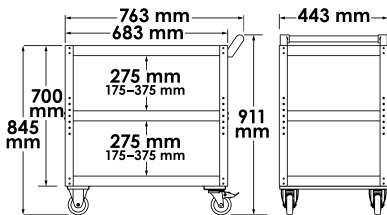

VIGOR No.	Bezeichnung		EAN 4047728+	€
<b>V5180</b>	Lenkrolle (Paar) · für Servicewagen V4758	2	051804	18,65
<b>V5191</b>	Bockrolle (Paar) · für Servicewagen V4758	2	051910	12,85

**MADE IN GERMANY**



**298,50 €**  
zzgl. MwSt.

**V6398**, EAN 4047728**071314**

## Laptop-Halter · dreh- und schwenkbar

- Passend für alle Serien Bj. 07/2019→ (mit vier Gewindehülsen)
- Schwenk-, und arretierbar
- 360° drehbar
- Frontale und seitliche Abkantung schützt das Gerät vor Sturz
- Ablagefläche lässt sich auf die gewünschte Neigung einstellen
- Vier Zusatzlochungen zum Durchführen von Kabeln

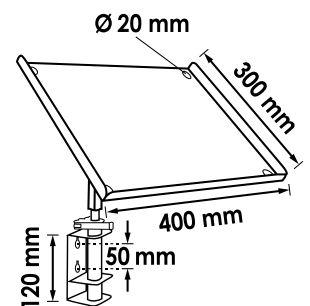

**85,45 €**  
zzgl. MwSt.



**V6221**, EAN 4047728062213

## Laptop-Tisch

- Zusätzliche Ablagefläche für Laptop, Tablets, Werkzeuge oder Kfz-Bauteile
- Passend für alle Serien
- Auf- und zuklappbar im montierten Zustand
- Erweiterung der Werkstattwagen-Oberfläche für mehr Ordnung und Übersicht beim Arbeiten
- Arretierung verhindert unbeabsichtigtes Einklappen des Tisches
- Maximal zugelassene Belastbarkeit: 25 kg



Verschraubte Arretierung

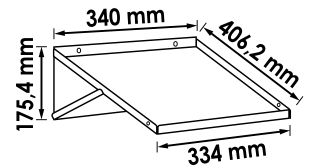

**75,80 €**  
zzgl. MwSt.

**V6395**, EAN 4047728070522

## Abfall-Behälter

- Entsorgung von Abfall oder Stofflappen
- Passend für alle Serien
- Auch zur Lagerung von Werkzeug geeignet
- Fassungsvermögen: 20 l

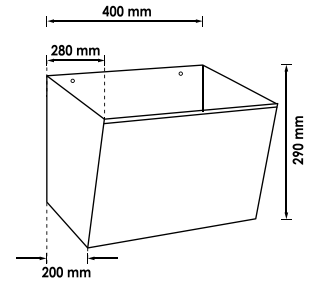

**85,45 €**  
zzgl. MwSt.

**V6396**, EAN 4047728069601

## Schraubendreher-Halter

- Schneller Zugriff auf Schraubendreher direkt am Werkstattwagen
- Passend für alle Serien
- Für 12 Schraubendreher

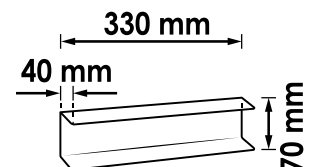

**20,70 €**  
zzgl. MwSt.

**V6394**, EAN 4047728069595

## Schlagschrauber-Halter

- Ablegen eines Schlagschraubers direkt am Werkstattwagen
- Passend für alle Serien Bj. 07/2019→ (mit vier Gewindehülsen)
- Kunststoff-Kantenschutz schützt vor Kratzern beim Einsetzen des Schlagschraubers
- Schlagschrauber geeignet

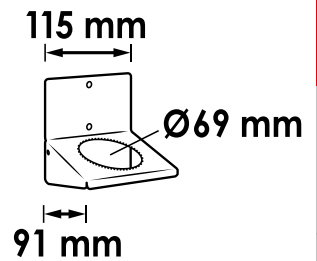

**24,35 €**  
zzgl. MwSt.

**V6689**, EAN 4047728079419

## Griffeiste für Werkstattwagen und VSS-Unterschränke

- Ersatz-Griffeiste mit Vigor Logo
- Passend an allen Series L, Series XL und Series XD Werkstattwagen sowie allen VSS-Unterschränken



**NEU**

**5,90 €**  
zzgl. MwSt.

**V2397**, EAN 4047728023979

## Papierrollen-Halter

- Aufhängen von Papierrollen direkt am Arbeitsplatz
- Passend für alle Serien
- Ohne Papierrolle
- Maximale Breite der Papierrolle: 370 mm

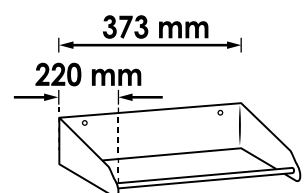
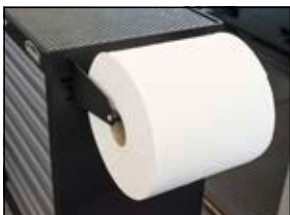

**37,90 €**  
zzgl. MwSt.

**V6397**, EAN 4047728069793

## Papierrollen-Halter · schwenkbar

- Aufhängen von Papierrollen direkt am Arbeitsplatz
- Passend für alle Serien
- Ohne Papierrolle
- Maximale Breite der Papierrolle: 320 mm

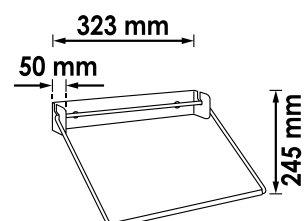

**32,90 €**  
zzgl. MwSt.



## Dokumentenhalter

- Ablegen von Klemmbrettern oder Auftragsaschen direkt am Arbeitsplatz
- Passend für alle Serien
- Optimale Unterbringung von Dokumenten oder Werkstattunterlagen direkt am Arbeitsplatz



VIGOR No.	Bezeichnung	Länge x Breite x Höhe mm	EAN 4047728+	€
V6393-S	Dokumenten-Halter · klein · Bodentiefe 43 mm	340x70x156	069205	45,15
V6393	Dokumenten-Halter · groß · Bodentiefe 100 mm	340x146x176	069519	52,45

## Dosenhalter

(ohne Dosen)



VIGOR No.	Bezeichnung	EAN 4047728+	€
V2393	Dosenhalter · für Series M · Series L · Series XL · Series XD (ausgenommen V4481-X) · bis zu 5 Dosen	023931	34,80
V2393-S	Dosenhalter · kurz · für alle Serien · bis zu 4 Dosen	062046	36,60
V2393-XD	Dosenhalter · extra lang · für Series XD · bis zu 6 Dosen	067614	48,80

## Kleinteilefach



VIGOR No.	Bezeichnung	EAN 4047728+	€
V4481-X-4	Kleinteilefach · V4481-X	073639	21,50
V4481-XD-4	Kleinteilefach · V4481-XD	073646	26,90



## Trennblech Satz

- Sortierung von Kleinteilen in Werkstattwagen oder Schrankwand-Unterschrank
- Alle vier Einteilblech-Größen kompatibel mit dem Trennblech Satz
- Einteilbleche ineinander einsetzbar dank asymmetrischer Stanzung
- Feuerverzinkte Oberfläche verhindert Rostbildung

MADE IN GERMANY

XD

XL

L

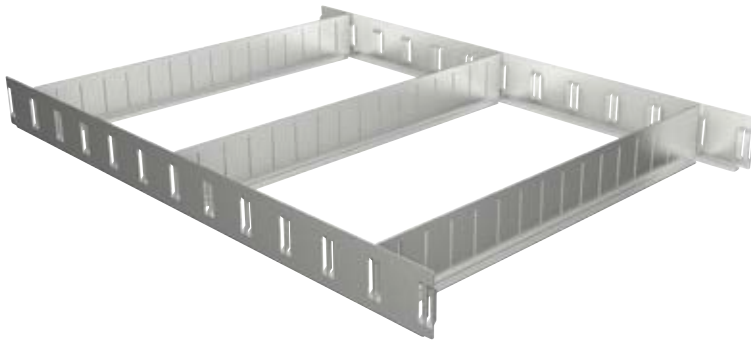

192 Einteilungen möglich



VIGOR No.	Bezeichnung	XX	EAN 4047728+	€
V6688	Trennblech Satz Series M und Series L	5	070249	28,75
V6688-XL	Trennblech Satz Series XL	6	070096	36,60
V6688-XD	Trennblech Satz Series XD	6	070089	39,75
V6688H	Trennblech Satz Hoch Series M und Series L	5	080958	36,-
V6688H-XD	Trennblech Satz Hoch Series XD	5	081009	53,-
V6688H-XL	Trennblech Satz Hoch Series XL	5	081580	46,-

## Einteilblech Satz

- Kompatibel mit allen Trennblech Sätzen und Querträgern
- Zur Einteilung innerhalb einer Spalte

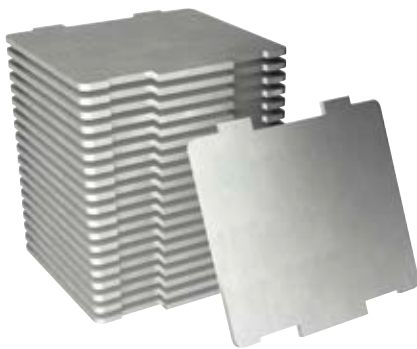

4 verschiedene Einteilblech-Längen – für alle Systeme verwendbar

MADE IN GERMANY

VIGOR No.	Bezeichnung	XX	EAN 4047728+	€
V6685-1/20	Einteilblech Satz · klein 45 mm	20	070133	28,05
V6685-2/20	Einteilblech Satz · mittel 91 mm	20	070126	36,60
V6685-3/10	Einteilblech Satz · groß 137 mm	10	070119	24,35
V6685-4/10	Einteilblech Satz · extragroß 183 mm	10	070102	29,95
V6685H-2/20	Einteilblech Satz Hoch · mittel 91 mm	20	080989	40,-
V6685H-3/10	Einteilblech Satz Hoch · groß 137 mm	10	081511	29,-
V6685H-4/10	Einteilblech Satz Hoch · extragroß 183 mm	10	080996	35,-

## Querträger Satz

- Feuerverzinkte Oberfläche verhindert Rostbildung



Dank Abkantung mehr Stabilität und Halt

MADE IN GERMANY



VIGOR No.	Bezeichnung	XX	EAN 4047728+	€
V6687/5	Querträger Satz für Series XD	5	070072	32,45
V6686/5	Querträger Satz für Series M · Series L und Series XL	5	070065	29,95
V6685H/5	Querträger Satz Hoch für Series M · Series L und Series XL	5	080972	40,-
V6687H/5	Querträger Satz für Series XD	5	080965	45,-



## Bockrolle



VIGOR No.	Bezeichnung		EAN 4047728+	€
V1907	Bockrolle · für Werkstattwagen Series M · Series L · Series XL · Series XD	1	019071	30,30
V4814-3	Bockrolle (Paar) · für Werkstattwagen Series XL · Series XL Spezial und Werkbänke	2	053044	62,90
V5191	Bockrolle (Paar) · für Servicewagen V4758	2	051910	12,85

## Lenkrolle mit Feststellbremse



VIGOR No.	Bezeichnung		EAN 4047728+	€
V1908	Lenkrolle · für Werkstattwagen Series M · Series L · Series XL · Series XD	1	019088	38,45
V4814-2	Lenkrolle (Paar) · für Werkstattwagen Series XL · Series XL Spezial und Werkbänke	2	053037	78,05
V5180	Lenkrolle (Paar) · für Servicewagen V4758	2	051804	18,65

## Schublade · flach



VIGOR No.	Bezeichnung	Länge x Breite x Höhe mm	EAN 4047728+	€
V5489-4	Schublade · flach · 569 x 398 x 75 mm · für Series M	589 x 398 x 75	055413	59,85
V1905	Schublade · flach · 569 x 398 x 75 mm · für Series L · V1901 · V1902 · Werkbank V4813	589 x 398 x 75	019057	83,85
V4112	Schublade · flach · 753 x 398 x 75 mm · für Series XL · Series XL Spezial	753 x 398 x 75	041126	94,90
V4481-XD-2	Schublade · flach · für Series XD	790 x 570 x 75	067812	150,50

## Schublade · hoch



VIGOR No.	Bezeichnung	Länge x Breite x Höhe mm	EAN 4047728+	€
V5489-3	Schublade · hoch · 569 x 398 x 154 mm · für Series M	589 x 398 x 154	055307	71,85
V1906	Schublade · hoch · 569 x 398 x 154 mm · für Series L · V1901 · Werkbank V4813	569 x 398 x 154	019064	108,-
V4111	Schublade · hoch · 753 x 398 x 154 mm · für Series XL	753 x 398 x 154	041119	119,-
V4814-1	Schublade · hoch · 741 x 397 x 206 mm · für Series XL Spezial	741 x 397 x 206	053020	155,-
V4481-XD-3	Schublade · hoch · für Series XD	790 x 570 x 154	067829	179,-



## Verriegelungssystem



VIGOR No.	Bezeichnung	EAN 4047728+	€
V2462	Ersatzschloss für alle VIGOR Werkstattwagen und Werkbänke	024624	18,05
V1904	Verriegelungssystem für alle VIGOR Werkstattwagen und Werkbänke	019040	24,45

## Führungsschienen (Paar)



VIGOR No.	Bezeichnung	 XL	EAN 4047728+	€
V1903	Führungsschienen (Paar) · für Series L · Series XL	2	019033	24,45
V5489-1	Führungsschienen (Paar) · für Series M	2	055284	16,20
V4481-XD-1	Führungsschienen (Paar) · für Series XD	-	067805	35,90

## Arbeitsplatte · Kunststoff



VIGOR No.	Bezeichnung	EAN 4047728+	€
V1909	Arbeitsplatte 723 x 459 mm · Kunststoff · für Werkstattwagen und Aufsatzkoffer Series L	019095	52,40
V4122	Arbeitsplatte 907 x 481 mm · Kunststoff · für Werkstattwagen Series XL	041225	71,85

## Arbeitsplatte · Holz



VIGOR No.	Bezeichnung	EAN 4047728+	€
V4814-4	Arbeitsplatte 1030 x 520 mm · Holz · für mobile Werkbank Series XL	053051	191,-
V4813-1	Arbeitsplatte 1201 x 520 mm · Holz · für Werkstattwagen Series L	053013	191,-



**V5489-2**, EAN 4047728055291

## Schaum-Auflagematte

- Für Werkstattwagen Series M
- LxB: 670x450 mm

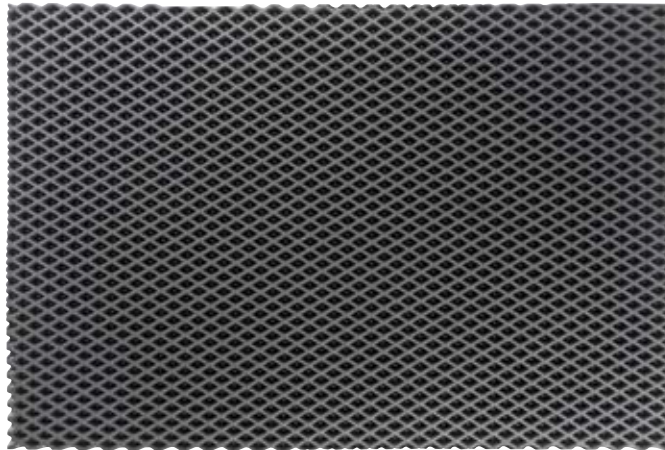

**12,25 €**  
zzgl. MwSt.

**V4813-2**, EAN 4047728059268

## Einlegeboden

- Für Werkbank VIGOR V4813
- LxB: 400x450 mm



**37,70 €**  
zzgl. MwSt.

**V5489-5**, EAN 4047728075626

## Fahrgriff

- Einfaches Rangieren von Werkstattwagen und Werkbänken
- Fahrgriff · für Werkstattwagen · Series M



**21,50 €**  
zzgl. MwSt.

**V4893**, EAN 4047728048934

## Fahrgriff

- Einfaches Rangieren von Werkstattwagen und Werkbänken
- Fahrgriff · für Werkstattwagen · Series L und Series XL



**27,05 €**  
zzgl. MwSt.

**V4481-X-5**, EAN 4047728075619

## Fahrgriff

- Einfaches Rangieren von Werkstattwagen
- Fahrgriff · für Werkstattwagen · Series XL · Edelstahl



**26,90 €**  
zzgl. MwSt.

**V4481-XD-5**, EAN 4047728075602

## Fahrgriff

- Einfaches Rangieren von Werkstattwagen
- Fahrgriff · für Werkstattwagen · Series XD







**29,70 €**  
zzgl. MwSt.



## Werkzeughaken Satz

- Aufhängung von Werkzeugen
- Verwendung mit Aufsatzschrank V2532 und Lochwandplatten V6000-05 · V6000-015
- Preis pro Satz

			
<b>V2517</b>	<b>V2518</b>	<b>V2519</b>	<b>V2520</b>
25 mm	100 mm	25 mm	100 mm
EAN 4047728+ 025171	EAN 4047728+ 025188	EAN 4047728+ 025195	EAN 4047728+ 025201
€ 25,45	€ 27,70	€ 28,80	€ 35,40

## V6150, EAN 4047728060691

### Schraubstock

- Drehteller
- Pulverbeschichtet
- Backenlänge 150 mm (6 Zoll)
- Gewindetiefe 68 mm
- Spannkraft 2,5 Tonnen
- $\approx$  13,5 kg

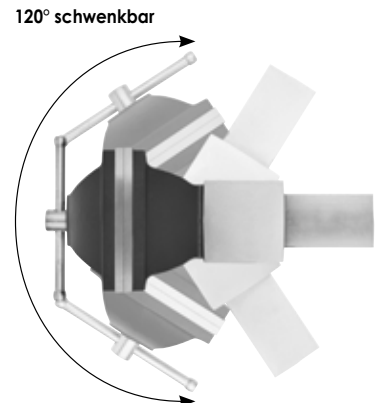
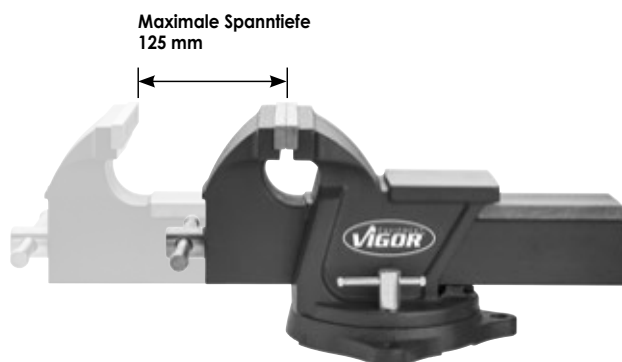
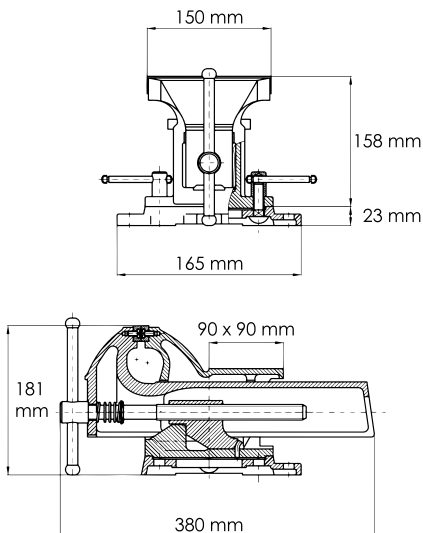

**153,50 €**  
zzgl. MwSt.



[www.vigor-equipment.com/konfigurator](http://www.vigor-equipment.com/konfigurator)

## KONVIGORATOR



### Technische Informationen



Einlagenmaß schmal  
563x393 mm



Füße bis 50 mm höhenverstellbar



Einlagenmaß breit  
750x393 mm



Befestigungsmaterial im  
Lieferumfang enthalten

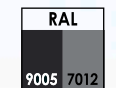

RAL Farben 9005 · ähnlich 7012



Zentralverriegelung

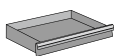

Schmale und flache Schublade  
Maße: 569x398x75 mm

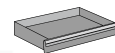

Breite und flache Schublade  
Maße: 753x398x75 mm

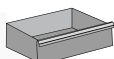

Schmale und hohe Schublade  
Maße: 569x398x154 mm



Breite und hohe Schublade  
Maße: 753x398x154 mm



Belastbarkeit Schublade: 25 kg

# Schrankwand-System



## V6000-3P1

### Schrankwand-System

- 3-Modul Kombination in breiter Ausführung
- Mit Holz- oder Edelstahl-Arbeitsplatte erhältlich
- Inklusive Seitenverblendung

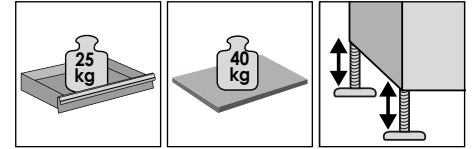
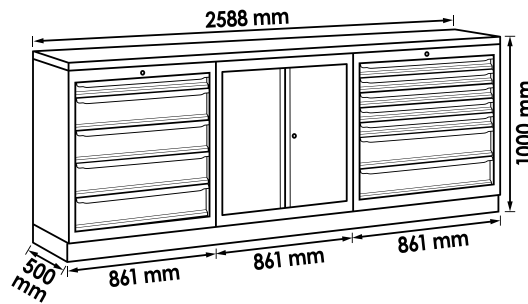

## Das Starter-Paket



VIGOR No.	Bezeichnung	Länge x Breite x Höhe mm	EAN 4047728+	€
V6000-3P1XL	Schrankwand-Kombination · Starter-Paket · Holz	2588 x 500 x 1000	073318	2.299,-
V6000-3P1XL-X	Schrankwand-Kombination · Starter-Paket · Edelstahl	2588 x 500 x 1000	073271	2.499,-

**Alle Pakete mit Edelstahl- oder Holz-Arbeitsplatten erhältlich**



## V6000-3P2

### Schrankwand-System

- 3-Modul Kombination in breiter Ausführung mit Lochwandaufbau und Hängeschränken
- Mit Holz- oder Edelstahl-Arbeitsplatte erhältlich
- Inklusive Seitenverblendung

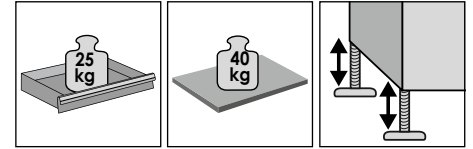
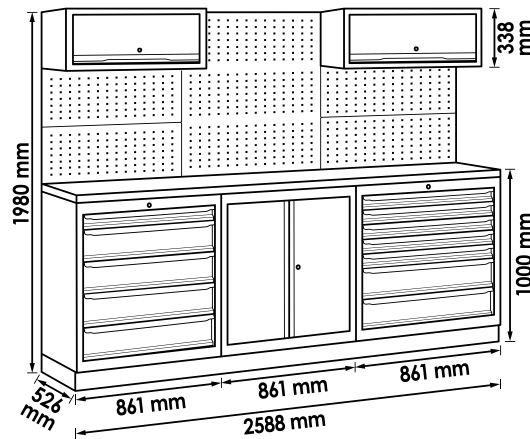

## Das Komplett-Paket



VIGOR No.	Bezeichnung	Länge x Breite x Höhe mm	EAN 4047728+	€
V6000-3P2XL	Schrankwand-Kombination · Komplett-Paket · Holz	2588 x 526 x 1980	073301	2.999,-
V6000-3P2XL-X	Schrankwand-Kombination · Komplett-Paket · Edelstahl	2588 x 526 x 1980	073295	3.200,-

## V6000-3

### Schrankwand-System

- Schranktür sowohl rechts als auch links montierbar
- Schranktür inklusive Magnet-Verschluss
- Höhenverstellbares Einlegefach
- Alle Türen in der Mitte verstärkt
- Gleichschließende Verriegelung (äquivalent zum Series L Schließsystem)
- Schubladen-Maße entsprechen Series L (569 x 398 x 75 mm flache Schublade, 569 x 398 x 154 mm hohe Schublade)
- Hängeschränke inklusive hochwertigen Dämpfern
- Lochwand für VIGOR Werkzeughaken-Sätze V2517 · V2518 · V2519 · V2520

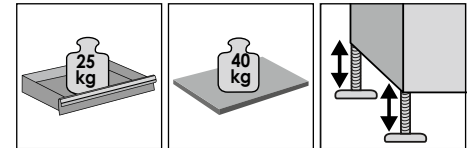
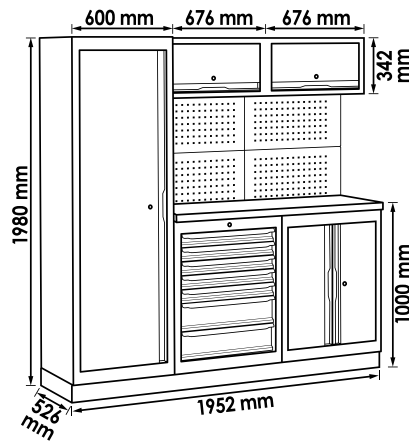

## Das Kompakt-Paket



VIGOR No.	Bezeichnung	EAN 4047728+	€
V6000-3	Schrankwand-Kombination · Kompakt-Paket · Holz	048729	2.499,-
V6000-3-X	Schrankwand-Kombination · Kompakt-Paket · Edelstahl	073288	2.599,-



**V6000-029**, EAN 4047728076975

## Schubladen-Unterschrank · 2 Schubladen

- Einrichtung eines stationären Arbeitsplatzes
- Saubere Aufbewahrung von Werkzeugkästen und Spezialwerkzeug-Koffern
- Gleicht Series L
- Schublade oben (HxBxT): 312x569x397 mm
- Schublade unten (HxBxT): 391x569x397 mm

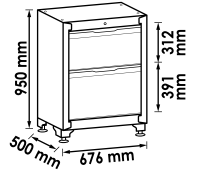
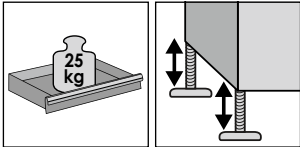

**701,- €**  
zzgl. MwSt.

**V6000-029XL**, EAN 4047728076982

## Schubladen-Unterschrank · 2 Schubladen

- Einrichtung eines stationären Arbeitsplatzes
- Saubere Aufbewahrung von Werkzeugkästen und Spezialwerkzeug-Koffern
- Gleicht Series XL
- Schublade oben (HxBxT): 312x753x397 mm
- Schublade unten (HxBxT): 391x753x397 mm

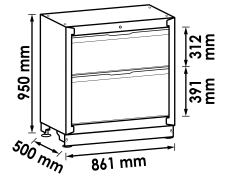
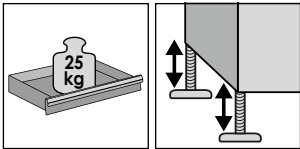

**759,50 €**  
zzgl. MwSt.

**V6000-030**, EAN 4047728070140

## Schubladen-Unterschrank · 3 Schubladen

- Einrichtung eines stationären Arbeitsplatzes
- Saubere Aufbewahrung von Werkzeugen, Kleinteilen oder diversen Verbrauchsmaterialien
- Für platzsparende und aufgeräumte Sortierung empfehlen wir VIGOR-Trennbleche oder Weichschaumeinlagen
- Gleicht Series L
- Maße (HxBxT)  
1. – 3. Schublade: 75x569x398 mm

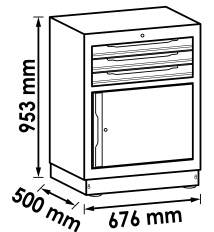
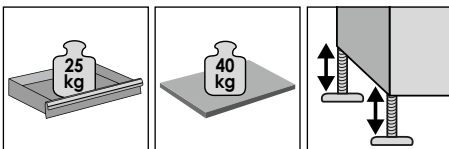

**571,- €**  
zzgl. MwSt.

**V6000-030XL**, EAN 4047728070294

## Schubladen-Unterschrank · 3 Schubladen

- Einrichtung eines stationären Arbeitsplatzes
- Saubere Aufbewahrung von Werkzeugen, Kleinteilen oder diversen Verbrauchsmaterialien
- Für platzsparende und aufgeräumte Sortierung empfehlen wir VIGOR-Trennbleche oder Weichschaumeinlagen
- Gleicht Series XL
- Maße (HxBxT)  
1. – 3. Schublade: 75x753x398 mm

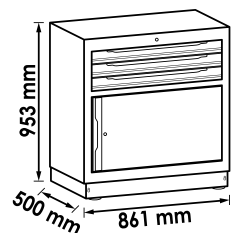
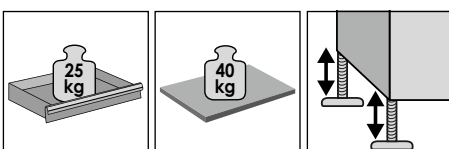

**680,- €**  
zzgl. MwSt.



**V6000-031**, EAN 4047728**070157**

## Schubladen-Unterschrank · 5 Schubladen

- Einrichtung eines stationären Arbeitsplatzes
- Saubere Aufbewahrung von Werkzeugen, Kleinteilen oder diversen Verbrauchsmaterialien
- Für platzsparende und aufgeräumte Sortierung empfehlen wir VIGOR-Trennbleche oder Weichschaumeinlagen
- Gleicht Series L
- Maße (HxBxT)
  1. Schublade: 75x569x398 mm
  2. – 5. Schublade: 154x569x398 mm

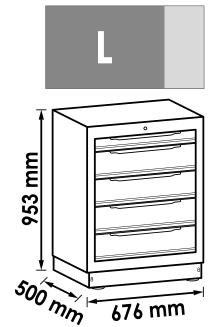
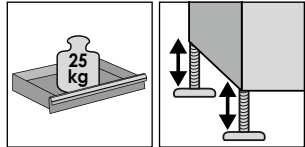

**666,- €**  
zzgl. MwSt.

**V6000-031XL**, EAN 4047728**070300**

## Schubladen-Unterschrank · 5 Schubladen

- Einrichtung eines stationären Arbeitsplatzes
- Saubere Aufbewahrung von Werkzeugen, Kleinteilen oder diversen Verbrauchsmaterialien
- Für platzsparende und aufgeräumte Sortierung empfehlen wir VIGOR-Trennbleche oder Weichschaumeinlagen
- Gleicht Series XL
- Maße (HxBxT)
  1. Schublade: 75x753x398 mm
  2. – 5. Schublade: 154x753x398 mm

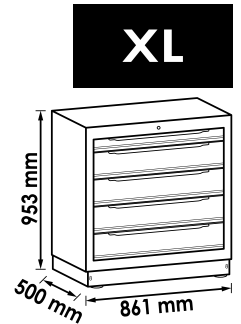
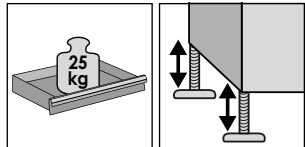

**783,50 €**  
zzgl. MwSt.

**V6000-031XD**, EAN 4047728**081184**

## Schubladen-Unterschrank · extra tief · 5 Schubladen

- Einrichtung eines stationären Arbeitsplatzes
- Saubere Aufbewahrung von Werkzeugen, Kleinteilen oder diversen Verbrauchsmaterialien
- Für platzsparende und aufgeräumte Sortierung empfehlen wir VIGOR-Trennbleche oder Weichschaumeinlagen
- Gleicht Series XD
- Maße (HxBxT)
  1. Schublade: 75x790x570 mm
  2. – 5. Schublade: 154x790x570 mm

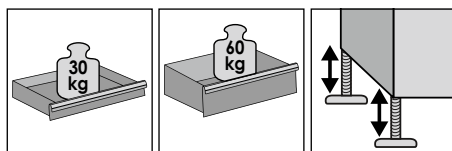

**NEU** XD

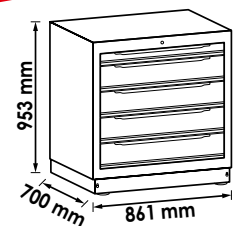

**1.150,- €**  
zzgl. MwSt.



**V6000-01**, EAN 4047728**048248**

## Schubladen-Unterschrank · 7 Schubladen

- Einrichtung eines stationären Arbeitsplatzes
- Saubere Aufbewahrung von Werkzeugen, Kleinteilen oder diversen Verbrauchsmaterialien
- Für platzsparende und aufgeräumte Sortierung empfehlen wir VIGOR-Trennbleche oder Weichschaumeinlagen
- Gleichl Series L
- Maße (HxBxT)
  1. – 5. Schublade: 75x569x398 mm
  6. – 7. Schublade: 154x569x398 mm

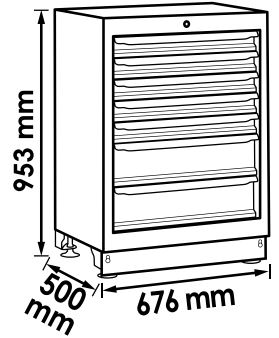
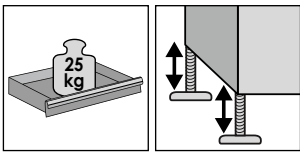

**701,50 €**  
zzgl. MwSt.

**V6000-01XL**, EAN 4047728**070317**

## Schubladen-Unterschrank · 7 Schubladen

- Einrichtung eines stationären Arbeitsplatzes
- Saubere Aufbewahrung von Werkzeugen, Kleinteilen oder diversen Verbrauchsmaterialien
- Für platzsparende und aufgeräumte Sortierung empfehlen wir VIGOR-Trennbleche oder Weichschaumeinlagen
- Gleichl Series XL
- Maße (HxBxT)
  1. – 5. Schublade: 75x753x398 mm
  6. – 7. Schublade: 154x753x398 mm

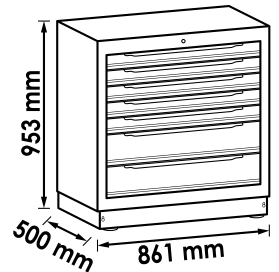
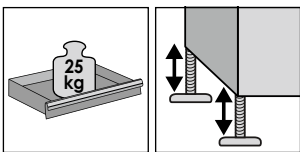

**816,- €**  
zzgl. MwSt.

**V6000-01XD**, EAN 4047728**081016**

## Schubladen-Unterschrank · extra tief · 7 Schubladen

- Einrichtung eines stationären Arbeitsplatzes
- Saubere Aufbewahrung von Werkzeugen, Kleinteilen oder diversen Verbrauchsmaterialien
- Für platzsparende und aufgeräumte Sortierung empfehlen wir VIGOR-Trennbleche oder Weichschaumeinlagen
- Gleichl Series XD
- Maße (HxBxT)
  1. – 5. Schublade: 75x790x570 mm
  6. – 7. Schublade: 154x790x570 mm

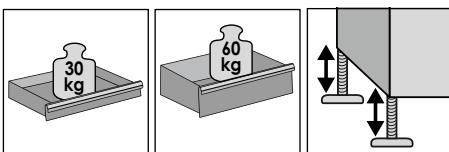

**NEU**

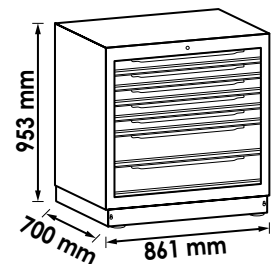

**1.260,- €**  
zzgl. MwSt.

**V6000-019**, EAN 4047728063883

## Werkstattwagen für Schrankwand-System · 7 Schubladen

- Platzsparende Aufbewahrung eines Werkstattwagens unter Schrankwand-Arbeitsplatte
- Speziell für VIGOR Schrankwand-System
- 4 Lenkrollen und Sonderhöhe für platzsparende Unterbringung des Werkstattwagens nach Gebrauch unter Schrankwand-Arbeitsplatte
- Gleicht Series L
- Maße (HxBxT)
  1. – 5. Schublade: 75x569x398 mm
  6. – 7. Schublade: 154x569x398 mm

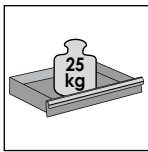

Mit 4 Lenkrollen

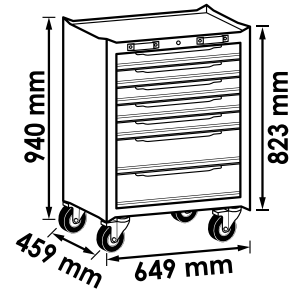

**748,50 €**  
zzgl. MwSt.

**V6000-019XL**, EAN 4047728070683

## Werkstattwagen für Schrankwand-System · 7 Schubladen

- Platzsparende Aufbewahrung eines Werkstattwagens unter Schrankwand-Arbeitsplatte
- Speziell für VIGOR Schrankwand-System
- 4 Lenkrollen und Sonderhöhe für platzsparende Unterbringung des Werkstattwagens nach Gebrauch unter Schrankwand-Arbeitsplatte
- Gleicht Series XL
- Maße (HxBxT)
  1. – 5. Schublade: 75x753x398 mm
  6. – 7. Schublade: 154x753x398 mm

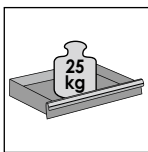

Mit 4 Lenkrollen

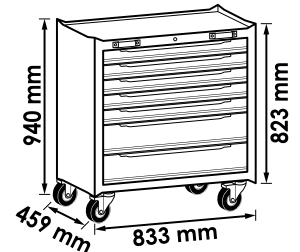

**802,50 €**  
zzgl. MwSt.

**V6000-032**, EAN 4047728070171

## Schubladen-Unterschrank · 8 Schubladen

- Einrichtung eines stationären Arbeitsplatzes
- Saubere Aufbewahrung von Werkzeugen, Kleinteilen oder diversen Verbrauchsmaterialien
- Für platzsparende und aufgeräumte Sortierung empfehlen wir VIGOR-Trennbleche oder Weichschaumeinlagen
- Gleicht Series L
- Maße (HxBxT)
  1. – 7. Schublade: 75x569x398 mm
  8. Schublade: 154x569x398 mm

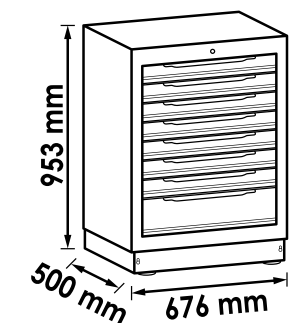
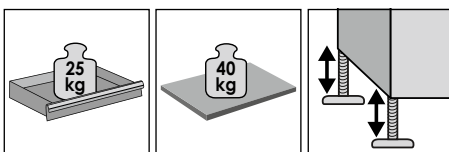

**748,50 €**  
zzgl. MwSt.



**V6000-032XL**, EAN 4047728070324

## Schubladen-Unterschrank · 8 Schubladen

- Einrichtung eines stationären Arbeitsplatzes
- Saubere Aufbewahrung von Werkzeugen, Kleinteilen oder diversen Verbrauchsmaterialien
- Für platzsparende und aufgeräumte Sortierung empfehlen wir VIGOR-Trennbleche oder Weichschaumeinlagen
- Gleicht Series XL
- Maße (HxBxT)  
1. – 7. Schublade: 75x753x398 mm  
8. Schublade: 154x753x398 mm

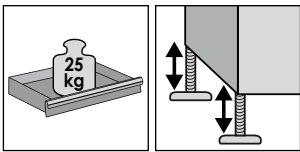

**XL**

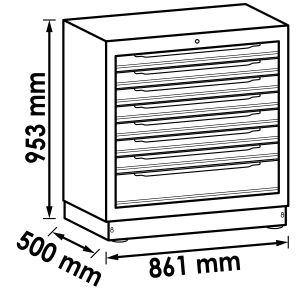

**865,- €**  
zzgl. MwSt.

**V6000-033**, EAN 4047728070195

## Abfall-Unterschrank

- Einrichtung eines stationären Arbeitsplatzes
- Mülltrennung direkt am Arbeitsplatz
- Abfallbehälter sicher und sauber im Schrankwandmodul platziert
- Unterschrank mit Durchwurflappe zur raschen Entsorgung von Abfall
- Lieferung inklusive zwei Abfallbehälter
- Fassungsvermögen Abfallbehälter: 35 l
- Gleicht Series L

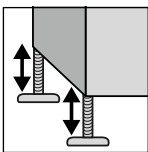

**L**

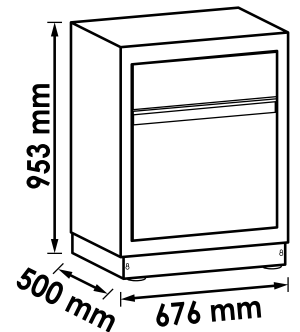

**571,- €**  
zzgl. MwSt.

**V6000-033XL**, EAN 4047728070331

## Abfall-Unterschrank

- Einrichtung eines stationären Arbeitsplatzes
- Mülltrennung direkt am Arbeitsplatz
- Abfallbehälter sicher und sauber im Schrankwandmodul platziert
- Unterschrank mit Durchwurflappe zur raschen Entsorgung von Abfall
- Lieferung inklusive drei Abfallbehälter
- Fassungsvermögen Abfallbehälter: 1 x 25 l · 2 x 35 l
- Gleicht Series L

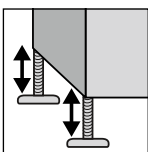

**XL**

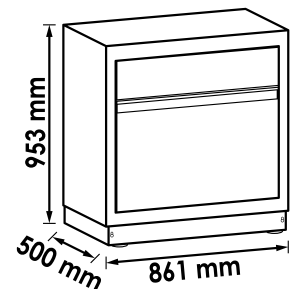

**639,- €**  
zzgl. MwSt.

**V6000-035**, EAN 4047728**074582**

## Multifunktions Unterschrank

- Einrichtung eines stationären Arbeitsplatzes
- Abfallbehälter (35 l) mit Durchwurfklappe zur raschen Müllentsorgung
- Papierrollen-Halterung
- Schublade (Traglast 25 kg) zum Verstauen von Werkzeugen, Kleinteilen oder diversen Verbrauchsmaterialien
- Schubladen-Maße:
  - Links: B 288 x T 397 x H 707 mm
  - Rechts: B 260 x T 397 x H 340 mm

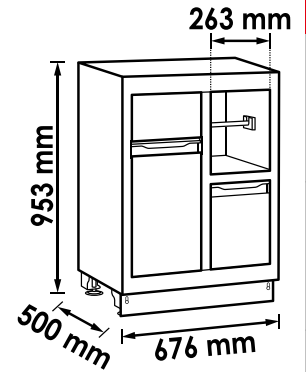
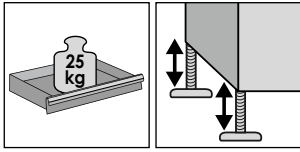

**786,- €**  
zzgl. MwSt.

**V6000-035XL**, EAN 4047728**074599**

## Multifunktions Unterschrank

- Einrichtung eines stationären Arbeitsplatzes
- Abfallbehälter (35 l) mit Durchwurfklappe zur raschen Müllentsorgung
- Papierrollen-Halterung
- Schublade (Traglast 25 kg) zum Verstauen von Werkzeugen, Kleinteilen oder diversen Verbrauchsmaterialien
- Schubladen-Maße:
  - Links: B 268 x T 397 x H 707 mm
  - Rechts: B 471 x T 397 x H 340 mm

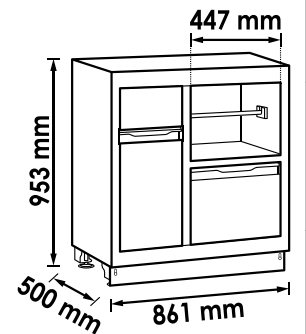
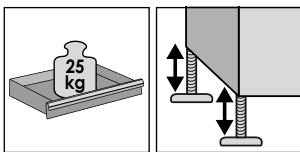

**707,- €**  
zzgl. MwSt.

**V6000-02**, EAN 4047728**048255**

## Doppelflügeltür-Unterschrank

- Einrichtung eines stationären Arbeitsplatzes
- Aufbewahrung von Werkzeugkästen, Arbeitskleidung, Gefäßen oder Kfz-Teilen
- Flügeltür mit Magnet-Verschluss
- Höhenverstellbares Einlegefach
- Innenmaß (L x B x H): 561 x 466,4 x 561 mm
- Erweiterbar mit weiteren Einlegeböden V6000-018
- Gleicht Series L

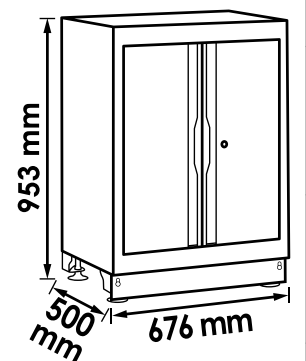
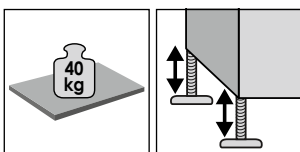

**530,50 €**  
zzgl. MwSt.



**V6000-02XL**, EAN 4047728070355

## Doppelflügeltür-Unterschrank

- Einrichtung eines stationären Arbeitsplatzes
- Aufbewahrung von Werkzeugkästen, Arbeitskleidung, Gefäßen oder Kfz-Teilen
- Flügeltür mit Magnet-Verschluss
- Höhenverstellbares Einlegefach
- Innenmaß (L x B x H): 561 x 466,4 x 561 mm
- Erweiterbar mit weiteren Einlegeböden V6000-018XL
- Gleicht Series XL

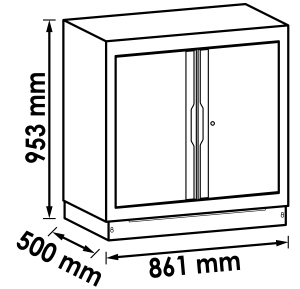

**571,- €**  
zzgl. MwSt.

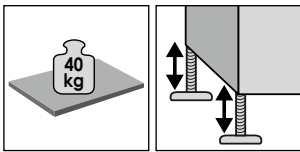

**V6000-02XD**, EAN 4047728081191

## Doppelflügeltür-Unterschrank · extra tief

- Einrichtung eines stationären Arbeitsplatzes
- Aufbewahrung von Werkzeugkästen, Arbeitskleidung, Gefäßen oder Kfz-Teilen
- Flügeltür mit Magnet-Verschluss
- Höhenverstellbares Einlegefach
- Innenmaß (L x B x H): 561 x 466,4 x 561 mm
- In bereits bestehende Systeme nachrüstbar
- Höhenverstellbares Einlegefach
- Gleicht Series XD
- Innenmaß: 787 x 649 x 690 mm (B x T x H)

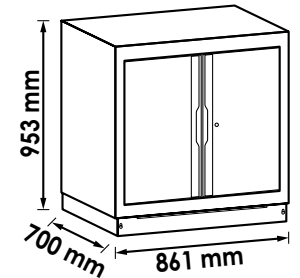

**690,- €**  
zzgl. MwSt.

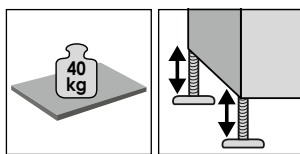

**NEU**

**V6000-011**, EAN 4047728054904

## Eck-Unterschrank

- Eck-Erweiterung für weitere Unterschränke
- Zur Eck-Erweiterung der Schrankwandteile
- Inklusive Einlegefach

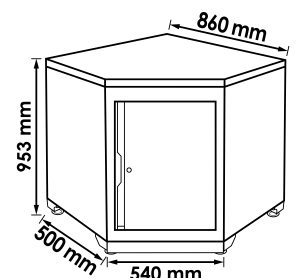

**993,50 €**  
zzgl. MwSt.

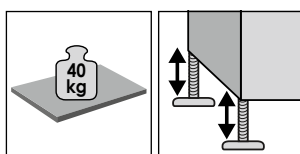

**V6000-037**, EAN 4047728075015

## Brücken-Unterschrank

- Einfache Überbrückung von Arbeitsplatten – Optimal in Verbindung mit 500 mm tiefen Arbeitsplatten
- Schafft viele Arbeitsplatz-Sitzmöglichkeiten und mehr Stauraum in Deiner Werkstatt
- Eine hohe Schublade und ein großes Ablagefach zum Verstauen von Werkzeug
- Belastbarkeit Schublade: 25 kg
- 4 höhenverstellbare (bis 50 mm) FüÙe

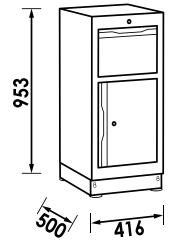
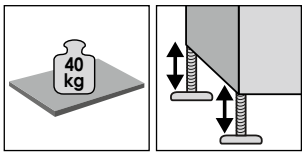

**569,- €**  
zzgl. MwSt.

**V6000-03**, EAN 4047728048262

## Einzelflügeltür-Schrank · hoch

- Aufbewahrung von Werkzeugkästen, Arbeitskleidung, GefäÙen oder Kfz-Teilen
- Schranktür mit Magnet-Verschluss
- Höhenverstellbares Einlegefach
- InnenmaÙ (LxBxH): 484x478x1503,3 / 220,5 mm
- Schranktür sowohl rechts als auch links montierbar
- Erweiterbar mit Einlegeböden V6000-017

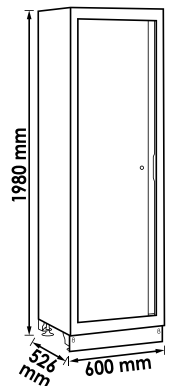
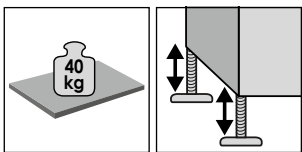

**788,50 €**  
zzgl. MwSt.

**V6000-03XL**, EAN 4047728070362

## Doppelflügeltür-Schrank · hoch

- Aufbewahrung von Werkzeugkästen, Arbeitskleidung, GefäÙen oder Kfz-Teilen
- Schranktür mit Magnet-Verschluss
- Höhenverstellbares Einlegefach
- InnenmaÙ (LxBxH): 1119x510x1812 / 220,5 mm
- Schranktür sowohl rechts als auch links montierbar
- Erweiterbar mit Einlegeböden V6000-017XL

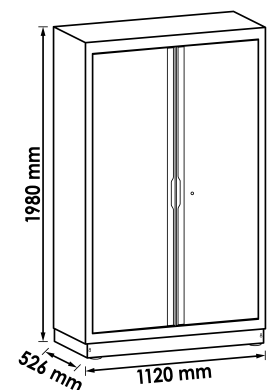
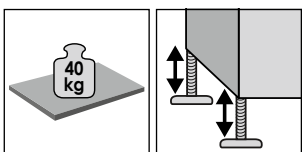

**1.200,- €**  
zzgl. MwSt.



**V6000-04**, EAN 4047728048279

## Hängeschrank

- Aufbewahrung von Werkzeugen, Gefäßen oder KFZ-Teilen

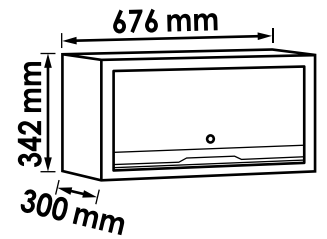

**244,- €**  
zzgl. MwSt.

**V6000-04XL**, EAN 4047728070379

## Hängeschrank

- Aufbewahrung von Werkzeugen, Gefäßen oder KFZ-Teilen

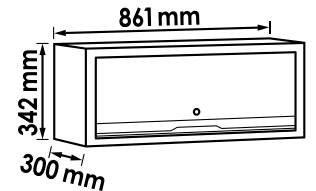

**257,50 €**  
zzgl. MwSt.

**V6000-046**, EAN 4047728073615

## Doppel Flügeltüren-Hängeschrank

- Optimal in Verbindung mit 700 mm tiefen Arbeitsplatten
- Inklusive 1 höhenverstellbarem Einlegeboden
- Belastbarkeit Einlegeboden: 15 kg
- Belastbarkeit Ablageboden: 20 kg
- Flügeltür drehbar auf Links- oder Rechtsanschlag
- Türen mit Magnetverschluss

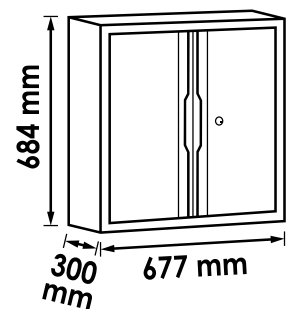

**365,50 €**  
zzgl. MwSt.

**V6000-046XL**, EAN 4047728073622

## Doppel Flügeltüren-Hängeschrank

- Optimal in Verbindung mit 700 mm tiefen Arbeitsplatten
- Inklusive 1 höhenverstellbarem Einlegeboden
- Belastbarkeit Einlegeboden: 15 kg
- Belastbarkeit Ablageboden: 20 kg
- Flügeltür drehbar auf Links- oder Rechtsanschlag
- Türen mit Magnetverschluss

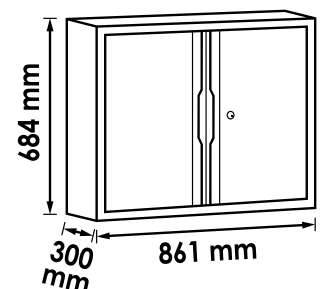

**407,- €**  
zzgl. MwSt.



**V6000-042**, EAN 4047728073363

## Unterschrank-Erweiterungsrahmen

- Erweiterung der Unterschränke auf 700 mm Arbeitstiefe
- Ermöglicht Installation von Lochwand- und Hängeschrank-Trägern
- Erweiterungsrahmen werden rückseitig an einen Unterschrank geschraubt
- Schmale Ausführung · 676 mm

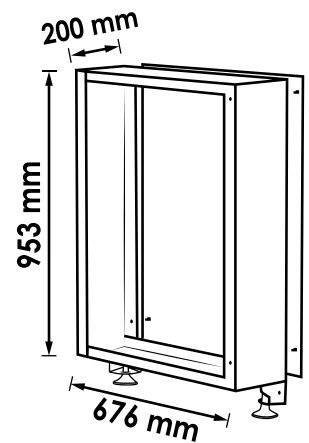
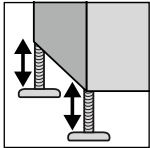

**203,- €**  
zzgl. MwSt.

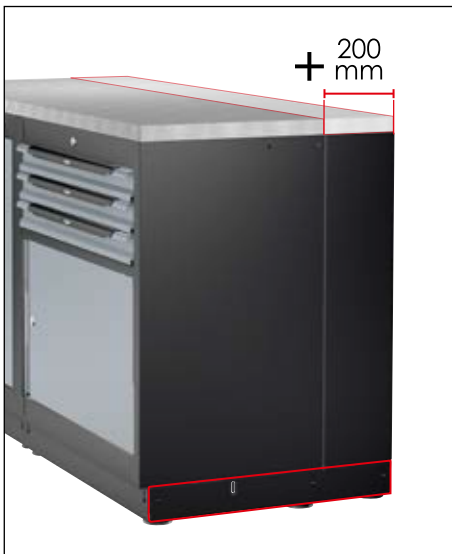

**V6000-042XL**, EAN 4047728073431

## Unterschrank-Erweiterungsrahmen

- Erweiterung der Unterschränke auf 700 mm Arbeitstiefe
- Ermöglicht Installation von Lochwand- und Hängeschrank-Trägern
- Erweiterungsrahmen werden rückseitig an einen Unterschrank geschraubt
- Breite Ausführung · 861 mm

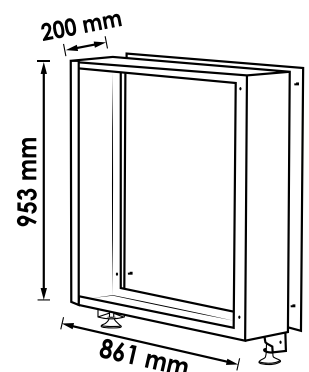
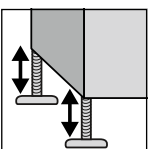

**230,- €**  
zzgl. MwSt.



**V6000-036**, EAN 4047728073356

## Stütz-Unterschrank

- Höhenverstellbar
- Sockelblenden im Lieferumfang enthalten
- Türen mit Magnetverschluss
- 1 Regalboden im Lieferumfang enthalten
- Schmale Ausführung · 500 mm

*Lochwandaufbau auch mit Stützfüßen möglich*

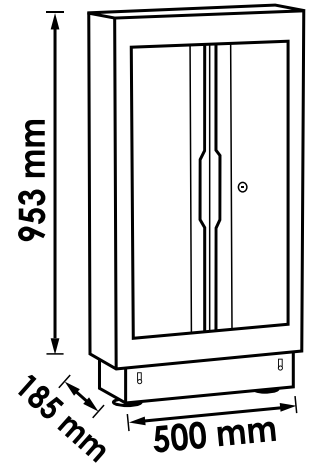

**408,- €**  
zzgl. MwSt.

**V6000-036XL**, EAN 4047728073424

## Stütz-Unterschrank

- Höhenverstellbar
- Sockelblenden im Lieferumfang enthalten
- Türen mit Magnetverschluss
- 1 Regalboden im Lieferumfang enthalten
- Tiefe Ausführung · 700 mm

*Lochwandaufbau auch mit Stützfüßen möglich*

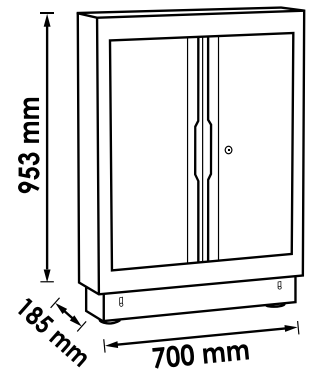

**448,- €**  
zzgl. MwSt.

## Stützfüße

- Höhenverstellbar
- Sichtschutz-Platte im Lieferumfang enthalten

*Lochwandaufbau auch mit Stützfüßen möglich*



VIGOR No.	Bezeichnung	Länge x Breite x Höhe mm	EAN 4047728+	€
V6000-044	Stützfüße	104x500x953	073325	176,-
V6000-044XL	Stützfüße	104x700x953	073370	203,50

# Zubehör Schrankwand-System



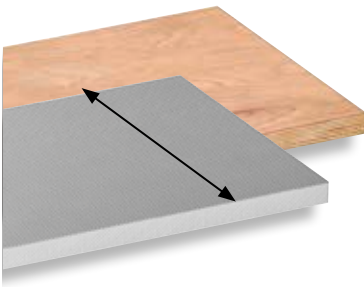

# 500mm



## Holz-Arbeitsplatte

• Befestigung auf Schrankwand-Unterschrank



VIGOR No.	Bezeichnung	Länge x Breite x Höhe mm	EAN 4047728+	€
V6000-0676	Holz-Arbeitsplatte · klein	676 x 500 x 40	073028	211,50
V6000-0861	Holz-Arbeitsplatte · klein	861 x 500 x 40	073042	238,50
V6000-01541	Holz-Arbeitsplatte kombiniert · mittel	1541 x 500 x 40	073141	435,-
V6000-01357	Holz-Arbeitsplatte · mittel	1357 x 500 x 40	073066	347,50
V6000-01725	Holz-Arbeitsplatte · mittel	1725 x 500 x 40	073080	421,-
V6000-02036	Holz-Arbeitsplatte · groß	2036 x 500 x 40	073103	489,50
V6000-02215	Holz-Arbeitsplatte kombiniert · groß	2215 x 500 x 40	073165	557,50
V6000-02404	Holz-Arbeitsplatte kombiniert · groß	2404 x 500 x 40	073189	598,-
V6000-02588	Holz-Arbeitsplatte · groß	2588 x 500 x 40	073127	598,-

## Holz-Arbeitsplatte

VIGOR No.	Bezeichnung	Länge x Breite x Höhe mm	EAN 4047728+	€
V6000-0860	Holz-Arbeitsplatte · Fünfeck	883 x 500 x 40	073202	421,-

## Edelstahl-Arbeitsplatte

• Befestigung auf Schrankwand-Unterschrank



VIGOR No.	Bezeichnung	Länge x Breite x Höhe mm	EAN 4047728+	€
V6000-0676-X	Edelstahl-Arbeitsplatte · klein	676 x 500 x 40	073035	279,50
V6000-0861-X	Edelstahl-Arbeitsplatte · klein	861 x 500 x 40	073059	339,50
V6000-01541-X	Edelstahl-Arbeitsplatte kombiniert · mittel	1541 x 500 x 40	073158	531,50
V6000-01357-X	Edelstahl-Arbeitsplatte · mittel	1357 x 500 x 40	073073	489,50
V6000-01725-X	Edelstahl-Arbeitsplatte · mittel	1725 x 500 x 40	073097	557,50
V6000-02215-X	Edelstahl-Arbeitsplatte kombiniert · groß	2215 x 500 x 40	073172	701,50
V6000-02404-X	Edelstahl-Arbeitsplatte kombiniert · groß	2404 x 500 x 40	073196	770,-
V6000-02036-X	Edelstahl-Arbeitsplatte · groß	2036 x 500 x 40	073110	701,50
V6000-02588-X	Edelstahl-Arbeitsplatte · groß	2588 x 500 x 40	073134	843,50

## Edelstahl-Arbeitsplatte

VIGOR No.	Bezeichnung	Länge x Breite x Höhe mm	EAN 4047728+	€
V6000-0860-X	Edelstahl-Arbeitsplatte · Fünfeck	883 x 500 x 40	073219	634,-

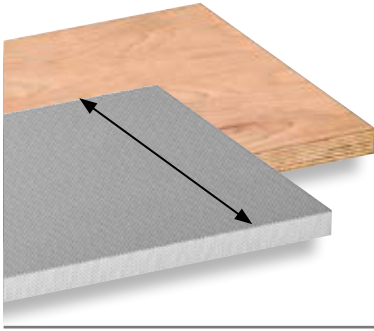

# 700mm



## Holz-Arbeitsplatte

• Befestigung auf Schrankwand-Unterschranken

VIGOR No.	Bezeichnung	Länge x Breite x Höhe mm	EAN 4047728+	€
V6000-0676-D	Holz-Arbeitsplatte Tief · klein	676 x 700 x 40	075794	262,-
V6000-0861-D	Holz-Arbeitsplatte Tief · klein	861 x 700 x 40	075787	309,-
V6000-01357-D	Holz-Arbeitsplatte Tief · mittel	1357 x 700 x 40	073486	435,-
V6000-01725-D	Holz-Arbeitsplatte Tief · mittel	1725 x 700 x 40	073493	516,50
V6000-02036-D	Holz-Arbeitsplatte Tief · groß	2036 x 700 x 40	073509	598,50
V6000-02588-D	Holz-Arbeitsplatte Tief · groß	2588 x 700 x 40	073516	816,50



## Holz-Arbeitsplatte

VIGOR No.	Bezeichnung	Länge x Breite x Höhe mm	EAN 4047728+	€
V6000-01083-D	Holz-Arbeitsplatte Tief · Fünfeck	1083 x 700 x 40	075039	670,-

## Edelstahl-Arbeitsplatte

• Befestigung auf Schrankwand-Unterschranken

VIGOR No.	Bezeichnung	Länge x Breite x Höhe mm	EAN 4047728+	€
V6000-0676-XD	Edelstahl-Arbeitsplatte Tief · klein	676 x 700 x 40	075640	461,50
V6000-0861-XD	Edelstahl-Arbeitsplatte Tief · klein	881 x 700 x 40	075657	503,-
V6000-01357-XD	Edelstahl-Arbeitsplatte Tief · mittel	1357 x 700 x 40	073448	530,50
V6000-01725-XD	Edelstahl-Arbeitsplatte Tief · mittel	1725 x 700 x 40	073455	639,-
V6000-02036-XD	Edelstahl-Arbeitsplatte Tief · groß	2036 x 700 x 40	073462	748,50
V6000-02588-XD	Edelstahl-Arbeitsplatte Tief · groß	2588 x 700 x 40	073479	988,-



## Edelstahl-Arbeitsplatte

VIGOR No.	Bezeichnung	Länge x Breite x Höhe mm	EAN 4047728+	€
V6000-01083-XD	Edelstahl-Arbeitsplatte Tief · Fünfeck	1083 x 700 x 40	075022	859,50



## Lochwandplatten Satz

• Kompatibel mit VIGOR Werkzeughaken Sätzen

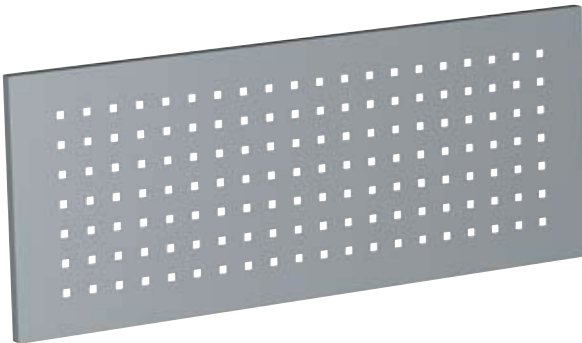

VIGOR No.	Bezeichnung		EAN 4047728+	€
V6000-05	Lochwandplatten Satz · 676 x 342 mm	2	048286	81,60
V6000-015	Lochwandplatten Satz · 861 x 342 mm	2	055260	108,-
V6000-015S	Lochwandplatte · 861 x 301 mm	-	072991	54,35
V6000-015SXL	Lochwandplatte · 861 x 985 mm	-	072984	108,-
V6000-048	Eck-Lochwandplatte	-	076135	62,05
V6000-05S	Lochwandplatte · 676 x 301 mm	-	073011	40,75
V6000-05SXL	Lochwandplatte · 676 x 985 mm	-	073004	81,60

## Lochwandplatte mit Netzversorgung

- Kippschalter zur Deaktivierung der Stromversorgung
- Nur für die unterste Ebene geeignet
- Magnetische Abdeckung schützt vor Verschmutzung
- Integrierte 3-fach Schuko Steckdosenleiste 230 V, 50/60 Hz
- 4 USB-Ports (4x 2,1 A)



VIGOR No.	Bezeichnung	EAN 4047728+	€
V6000-05SP	Lochwandplatte mit Netzversorgung 676 mm	073981	203,-
V6000-015SP	Lochwandplatte mit Netzversorgung 861 mm	073998	230,-

## Regalboden



VIGOR No.	Bezeichnung		Länge x Breite x Höhe mm	EAN 4047728+	€
V6000-017	Regalboden Satz für Einzel-Flügelür-Schrank V6000-03	2	524 x 476 x 13	055420	61,30
V6000-017XL	Regalboden Satz für Doppel-Flügelür-Schrank für V6000-03XL	2	1045 x 476 x 13	070669	130,-

## Regalboden

• Regalboden für V6000-02 · V6000-02XL



VIGOR No.	Bezeichnung	Länge x Breite x Höhe mm	EAN 4047728+	€
V6000-018	Regalboden für Doppel-Flügelür-Unterschrank V6000-02	601 x 464 x 13	059275	57,10
V6000-018XL	Regalboden für Doppel-Flügelür-Unterschrank	785 x 464 x 13	070652	81,60

**V6000-043**, EAN 4047728**073813**

## Sockelblende für Unterschrank mit Erweiterungsrahmen

- Zum sauberen Abschließen der Seitenwände aller Unterschränke mit Erweiterungsrahmen
- Verhindert Eindringen von Staub und Dreck
- Lieferung inklusive Schrauben
- Sockelblende · 650 mm

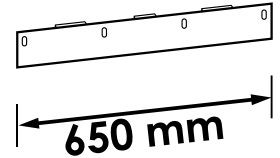

**21,75 €**  
zzgl. MwSt.

**V6000-09**, EAN 4047728**048422**

## Sockelblende für Hochschränke

- Zum sauberen Abschließen der Seitenwände aller Hochschränke
- Verhindert Eindringen von Staub und Dreck
- Lieferung inklusive Schrauben

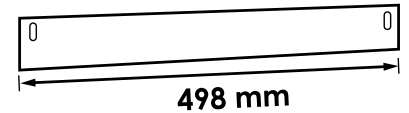

**18,95 €**  
zzgl. MwSt.

**V6000-010**, EAN 4047728**048439**

## Sockelblende für Unterschränke

- Zum sauberen Abschließen der Seitenwände aller Unterschränke
- Verhindert Eindringen von Staub und Dreck
- Lieferung inklusive Schrauben

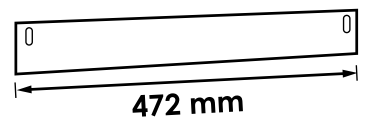

**18,40 €**  
zzgl. MwSt.

**V6000-040/4**, EAN 4047728**070645**

## Verbindungsplättchen Satz

- Rückseitige Verbindung von zwei Unterschränken
- Inhalt: 4 Verbindungsplättchen inklusive Schrauben und Muttern

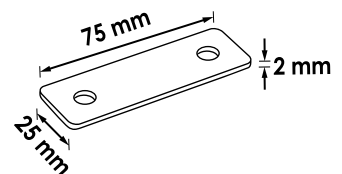

**14,35 €**  
zzgl. MwSt.



**V6000-041/4**, EAN 4047728**070676**

## Regalboden-Träger Satz

- Zur Befestigung von Einlegeböden



**7,50 €**  
zzgl. MwSt.

**V6000-020**, EAN 4047728**069588**

## Ersatzschloss für VIGOR Schrankwand-System

- Inklusive 2 Schlüssel
- Für alle VIGOR Flügeltüren-Schränke:  
V6000-030 · V6000-030XL · V6000-02 · V6000-02XL · V6000-03 · V6000-03XL · V6000-011 · V6000-046 · V6000-046XL



**20,30 €**  
zzgl. MwSt.

**V6000-050**, EAN 4047728**073417**

## Regalboden

- Einfache Aufhängung an 9 x 9 mm Lochwandraster
- Maximale Belastung: 6 kg

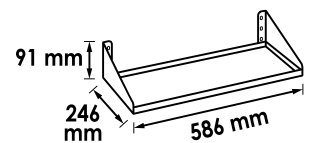
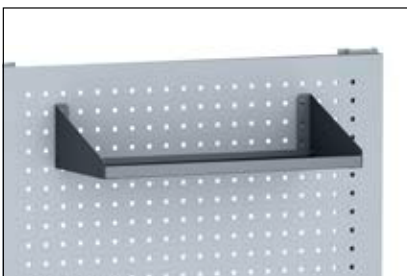

**47,65 €**  
zzgl. MwSt.

**V6000-051**, EAN 4047728**073349**

## Dosenhalter

- Zur Lagerung von Dosen
- Einfache Aufhängung an 9 x 9 mm Lochwandraster

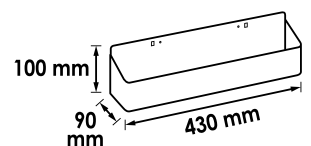
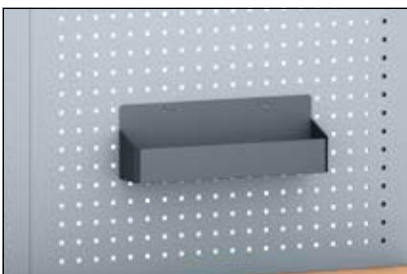

**27,20 €**  
zzgl. MwSt.



**V6000-052**, EAN 4047728073653

## Aufhängeleiste

- Nur in Verbindung mit V6000-053
- Zum Aufhängen von insgesamt 6 Sichtlagerkästen
- Einfache Aufhängung an 9 x 9 mm Lochwandraster

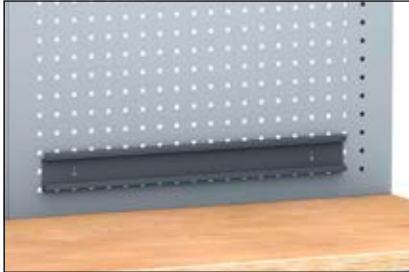

**27,20 €**  
zzgl. MwSt.

**V6000-053**, EAN 4047728074223

## Sichtlagerkasten Satz

- Zur Lagerung von Kleinteilen
- Optimal in Verbindung mit V6000-052
- 3 Sichtlagerkästen im Lieferumfang enthalten
- Maximale Belastung: 3 kg



MADE IN GERMANY



**13,55 €**  
zzgl. MwSt.

**V6000-054**, EAN 4047728074001

## Monitor-Halter

- Kabelführung am Halter
- Halterplatte und Befestigungsmaterial im Lieferumfang enthalten
- Gesamtausladung:
  - Kurzer Schwenkarm: 175 mm
  - Langer Schwenkarm: 265 mm
  - Kurz und lang kombiniert: 350 mm
- Einfache Aufhängung an 9 x 9 mm Lochwandraster
- Maximale Belastung: 5 kg
- 180° schwenkbar

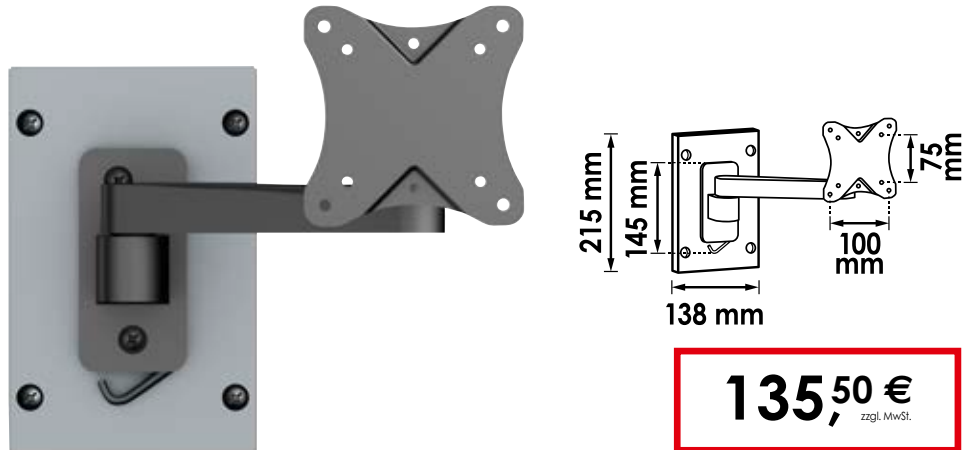

**135,50 €**  
zzgl. MwSt.

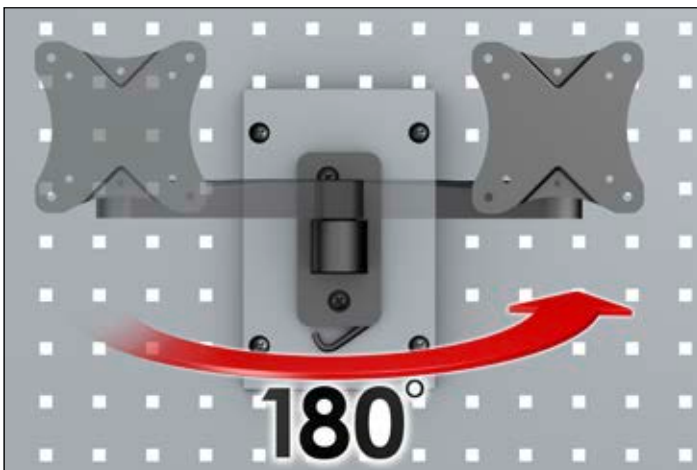

**V6000-055**, EAN 4047728077118

## Drehmomentschlüssel-Halter

- Für gängige Drehmomentschlüssel
- Mit Kantenschutz
- Öffnungsweite 19,5 mm



**17,45 €**  
zzgl. MwSt.



**V6000-055XL**, EAN 4047728077125

## Drehmomentschlüssel-Halter · groß

- Für gängige Drehmomentschlüssel
- Mit Kantenschutz
- Öffnungsweite 26 mm



**17,45 €**  
zzgl. MwSt.

**V6000-047LR**, EAN 4047728076128

## Lochwandträger Satz · links und rechts

- Zur Befestigung von Lochwandplatten und Hängeschränken
- Passend für alle VIGOR Lochwandplatten
- Schrankwandaufbau von vorne dank zusätzlich eingesetzter Gewindehülsen
- Vollflächige Aufhängung von Lochwandplatten möglich
- Zusatzlochungen für Wandmontage vorhanden
- Befestigung rückseitig an den Außenpositionen der Unterschränke



**V6000-047M**, EAN 4047728076111

## Lochwandträger · mittig

- Zur Befestigung von Lochwandplatten und Hängeschränken
- Passend für alle VIGOR Lochwandplatten
- Schrankwandaufbau von vorne dank zusätzlich eingesetzter Gewindehülsen
- Vollflächige Aufhängung von Lochwandplatten möglich
- Zusatzlochungen für Wandmontage vorhanden
- Befestigung rückseitig an den Innenpositionen der Unterschränke

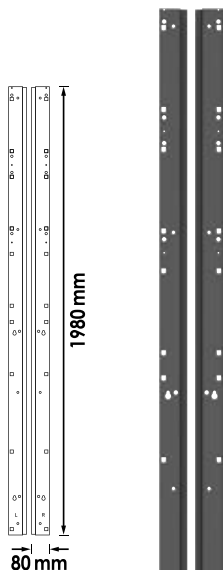

**92,45 €**  
zzgl. MwSt.

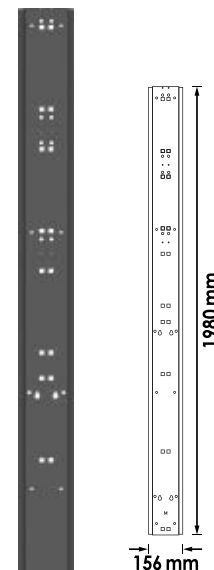

**78,40 €**  
zzgl. MwSt.

**V7283**, EAN 4047728072847

## LED Lichtleiste · Erweiterung

- Optimale Beleuchtung für Werkstatt, Keller, Wohnraum oder Gartenhütten
- Magnetische Rückseite zur Befestigung an eisenhaltigen Untergründen
- Klebestreifen für nicht magnetische Untergründe im Lieferumfang enthalten
- Robustes Aluminium-Gehäuse
- Länge LED-Lichtleiste: 527 mm
- Gesamtlänge (inklusive Kabel): 2527 mm
- Leistung: 1000 lm
- Maximal 3 LED-Lichtleisten pro Netzteil kombinierbar

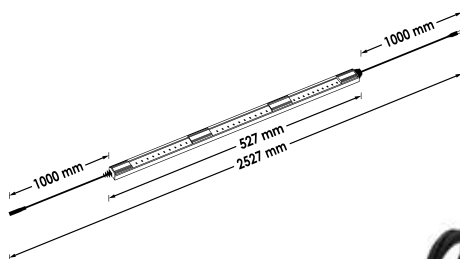

**34,80 €**  
zzgl. MwSt.

**V7283/2**, EAN 4047728072830

## LED Lichtleiste · Basis Satz

- Optimale Beleuchtung für Werkstatt, Keller, Wohnraum oder Gartenhütten
- Magnetische Rückseite zur Befestigung an eisenhaltigen Untergründen
- Klebestreifen für nicht magnetische Untergründe im Lieferumfang enthalten
- Robustes Aluminium-Gehäuse
- Länge LED-Lichtleiste: 527 mm
- Gesamtlänge (inklusive Kabel): 2527 mm
- Leistung: 1000 lm
- Maximal 3 LED-Lichtleisten pro Netzteil kombinierbar
- Inklusive ON/OFF Schalter
- Inklusive Netzteil 230 V, 1,5 A Output

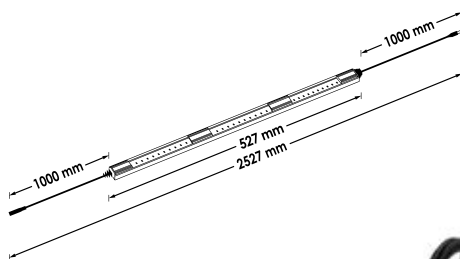

**54,- €**  
zzgl. MwSt.



电

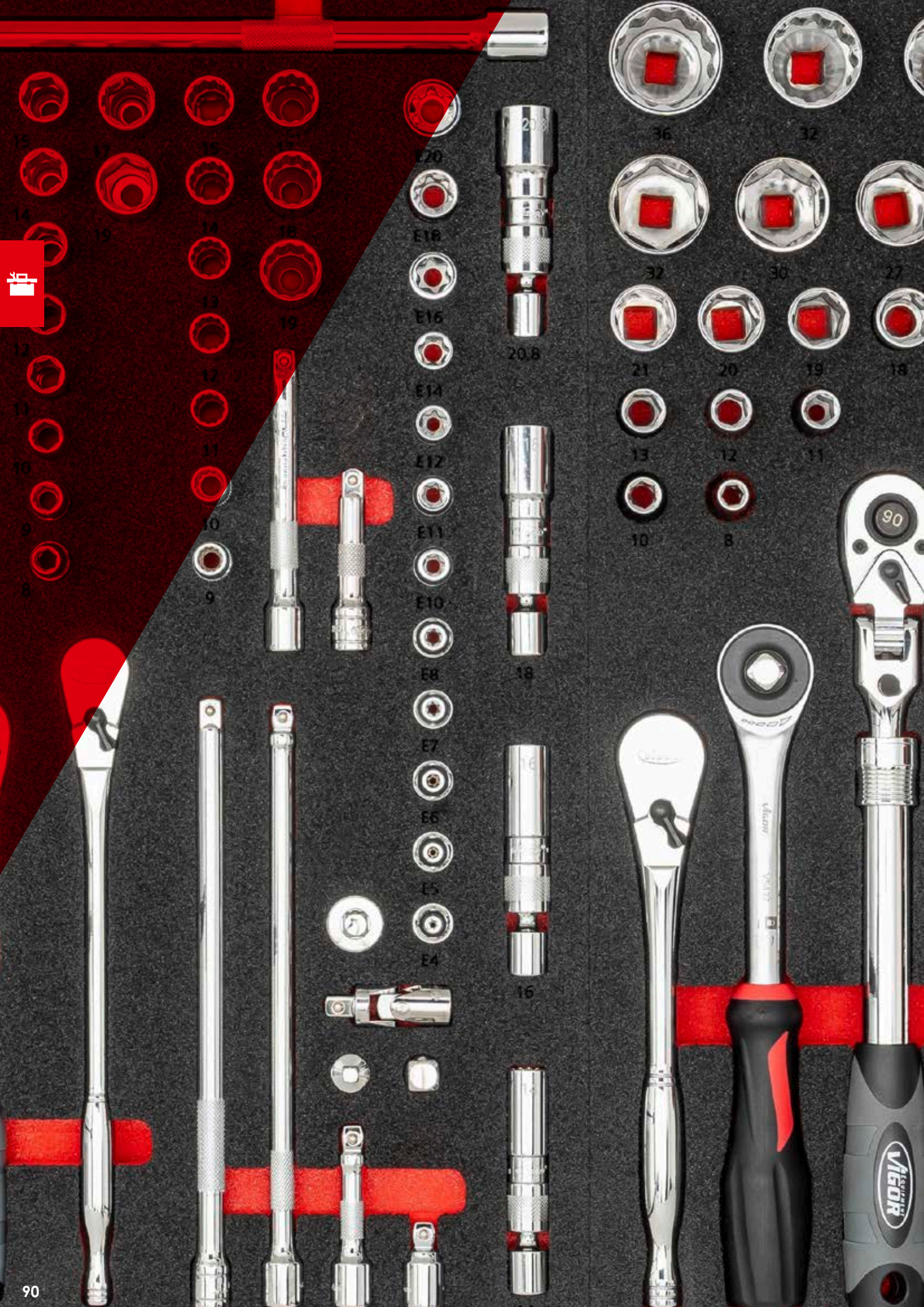

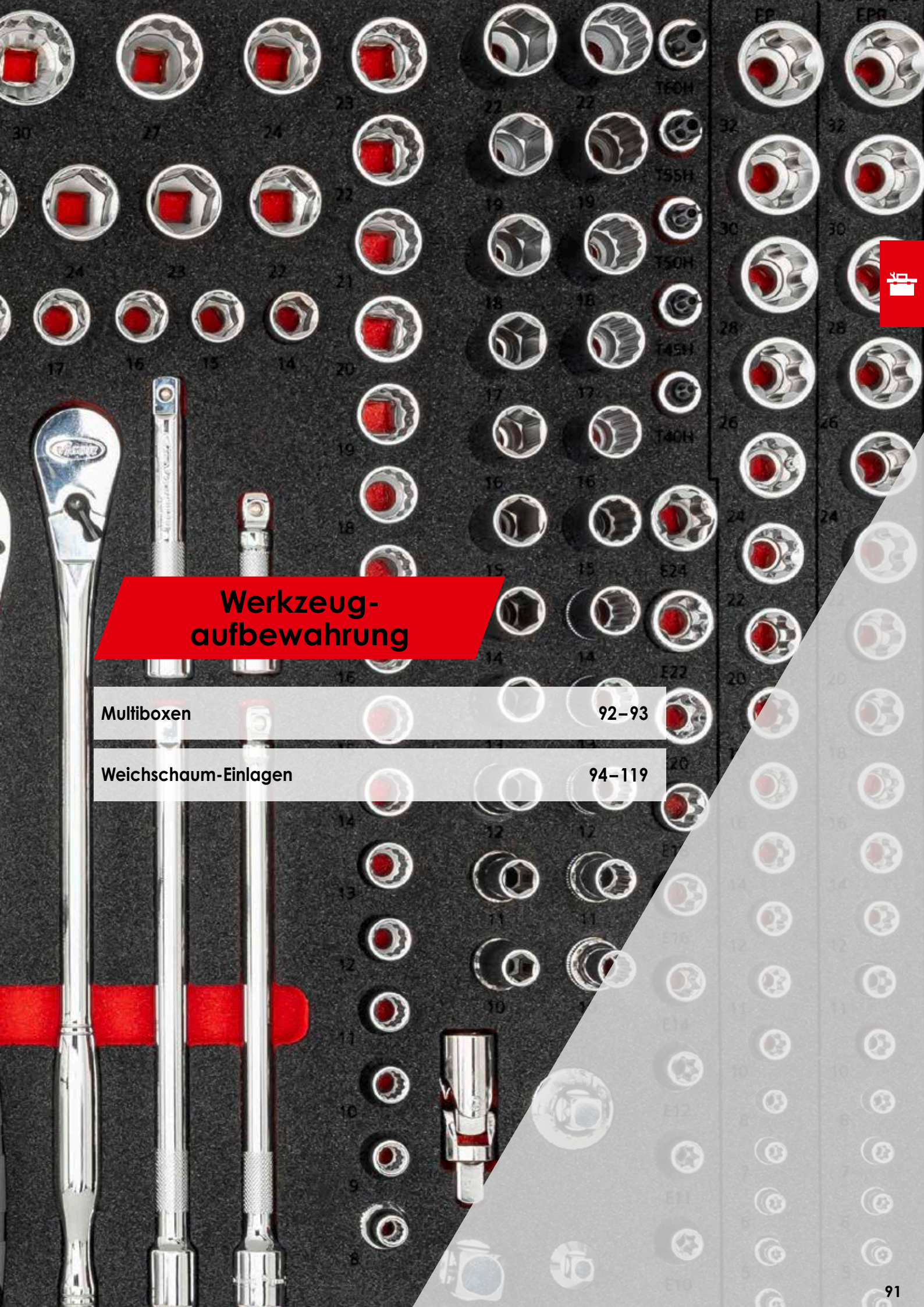

# Werkzeug- aufbewahrung

Multiboxen 92-93

Weichschaum-Einlagen 94-119

**V4700-L**, EAN 4047728**046794**

**Multibox-L · leer**

- Leichtgewichtige Kunststoff-Box
- Maximale Belastbarkeit: 90 kg

M

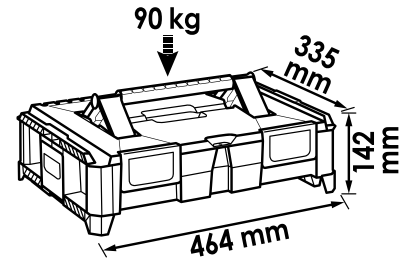

Innenmaße:  
80 mm / 300 mm  
400 mm



**57,65 €**  
zzgl. MwSt.



**V4700-XL**, EAN 4047728**049269**

**Multibox-XL · leer**

- Leichtgewichtige Kunststoff-Box
- Maximale Belastbarkeit: 90 kg

M

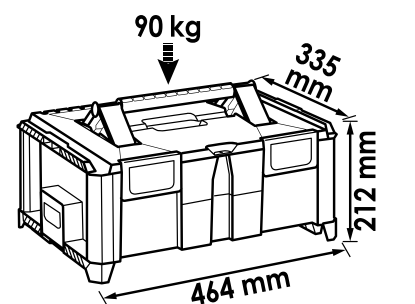

Innenmaße:  
150 mm / 300 mm  
400 mm



**68,15 €**  
zzgl. MwSt.

# Multiboxen



**V4700-XXL**, EAN 4047728**049276**

## Multibox-XXL · leer

- Leichtgewichtige Kunststoff-Box
- Maximale Belastbarkeit: 90 kg

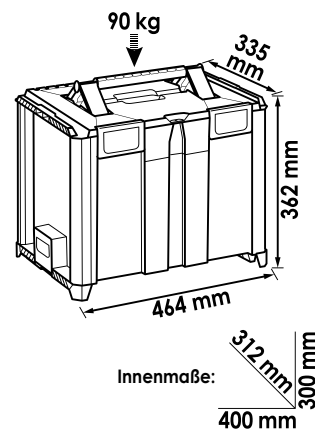

**85,95 €**  
zzgl. MwSt.

**V4700-A**, EAN 4047728**075077**

## Erweiterungssatz Multibox

- Zum Kombinieren der VIGOR Multiboxen mit Fremdfabrikaten
- Einfaches Click-System für schnelle Verbindungen
- Erweiterungssatz Multibox



**12,55 €**  
zzgl. MwSt.

**V4700-R**, EAN 4047728**049283**

## Rollbrett für Multibox

- Rollbrett für V4700-L · V4700-XL und V4700-XXL
- Maximale Belastbarkeit: 200 kg

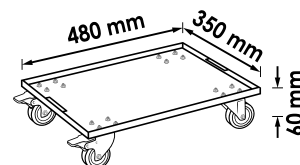

**61,85 €**  
zzgl. MwSt.



## Erklärung Schubladen-Piktogramme

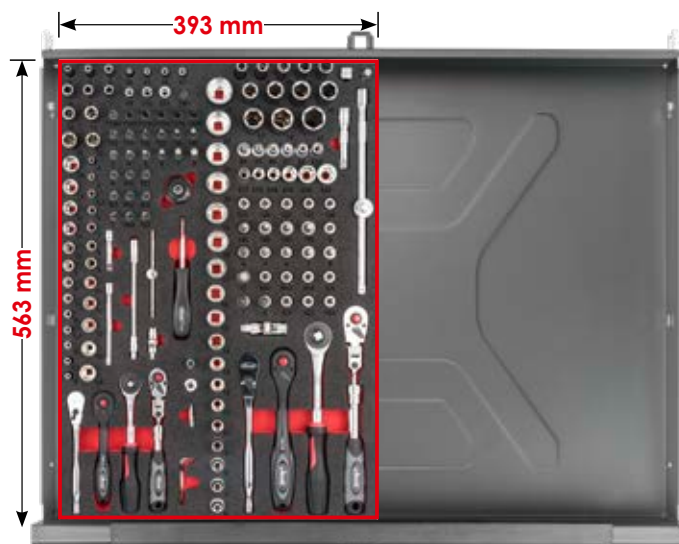
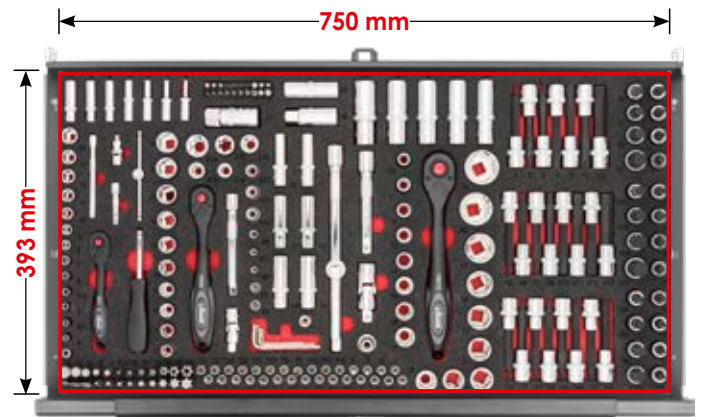
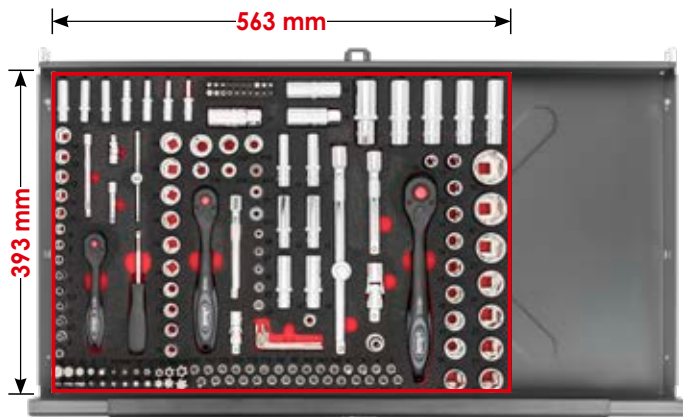
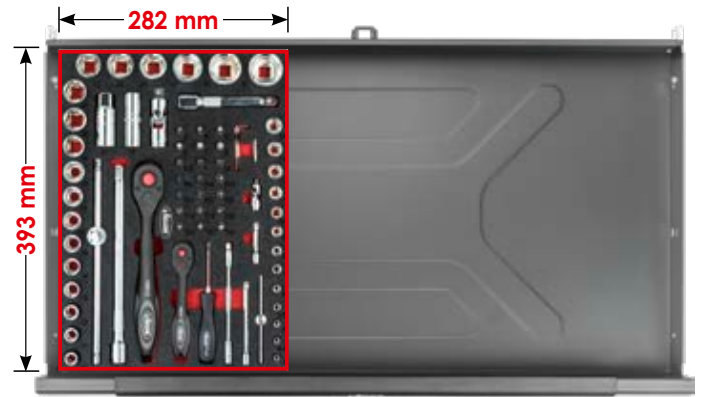



# Weichschaum-Einlagen



**V4971**, EAN 4047728049719  
Steckschlüssel Werkzeug Satz



**118,50 €**  
zzgl. MwSt.

XX	■	Ausführung	SW
13 x	6.3 1/4		4 · 4.5 · 5 · 5.5 · 6 · 7 · 8 · 9 · 10 · 11 · 12 · 13 · 14 mm
7 x	6.3 1/4		4 · 5 · 6 · 7 · 8 · 9 · 10 mm
7 x	6.3 1/4		E4 · E5 · E6 · E7 · E8 · E10 · E11
6 x	6.3 1/4		3 · 4 · 5 · 6 · 7 · 8 mm
3 x	6.3 1/4		PH1 · PH2 · PH3
3 x	6.3 1/4		0.8x4-1x5.5-1.2x7 mm
3 x	6.3 1/4		PZ1 · PZ2 · PZ3
6 x	6.3 1/4		T10 · T15 · T20 · T25 · T30 · T40

XX	■	Ausführung	SW
7 x	6.3 1/4		T9H · T10H · T15H · T20H · T25H · T27H · T30H
1 x	-	6.3 1/4	150 mm
1 x	6.3 1/4	6.3 1/4	40 mm
1 x	10 3/8	6.3 1/4	27 mm
1 x	6.3 1/4	6.3 1/4	110 mm
1 x	6.3 1/4	6.3 1/4	145 mm
1 x	6.3 1/4	6.3 1/4	50 mm
1 x	6.3 1/4	6.3 1/4	100 mm
2 x	-		1.3 · 2 mm
1 x	-	6.3 1/4	150 mm

**V4971-L**, EAN 4047728049702  
Weichschaum-Einlage · leer

**26,75 €**  
zzgl. MwSt.

**V4973**, EAN 4047728049733  
Steckschlüssel Werkzeug Satz



**147,50 €**  
zzgl. MwSt.

XX	■	Ausführung	SW
18 x	10 3/8		6 · 7 · 8 · 9 · 10 · 11 · 12 · 13 · 14 · 15 · 16 · 17 · 18 · 19 · 20 · 21 · 22 · 24 mm
10 x	10 3/8		8 · 9 · 10 · 11 · 12 · 13 · 14 · 15 · 17 · 19 mm
7 x	10 3/8		3 · 4 · 5 · 6 · 7 · 8 · 10 mm
3 x	10 3/8		0.8x5.5-1x7-1.2x8 mm
3 x	10 3/8		PH1 · PH2 · PH3

XX	■	Ausführung	SW
3 x	10 3/8		PZ1 · PZ2 · PZ3
9 x	10 3/8		T15 · T20 · T25 · T27 · T30 · T40 · T45 · T50 · T55
2 x	10 3/8		16 · 21 mm
1 x	10 3/8	10 3/8	28 mm
1 x	12 3/8	10 3/8	40 mm
1 x	10 3/8	10 3/8	50 mm
1 x	10 3/8	10 3/8	75 mm
1 x	10 3/8	10 3/8	250 mm
1 x	-	10 3/8	198 mm

**V4973-L**, EAN 4047728049726  
Weichschaum-Einlage · leer

**26,75 €**  
zzgl. MwSt.

**V4975**, EAN 4047728049757  
Steckschlüssel Werkzeug Satz



**167,- €**  
zzgl. MwSt.

XX	■	Ausführung	SW
18 x	12 3/8 1/2		10 · 11 · 12 · 13 · 14 · 15 · 16 · 17 · 18 · 19 · 20 · 21 · 22 · 23 · 24 · 27 · 30 · 32 mm
2 x	12 3/8 1/2		16 · 21 mm

XX	■	Ausführung	SW
1 x	-	12 3/8 1/2	250 mm
1 x	12 3/8 1/2	12 3/8 1/2	75 mm
1 x	12 3/8 1/2	12 3/8 1/2	125 mm
1 x	12 3/8 1/2	12 3/8 1/2	250 mm
1 x	-	12 3/8 1/2	250 mm

**V4975-L**, EAN 4047728049740  
Weichschaum-Einlage · leer

**26,75 €**  
zzgl. MwSt.



**V7323**, EAN 4047728073240  
Steckschlüssel Satz



**86,35 €**  
zzgl. MwSt.

XX	■	Ausführung	SW
3 x	6.3 1/4		11 · 12 · 13 mm
5 x	10 3/8		E10 · E12 · E14 · E16 · E18
8 x	12.5 1/2		10 · 12 · 14 · 16 · 17 · 18 · 19 · 22 mm

XX	■	Ausführung	SW
5 x	12.5 1/2		E14 · E16 · E18 · E20 · E22
5 x	12.5 1/2		15 · 17 · 19 · 21 · 22 mm

**V7323-L**, EAN 4047728073233  
Weichschaum-Einlage · leer

**26,75 €**  
zzgl. MwSt.

**V5602**, EAN 4047728056021  
Schlagschrauber Steckschlüsseleinsatz Satz



**143,- €**  
zzgl. MwSt.

XX	■	Ausführung	SW
13 x	12.5 1/2		10 · 11 · 12 · 13 · 14 · 15 · 16 · 17 · 18 · 19 · 21 · 22 · 24 mm

XX	■	Ausführung	SW
13 x	12.5 1/2		10 · 11 · 12 · 13 · 14 · 15 · 16 · 17 · 18 · 19 · 21 · 22 · 24 mm

**V5602-L**, EAN 4047728056038  
Weichschaum-Einlage · leer

**26,75 €**  
zzgl. MwSt.

**V5099**, EAN 4047728050999  
Schraubendreher-Einsatz Satz

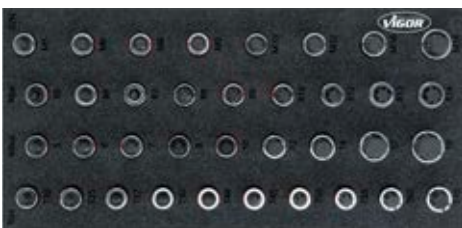

**156,- €**  
zzgl. MwSt.

XX	■	Ausführung	SW
10 x	12.5 1/2		T20 · T25 · T27 · T30 · T40 · T45 · T50 · T55 · T60 · T70
9 x	12.5 1/2		M5 · M6 · M7 · M8 · M9 · M10 · M12 · M13 · M14

XX	■	Ausführung	SW
9 x	12.5 1/2		5 · 6 · 7 · 8 · 10 · 12 · 14 · 17 · 19 mm
8 x	12.5 1/2		M5 · M6 · M8 · M9 · M10 · M12 · M14 · M16

**V5099-L**, EAN 4047728051002  
Weichschaum-Einlage · leer

**26,75 €**  
zzgl. MwSt.

**V5095**, EAN 4047728050951  
T Schraubendreher-Einsatz Satz



**132,- €**  
zzgl. MwSt.

XX	■	Ausführung	SW
6 x	12.5 1/2		T40 · T45 · T50 · T55 · T60 · T70
10 x	12.5 1/2		T20 · T25 · T27 · T30 · T40 · T45 · T50 · T55 · T60 · T70

XX	■	Ausführung	SW
10 x	12.5 1/2		T20 · T25 · T27 · T30 · T40 · T45 · T50 · T55 · T60 · T70

**V5095-L**, EAN 4047728050968  
Weichschaum-Einlage · leer

**26,75 €**  
zzgl. MwSt.

# Weichschaum-Einlagen



**V5091**, EAN 4047728050913  
Innenvielzahn Schraubendreher-Einsatz Satz (XZN)

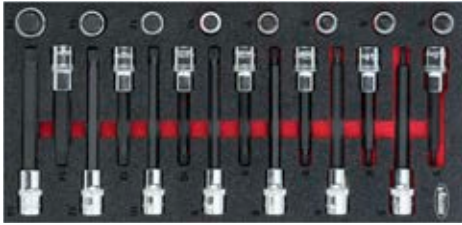

**132,- €**  
zzgl. MwSt.

XX			Ausführung	SW
7 x	129	1/2		M5 · M6 · M8 · M9 · M10 · M12 · M14
7 x	129	1/2		M5 · M6 · M8 · M9 · M10 · M12 · M14

XX			Ausführung	SW
8 x	129	1/2		M5 · M6 · M8 · M9 · M10 · M12 · M14 · M16

**V5091-L**, EAN 4047728050920  
Weichschaum-Einlage · leer

**26,75 €**  
zzgl. MwSt.

**V5097**, EAN 4047728050975  
Innensechskant Schraubendreher-Einsatz Satz



**132,- €**  
zzgl. MwSt.

XX			Ausführung	SW
7 x	129	1/2		5 · 6 · 7 · 8 · 10 · 12 · 14 mm
8 x	129	1/2		5 · 6 · 7 · 8 · 10 · 11 · 12 · 13 mm

XX			Ausführung	SW
9 x	129	1/2		5 · 6 · 7 · 8 · 10 · 12 · 14 · 17 · 19 mm

**V5097-L**, EAN 4047728050982  
Weichschaum-Einlage · leer

**26,75 €**  
zzgl. MwSt.

**V6721**, EAN 4047728067461  
Doppel-Maulschlüssel Satz



**89,95 €**  
zzgl. MwSt.

XX		Ausführung	SW
12 x			6 x 7 · 8 x 9 · 10 x 11 · 12 x 13 · 14 x 15 · 16 x 17 · 18 x 19 · 20 x 22 · 21 x 23 · 24 x 27 · 25 x 28 · 30 x 32 mm

**V6721-L**, EAN 4047728067218  
Weichschaum-Einlage · leer

**26,75 €**  
zzgl. MwSt.

**V6723**, EAN 4047728067485  
Ring-Maulschlüssel Satz



**114,50 €**  
zzgl. MwSt.

XX		Ausführung	SW
18 x			6 · 7 · 8 · 9 · 10 · 11 · 12 · 13 · 14 · 15 · 16 · 17 · 18 · 19 · 21 · 22 · 24 · 27 mm

**V6723-L**, EAN 4047728067232  
Weichschaum-Einlage · leer

**26,75 €**  
zzgl. MwSt.



**V6722**, EAN 4047728067478  
Doppel-Ringschlüssel Satz



XX	Ausführung	SW
11 x		6x7 · 8x9 · 10x11 · 12x13 · 14x15 · 16x17 · 18x19 · 20x22 · 21x23 · 24x27 · 25x28 mm

**155,- €**  
zzgl. MwSt.

**V6722-L**, EAN 4047728067225  
Weichschaum-Einlage · leer

**26,75 €**  
zzgl. MwSt.

**V5075**, EAN 4047728050753  
Ratschen Ring-Maulschlüssel Satz · kurz



XX	Ausführung	SW
12 x		8 · 9 · 10 · 11 · 12 · 13 · 14 · 15 · 16 · 17 · 18 · 19 mm

**217,- €**  
zzgl. MwSt.

**V5075-L**, EAN 4047728050760  
Weichschaum-Einlage · leer

**26,75 €**  
zzgl. MwSt.

**V4987**, EAN 4047728049870  
Ratschen Ring-Maulschlüssel Satz

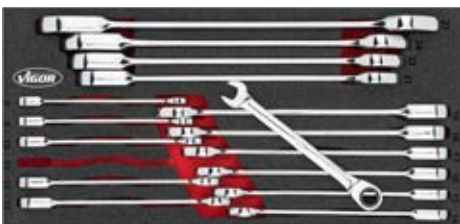

XX	Ausführung	SW
16 x		8 · 9 · 10 · 11 · 12 · 13 · 14 · 15 · 16 · 17 · 18 · 19 · 21 · 22 · 24 · 27 mm

**310,50 €**  
zzgl. MwSt.

**V4987-L**, EAN 4047728049863  
Weichschaum-Einlage · leer

**26,75 €**  
zzgl. MwSt.

**V5077**, EAN 4047728050777  
Gelenk Ratschen Ring-Maulschlüssel Satz



XX	Ausführung	SW
12 x		8 · 9 · 10 · 11 · 12 · 13 · 14 · 15 · 16 · 17 · 18 · 19 mm

**258,50 €**  
zzgl. MwSt.

**V5077-L**, EAN 4047728050784  
Weichschaum-Einlage · leer

**26,75 €**  
zzgl. MwSt.

# Weichschaum-Einlagen



**V4989**, EAN 4047728**049894**  
Schraubendreher Satz



**68,40 €**  
zzgl. MwSt.

XX	Ausführung	SW
6 x		0.6x3 · 0.8x4 · 1x5.5 · 1.2x6.5 · 1.6x8 · 1.6x10 mm
1 x		PH3
1 x		1x5.5 mm

XX	Ausführung	SW
1 x		PH2
3 x		PH1 · PH2 · PH3

**V4989-L**, EAN 4047728**049887**  
Weichschaum-Einlage · leer

**26,75 €**  
zzgl. MwSt.

**V5068**, EAN 4047728**050685**  
Schraubendreher Satz mit Schlagkappe



**99,55 €**  
zzgl. MwSt.

XX	Ausführung	SW
3 x		PH1 · PH2 · PH3

XX	Ausführung	SW
7 x		0.6x3.5-1x4.5-1x5.5 · 1.2x6.5 · 1.6x8 · 1.6x10 · 2x12 mm

**V5068-L**, EAN 4047728**050678**  
Weichschaum-Einlage · leer

**26,75 €**  
zzgl. MwSt.

**V4991**, EAN 4047728**049917**  
T Schraubendreher Satz



**60,- €**  
zzgl. MwSt.

XX	Ausführung	SW
11 x		T6 · T7 · T8 · T9 · T10 · T15 · T20 · T25 · T27 · T30 · T40

**V4991-L**, EAN 4047728**049900**  
Weichschaum-Einlage · leer

**26,75 €**  
zzgl. MwSt.

**V4995**, EAN 4047728**049955**  
Doppelgelenk Zangen Satz



**215,- €**  
zzgl. MwSt.

XX	Ausführung	SW
1 x		340 mm
1 x		335 mm

XX	Ausführung	SW
1 x		300 mm
1 x		290 mm

**V4995-L**, EAN 4047728**049948**  
Weichschaum-Einlage · leer

**26,75 €**  
zzgl. MwSt.



**V5004**, EAN 4047728050043

Grip-Zangen Satz



**118,50 €**  
zzgl. MwSt.

XX	Ausführung	SW
1 x		16 – 27 mm
1 x		11 – 19 mm
1 x		125 mm

XX	Ausführung	SW
1 x		250 mm
1 x		150 mm

**V5004-L**, EAN 4047728050005

Weichschaum-Einlage · leer

**26,75 €**  
zzgl. MwSt.

**V6222**, EAN 4047728062374

Hammer-, Meißel- und Splintreiber Satz



**134,50 €**  
zzgl. MwSt.

XX	Ausführung	SW
1 x		Ø 4 mm
1 x		18 mm
1 x		6 mm

XX	Ausführung	SW
1 x		500 g
7 x		Ø 2 · 3 · 4 · 5 · 6 · 7 · 8 mm

**V6222-L**, EAN 4047728062633

Weichschaum-Einlage · leer

**26,75 €**  
zzgl. MwSt.

**V5006**, EAN 4047728050067

Hammer- und Meißel Satz



**107,- €**  
zzgl. MwSt.

XX	Ausführung	SW
1 x		6 mm
1 x		18 mm
1 x		Ø 4 mm

XX	Ausführung	SW
6 x		Ø 2 · 3 · 4 · 5 · 6 · 8 mm
1 x		Ø 40 mm
1 x		800 g

**V5006-L**, EAN 4047728050050

Weichschaum-Einlage · leer

**26,75 €**  
zzgl. MwSt.

**V5070**, EAN 4047728050708

Haken- und Schaber Satz



**64,80 €**  
zzgl. MwSt.

XX	Ausführung	SW
1 x		130 mm
1 x		130 mm
1 x		130 mm
1 x		130 mm
1 x		260 mm

XX	Ausführung	SW
1 x		260 mm
1 x		260 mm
1 x		260 mm
1 x		260 mm

**V5070-L**, EAN 4047728050692

Weichschaum-Einlage · leer

**26,75 €**  
zzgl. MwSt.

# Weichschaum-Einlagen



**V5017**, EAN 4047728050173  
Schaber Satz



**95,95 €**  
zzgl. MwSt.

XX	Ausführung	SW
1 x		22 mm
1 x		32 mm
1 x		32 mm
1 x		20 mm

XX	Ausführung	SW
1 x		20 mm
1 x		40 mm
1 x		10 x

**V5017-L**, EAN 4047728050166  
Weichschaum-Einlage · leer

**26,75 €**  
zzgl. MwSt.

**V5072**, EAN 4047728050722  
Feilen Satz



**73,20 €**  
zzgl. MwSt.

XX	Ausführung	SW
1 x		310 mm
1 x		310 mm
1 x		310 mm

XX	Ausführung	SW
1 x		310 mm
1 x		310 mm

**V5072-L**, EAN 4047728050715  
Weichschaum-Einlage · leer

**26,75 €**  
zzgl. MwSt.

**V5011**, EAN 4047728050111  
VDE Steckschlüssel Satz



**370,50 €**  
zzgl. MwSt.

XX	Ausführung	SW
9 x		8 · 10 · 12 · 13 · 14 · 17 · 19 · 22 · 24 mm
3 x		5 · 6 · 8 mm

XX	Ausführung	SW
1 x		125 mm
1 x		255 mm

**V5011-L**, EAN 4047728050104  
Weichschaum-Einlage · leer

**26,75 €**  
zzgl. MwSt.

**V5013**, EAN 4047728050135  
VDE Schraubendreher Satz



**62,40 €**  
zzgl. MwSt.

XX	Ausführung	SW
3 x		PH0 · PH1 · PH2
4 x		0.5x3 · 0.8x4 · 1x5.5 · 1.2x6.5 mm

XX	Ausführung	SW
1 x		0.5x3 mm

**V5013-L**, EAN 4047728050128  
Weichschaum-Einlage · leer

**26,75 €**  
zzgl. MwSt.



**V5015**, EAN 4047728050159

VDE Zangen Satz

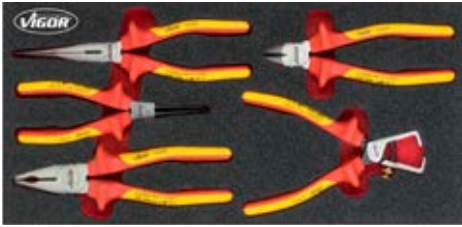

**167,- €**  
zzgl. MwSt.

XX	Ausführung	SW
1 x		180 mm
1 x		160 mm
1 x		160 mm

XX	Ausführung	SW
1 x		200 mm
1 x		160 mm

**V5015-L**, EAN 4047728050142

Weichschaum-Einlage · leer

**26,75 €**  
zzgl. MwSt.

**V4999N**, EAN 4047728078726

Zangen Satz

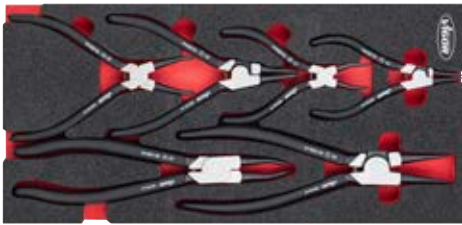

**149,- €**  
zzgl. MwSt.

XX	Ausführung	SW
3 x		140 · 180 · 230 mm

XX	Ausführung	SW
3 x		140 · 180 · 230 mm

**V4999N-L**, EAN 4047728077989

Weichschaum-Einlage · leer

**26,75 €**  
zzgl. MwSt.

**V5603**, EAN 4047728078917

Schlagschrauber Schraubendreher-Einsatz Satz



**227,- €**  
zzgl. MwSt.

XX	■	Ausführung	SW
8 x			5 · 6 · 8 · 10 · 12 · 14 · 17 · 19 mm
8 x			M5 · M6 · M8 · M10 · M12 · M14 · M16 · M18

XX	■	Ausführung	SW
8 x			T30 · T40 · T45 · T50 · T55 · T60 · T70 · T80

**V5603-L**, EAN 4047728078580

Weichschaum-Einlage · leer

**26,75 €**  
zzgl. MwSt.

**V5633N**, EAN 4047728078740

Zangen Satz



**110,50 €**  
zzgl. MwSt.

XX	Ausführung	SW
1 x		250 mm
1 x		200 mm

XX	Ausführung	SW
1 x		180 mm
1 x		160 mm

**V5633N-L**, EAN 4047728078009

Weichschaum-Einlage · leer

**26,75 €**  
zzgl. MwSt.



# Weichschaum-Einlagen



**V7324**, EAN 4047728080262

Schlagschrauber  
Steckschlüsseleinsatz Satz

**NEU**



**249,- €**  
zzgl. MwSt.

XX	■	Ausführung	SW
9 x	12.9 1/2		10 · 11 · 12 · 13 · 14 · 15 · 16 · 17 · 19 mm
13 x	12.9 1/2		10 · 11 · 12 · 13 · 14 · 15 · 16 · 17 · 18 · 19 · 21 · 22 · 24 mm
5 x	12.9 1/2		15 · 17 · 19 · 21 · 22 mm

XX	■	Ausführung	SW
1 x	12.9 1/2		17 mm
1 x	12.9 1/2		18.5 · 19.5 mm
1 x	12.9 1/2		21 mm
1 x	12.9 1/2		22.2 mm

**V7324-L**, EAN 4047728080248

Weichschaum-Einlage · leer

**26,75 €**  
zzgl. MwSt.

**V7520**, EAN 4047728075824

Doppelsechskant-Steckschlüssel Satz

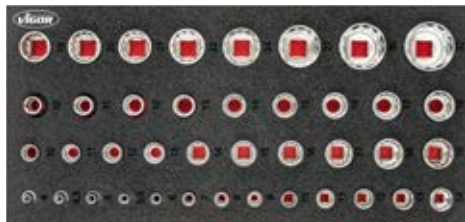

**155,- €**  
zzgl. MwSt.

XX	■	Ausführung	SW
17 x	12.9 1/2		10 · 11 · 12 · 13 · 14 · 15 · 16 · 17 · 18 · 19 · 20 · 21 · 22 · 24 · 27 · 30 · 32 mm
10 x	10		10 · 11 · 12 · 13 · 14 · 15 · 16 · 17 · 18 · 19 mm

XX	■	Ausführung	SW
13 x	6.3 1/4		4 · 4.5 · 5 · 5.5 · 6 · 7 · 8 · 9 · 10 · 11 · 12 · 13 · 14 mm

**V7520-L**, EAN 4047728075800

Weichschaum-Einlage · leer

**26,75 €**  
zzgl. MwSt.

**V5103**, EAN 4047728051033

Steckschlüssel Satz



**186,- €**  
zzgl. MwSt.

XX	■	Ausführung	SW
13 x	6.3 1/4		4 · 4.5 · 5 · 5.5 · 6 · 7 · 8 · 9 · 10 · 11 · 12 · 13 · 14 mm
6 x	6.3 1/4		3 · 4 · 5 · 6 · 7 · 8 mm
3 x	6.3 1/4		PH1 · PH2 · PH3
3 x	6.3 1/4		PZ1 · PZ2 · PZ3
3 x	6.3 1/4		0.8x4-1x5.5-1.2x7 mm
6 x	6.3 1/4		T10 · T15 · T20 · T25 · T30 · T40
1 x	-	6.3 1/4	150 mm
1 x	6.3 1/4	6.3 1/4	110 mm
1 x	6.3 1/4	6.3 1/4	40 mm
1 x	6.3 1/4	6.3 1/4	145 mm

XX	■	Ausführung	SW
1 x	6.3 1/4	6.3 1/4	50 mm
1 x	6.3 1/4	6.3 1/4	100 mm
18 x	12.9 1/2		10 · 11 · 12 · 13 · 14 · 15 · 16 · 17 · 18 · 19 · 20 · 21 · 22 · 23 · 24 · 27 · 30 · 32 mm
2 x	12.9 1/2		16 · 21 mm
1 x	-	12.9 1/2	250 mm
1 x	12.9 1/2	12.9 1/2	75 mm
1 x	12.9 1/2	12.9 1/2	125 mm
1 x	12.9 1/2	12.9 1/2	250 mm
2 x	-		1.3 · 2 mm
1 x	-	6.3 1/4	150 mm
1 x	-	12.9 1/2	250 mm
1 x	6.3 1/4	6.3 1/4	25 mm

**V5103-L**, EAN 4047728051040

Weichschaum-Einlage · leer

**37,20 €**  
zzgl. MwSt.



**V5081**, EAN 4047728050814

Schraubendreher Satz



**126,- €**  
zzgl. MwSt.

XX	Ausführung	SW
9 x		T10 · T15 · T20 · T25 · T27 · T30 · T40 · T45 · T50
1 x		0.5x3 mm
9 x		1.5 · 2 · 2.5 · 3 · 4 · 5 · 6 · 8 · 10 mm
6 x		0.6x3 · 0.8x4 · 1x5.5 · 1.2x6.5 · 1.6x8 · 1.6x10 mm

XX	Ausführung	SW
4 x		PH0 · PH1 · PH2 · PH3
1 x		1x5.5 mm
1 x		PH2

**V5081-L**, EAN 4047728050821

Weichschaum-Einlage · leer

**37,20 €**  
zzgl. MwSt.

**V5085**, EAN 4047728050852

Hammer- und Meißel Satz



**174,50 €**  
zzgl. MwSt.

XX	Ausführung	SW
1 x		20 mm
1 x		32 mm
1 x		18 mm
1 x		Ø 4 mm
1 x		6 mm

XX	Ausführung	SW
6 x		Ø 2 · 3 · 4 · 5 · 6 · 8 mm
1 x		1500 g
1 x		800 g
1 x		Ø 32 mm

**V5085-L**, EAN 4047728050869

Weichschaum-Einlage · leer

**37,20 €**  
zzgl. MwSt.

**V5087**, EAN 4047728050876

VDE Werkzeug Satz



**234,- €**  
zzgl. MwSt.

XX	Ausführung	SW
1 x		0.5x3 mm
1 x		160 mm
1 x		160 mm
1 x		180 mm

XX	Ausführung	SW
1 x		200 mm
1 x		160 mm
4 x		0.5x3 · 0.8x4 · 1x5.5 · 1.2x6.5 mm
3 x		PH0 · PH1 · PH2

**V5087-L**, EAN 4047728050883

Weichschaum-Einlage · leer

**37,20 €**  
zzgl. MwSt.

# Weichschaum-Einlagen



**V4188**, EAN 4047728041881  
Steckschlüssel Werkzeug Satz



**294,- €**  
zzgl. MwSt.

XX	SW	Ausführung	SW	XX	SW	Ausführung	SW
5 x	6.3 1/4		R5 · R6 · R7 · R8 · R9	3 x	6.3 1/4		PH0 · PH1 · PH2
3 x	6.3 1/4		T5 · T6 · T7	3 x	6.3 1/4		PZ0 · PZ1 · PZ2
3 x	6.3 1/4		M5 · M6 · M8	7 x	6.3 1/4		T9 · T10 · T15 · T20 · T25 · T27 · T30
9 x	6.3 1/4		T7H · T10H · T15H · T20H · T25H · T27H · T30H · T40H · T45H	7 x	6.3 1/4		T9H · T10H · T15H · T20H · T25H · T27H · T30H
6 x	8 5/16		T40 · T45 · T50 · T55 · T60 · T70	6 x	10 3/8		E10 · E11 · E12 · E14 · E16 · E18
5 x	8 5/16		7 · 8 · 10 · 12 · 14 mm	6 x	10 3/8		10 · 11 · 12 · 13 · 14 · 15 mm
2 x	8 5/16		PH3 · PH4	10 x	10 3/8		10 · 11 · 12 · 13 · 14 · 15 · 16 · 17 · 18 · 19 mm
2 x	8 5/16		PZ3 · PZ4	17 x	12 1/2		10 · 11 · 12 · 13 · 14 · 15 · 16 · 17 · 18 · 19 · 20 · 21 · 22 · 24 · 27 · 30 · 32 mm
3 x	8 5/16		1.6x8-1.6x10-2x12 mm	5 x	12 1/2		16 · 17 · 18 · 19 · 22 mm
6 x	8 5/16		T40H · T45H · T50H · T55H · T60H · T70H	2 x	12 1/2		E20 · E24
2 x	-		1.3 · 2 mm	13 x	6.3 1/4		4 · 4.5 · 5 · 5.5 · 6 · 7 · 8 · 9 · 10 · 11 · 12 · 13 · 14 mm
1 x	10 3/8		28 mm	7 x	6.3 1/4		4 · 5 · 6 · 7 · 8 · 9 · 10 mm
1 x	12 1/2		37 mm	5 x	6.3 1/4		E4 · E5 · E6 · E7 · E8
1 x	-		150 mm	1 x	-	6.3 1/4	150 mm
1 x	6.3 1/4		110 mm	1 x	-	10 3/8	198 mm
1 x	-		43.7 mm	1 x	-	12 1/2	250 mm
4 x	6.3 1/4		3 · 4 · 5 · 6 mm	1 x	6.3 1/4	6.3 1/4	40 mm
4 x	6.3 1/4		0.8x4 · 1x5.5 · 1.2x6.5 · 1.2x7 mm	1 x	10 3/8	10 3/8	50 mm
				1 x	12 1/2	12 1/2	75 mm
				1 x	6.3 1/4	6.3 1/4	50 mm
				1 x	6.3 1/4	6.3 1/4	100 mm
				1 x	10 3/8	10 3/8	125 mm
				1 x	12 1/2	12 1/2	125 mm
				1 x	12 1/2	12 1/2	250 mm
				1 x	10 3/8		18 mm
				2 x	12 1/2		16 · 21 mm



**V4130**, EAN 4047728041300  
Weichschaum-Einlage · leer

**48,75 €**  
zzgl. MwSt.

**V5115**, EAN 4047728051293

Steckschlüssel Satz



**234,- €**  
zzgl. MwSt.

XX	■	Ausführung	SW	XX	■	Ausführung	SW
12 x	6.3 1/4		4 · 5 · 5.5 · 6 · 7 · 8 · 9 · 10 · 11 · 12 · 13 · 14 mm	1 x	12.5 1/2		250 mm
1 x	6.3 1/4		40 mm	1 x	-		250 mm
1 x	6.3 1/4		50 mm	1 x	-		43.7 mm
1 x	6.3 1/4		100 mm	1 x	6.3 1/4		25 mm
1 x	-		150 mm	1 x	6.3 1/4		26 mm
1 x	-		150 mm	1 x	10 3/8		27 mm
17 x	12.5 1/2		10 · 11 · 12 · 13 · 14 · 15 · 17 · 16 · 18 · 19 · 20 · 21 · 22 · 24 · 27 · 30 · 32 mm	1 x	10 3/8		36 mm
2 x	12.5 1/2		16 · 21 mm	1 x	12.5 1/2		36 mm
1 x	12.5 1/2		75 mm	1 x	12.5 1/2		46 mm
1 x	12.5 1/2		125 mm	1 x	20 3/4		50 mm
				5 x	6.3 1/4		32 x

**V5115-L**, EAN 4047728051811

Weichschaum-Einlage · leer

**48,75 €**  
zzgl. MwSt.

**V2837**, EAN 4047728028370

Steckschlüsseinsatz Satz

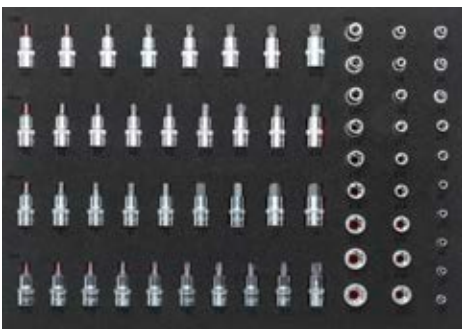

**246,- €**  
zzgl. MwSt.

XX	■	Ausführung	SW	XX	■	Ausführung	SW
7 x	6.3 1/4		E4 · E5 · E6 · E7 · E8 · E10 · E11	9 x	12.5 1/2		5 · 6 · 7 · 8 · 10 · 12 · 14 · 17 · 19 mm
12 x	10 3/8		E4 · E5 · E6 · E7 · E8 · E10 · E11 · E12 · E14 · E16 · E18 · E20	9 x	12.5 1/2		M5 · M6 · M7 · M8 · M9 · M10 · M12 · M13 · M14
9 x	12.5 1/2		E10 · E11 · E12 · E14 · E16 · E18 · E20 · E22 · E24	10 x	12.5 1/2		T20 · T25 · T27 · T30 · T40 · T45 · T50 · T55 · T60 · T70
8 x	12.5 1/2		M5 · M6 · M8 · M9 · M10 · M12 · M14 · M16				

**V2838**, EAN 4047728028387

Weichschaum-Einlage · leer

**48,75 €**  
zzgl. MwSt.

# Weichschaum-Einlagen



**V5109**, EAN 4047728051095  
Steckschlüssel Satz



XX	■	Ausführung	SW
16 x	20 3/4		19 · 21 · 22 · 23 · 24 · 26 · 27 · 28 · 30 · 32 · 34 · 36 · 38 · 41 · 46 · 50 mm
1 x	-	20 3/4	500 mm

XX	■	Ausführung	SW
1 x	20 3/4	20 3/4	200 mm
1 x	20 3/4	20 3/4	100 mm
1 x	20 3/4	20 3/4	400 mm
1 x	-	20 3/4	450 mm



**369,50 €**  
zzgl. MwSt.

**V5109-L**, EAN 4047728051101  
Weichschaum-Einlage · leer

**48,75 €**  
zzgl. MwSt.

**V4753**, EAN 4047728047531  
Schraubendreher-Einsatz Satz



XX	■	Ausführung	SW
9 x	125 1/2		M5 · M6 · M7 · M8 · M9 · M10 · M12 · M13 · M14
9 x	125 1/2		M5 · M6 · M7 · M8 · M9 · M10 · M12 · M13 · M14
10 x	125 1/2		T20 · T25 · T27 · T30 · T40 · T45 · T50 · T55 · T60 · T70
10 x	125 1/2		T20 · T25 · T27 · T30 · T40 · T45 · T50 · T55 · T60 · T70

XX	■	Ausführung	SW
7 x	125 1/2		M5 · M6 · M8 · M9 · M10 · M12 · M14
8 x	125 1/2		M5 · M6 · M8 · M9 · M10 · M14 · M16 · M12
8 x	125 1/2		5 · 6 · 7 · 8 · 10 · 11 · 12 · 13 mm
9 x	125 1/2		5 · 6 · 7 · 8 · 10 · 12 · 14 · 17 · 19 mm

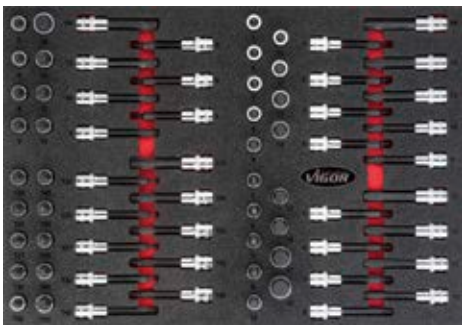

**310,50 €**  
zzgl. MwSt.

**V4752**, EAN 4047728047524  
Weichschaum-Einlage · leer

**48,75 €**  
zzgl. MwSt.

**V4727**, EAN 4047728047272  
Schraubendreher-Einsatz Satz



XX	■	Ausführung	SW
10 x	125 1/2		T20 · T25 · T27 · T30 · T40 · T45 · T50 · T55 · T60 · T70
10 x	125 1/2		T20 · T25 · T27 · T30 · T40 · T45 · T50 · T55 · T60 · T70
6 x	125 1/2		T40 · T45 · T50 · T55 · T60 · T70
6 x	125 1/2		T40 · T45 · T50 · T55 · T60 · T70

XX	■	Ausführung	SW
9 x	125 1/2		5 · 6 · 7 · 8 · 10 · 12 · 14 · 17 · 19 mm
8 x	125 1/2		5 · 6 · 7 · 8 · 10 · 11 · 12 · 13 mm
7 x	125 1/2		5 · 6 · 7 · 8 · 10 · 12 · 14 mm
6 x	125 1/2		5 · 6 · 7 · 8 · 10 · 12 mm



**286,50 €**  
zzgl. MwSt.

**V4726**, EAN 4047728047265  
Weichschaum-Einlage · leer

**48,75 €**  
zzgl. MwSt.



**V4729**, EAN 4047728**047296**  
Schraubendreher-Einsatz Satz

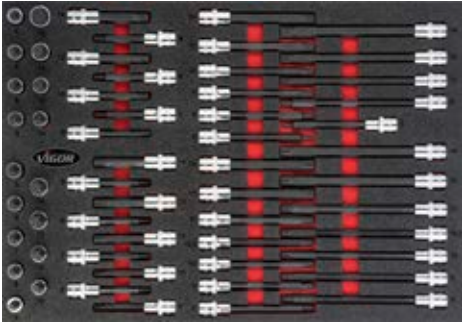

XX		Ausführung	SW
8 x			M5 · M6 · M8 · M9 · M10 · M12 · M14 · M16
7 x			M5 · M6 · M8 · M9 · M10 · M12 · M14
7 x			M5 · M6 · M8 · M9 · M10 · M12 · M14
4 x			M8 · M10 · M12 · M14

XX		Ausführung	SW
9 x			M5 · M6 · M7 · M8 · M9 · M10 · M12 · M13 · M14
9 x			M5 · M6 · M7 · M8 · M9 · M10 · M12 · M13 · M14
7 x			M8 · M9 · M10 · M10.3 · M12 · M13 · M14
7 x			M8 · M9 · M10 · M10.3 · M12 · M13 · M14

**291,50 €**  
zzgl. MwSt.

**V4728**, EAN 4047728**047289**  
Weichschaum-Einlage · leer

**48,75 €**  
zzgl. MwSt.

**V6726**, EAN 4047728**067515**  
Doppel-Maul-, Doppel-Ring- und Ring-Maulschlüssel Satz

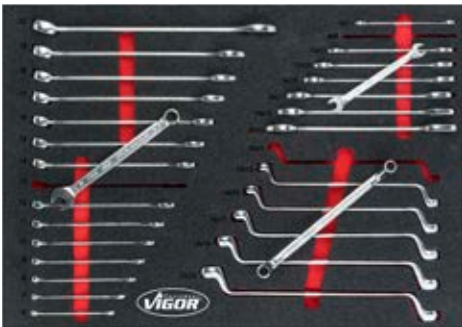

XX		Ausführung	SW
8 x			6x7 · 8x9 · 10x11 · 12x13 · 14x15 · 16x17 · 18x19 · 20x22 mm
15 x			6 · 7 · 8 · 9 · 10 · 11 · 12 · 13 · 14 · 15 · 16 · 17 · 18 · 19 · 22 mm

XX		Ausführung	SW
6 x			10x11 · 12x13 · 14x15 · 16x17 · 18x19 · 20x22 mm

**234,- €**  
zzgl. MwSt.

**V6726-L**, EAN 4047728**067263**  
Weichschaum-Einlage · leer

**48,75 €**  
zzgl. MwSt.

**V6643**, EAN 4047728**067430**  
Doppel-Ringschlüssel-, Doppel-Maulschlüssel-, Ring-Maulschlüssel Satz

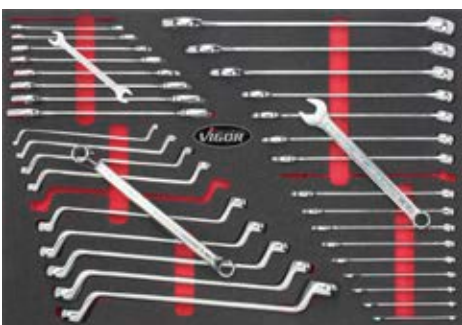

XX		Ausführung	SW
9 x			6x7 · 8x9 · 10x11 · 12x13 · 14x15 · 16x17 · 18x19 · 20x22 · 21x23 mm
17 x			6 · 7 · 8 · 9 · 10 · 11 · 12 · 13 · 14 · 15 · 16 · 17 · 18 · 19 · 22 · 24 · 27 mm

XX		Ausführung	SW
10 x			6x7 · 8x9 · 10x11 · 12x13 · 14x15 · 16x17 · 18x19 · 20x22 · 21x23 · 24x27 mm

**299,- €**  
zzgl. MwSt.

**V6643-L**, EAN 4047728**066433**  
Weichschaum-Einlage · leer

**48,75 €**  
zzgl. MwSt.

# Weichschaum-Einlagen



**V6724**, EAN 4047728067492

Doppel-Maulschlüssel-, Ring-Maulschlüssel-,  
Ratschen Ring-Maulschlüssel Satz



XX	Ausführung	SW
12 x		8 · 9 · 10 · 11 · 12 · 13 · 14 · 15 · 16 · 17 · 18 · 19 mm
12 x		6 x 7 · 8 x 9 · 10 x 11 · 12 x 13 · 14 x 15 · 16 x 17 · 18 x 19 · 20 x 22 · 21 x 23 · 24 x 27 · 25 x 28 · 30 x 32 mm

XX	Ausführung	SW
21 x		6 · 7 · 8 · 9 · 10 · 11 · 12 · 13 · 14 · 15 · 16 · 17 · 18 · 19 · 20 · 21 · 22 · 24 · 27 · 30 · 32 mm



**385,50 €**  
zzgl. MwSt.

**V6724-L**, EAN 4047728067249

Weichschaum-Einlage · leer

**37,20 €**  
zzgl. MwSt.

**V4230**, EAN 4047728042307

Schraubendreher Satz



XX	Ausführung	SW
6 x		6 · 7 · 8 · 10 · 12 · 13 mm
6 x		0.6x3 · 0.8x4 · 1x5.5 · 1.2x6.5 · 1.6x8 · 1.6x10 mm
4 x		PH0 · PH1 · PH2 · PH3
1 x		1x5.5 mm
1 x		PH2

XX	Ausführung	SW
7 x		T10 · T15 · T20 · T25 · T27 · T30 · T40
1 x		0.5x3 mm
2 x		PH1 · PH2
4 x		0.6x3.5 · 1x4.5 · 1x5.5 · 1.2x6.5 mm



**204,50 €**  
zzgl. MwSt.

**V4231**, EAN 4047728042314

Weichschaum-Einlage · leer

**48,75 €**  
zzgl. MwSt.

**V5175**, EAN 4047728051750

T-Griff Schraubendreher und  
Winkelschraubendreher Satz



XX	Ausführung	SW
9 x		1,5 · 2 · 2,5 · 3 · 4 · 5 · 6 · 8 · 10 mm
9 x		T10 · T15 · T20 · T25 · T27 · T30 · T40 · T45 · T50

XX	Ausführung	SW
8 x		2 · 2.5 · 3 · 4 · 5 · 6 · 8 · 10 mm
8 x		T9 · T10 · T15 · T20 · T25 · T27 · T30 · T40



**160,- €**  
zzgl. MwSt.

**V5175-L**, EAN 4047728051767

Weichschaum-Einlage · leer

**48,75 €**  
zzgl. MwSt.



**V6821**, EAN 4047728068222

Steckschlüssel Satz

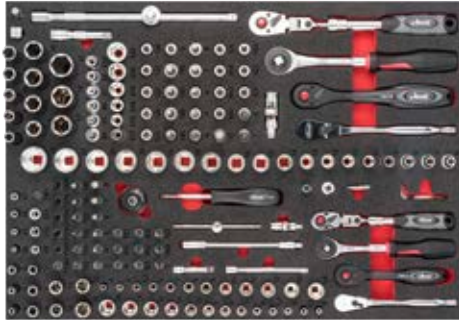

**562,50 €**  
zzgl. MwSt.

XX	■	Ausführung	SW	XX	■	Ausführung	SW
12 x	10 3/8		E4 · E5 · E6 · E7 · E8 · E10 · E11 · E12 · E14 · E16 · E18 · E20	13 x	6.3 1/4		4 · 4.5 · 5 · 5.5 · 6 · 7 · 8 · 9 · 10 · 11 · 12 · 13 · 14 mm
18 x	10 3/8		6 · 7 · 8 · 9 · 10 · 11 · 12 · 13 · 14 · 15 · 16 · 17 · 18 · 19 · 20 · 21 · 22 · 24 mm	6 x	6.3 1/4		T10 · T15 · T20 · T25 · T30 · T40
10 x	10 3/8		8 · 9 · 10 · 11 · 12 · 13 · 14 · 15 · 17 · 19 mm	7 x	6.3 1/4		T9H · T10H · T15H · T20H · T25H · T27H · T30H
2 x	10 3/8		16 · 21 mm	6 x	6.3 1/4		3 · 4 · 5 · 6 · 7 · 8 mm
9 x	10 3/8		T15 · T20 · T25 · T27 · T30 · T40 · T45 · T50 · T55	3 x	6.3 1/4		PH1 · PH2 · PH3
7 x	10 3/8		3 · 4 · 5 · 6 · 7 · 8 · 10 mm	3 x	6.3 1/4		PZ1 · PZ2 · PZ3
3 x	10 3/8		PH1 · PH2 · PH3	3 x	6.3 1/4		0.8x4-1x5.5 · 1.2x6.5 mm
3 x	10 3/8		PZ1 · PZ2 · PZ3	1 x	6.3 1/4	10 3/8	26 mm
3 x	10 3/8		0.8x5.5-1x7 · 1.2x8 mm	1 x	-	10 3/8	198 mm
1 x	10 3/8	10 3/8	250 mm	1 x	-	10 3/8	198 mm
1 x	10 3/8	10 3/8	50 mm	1 x	-	10 3/8	237 mm
1 x	10 3/8	10 3/8	75 mm	1 x	-	6.3 1/4	150 mm
1 x	10 3/8	12.5 1/2	36 mm	1 x	6.3 1/4	6.3 1/4	110 mm
1 x	10 3/8	6.3 1/4	27 mm	1 x	6.3 1/4	6.3 1/4	40 mm
1 x	12.5 1/2	10 3/8	40 mm	1 x	-	6.3 1/4	150 mm
7 x	6.3 1/4		E4 · E5 · E6 · E7 · E8 · E10 · E11	1 x	-	6.3 1/4	150 mm
11 x	6.3 1/4		4 · 5 · 6 · 7 · 8 · 9 · 10 · 11 · 12 · 13 · 14 mm	1 x	-	6.3 1/4	176 mm
10 x	6.3 1/4		4 · 5 · 6 · 7 · 8 · 9 · 10 · 11 · 12 · 13 mm	1 x	-	6.3 1/4	29 mm
				1 x	8 5/16	10 3/8	30 mm
				1 x	6.3 1/4	6.3 1/4	25 mm

**V6821-L**, EAN 4047728068055

Weichschaum-Einlage · leer

**48,75 €**  
zzgl. MwSt.

**V6822**, EAN 4047728068284

Steckschlüssel Satz

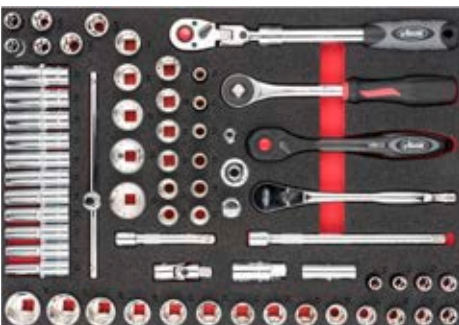

**478,50 €**  
zzgl. MwSt.

XX	■	Ausführung	SW	XX	■	Ausführung	SW
6 x	12.5 1/2		E14 · E16 · E18 · E20 · E22 · E24	1 x	12.5 1/2	10 3/8	36 mm
18 x	12.5 1/2		10 · 11 · 12 · 13 · 14 · 15 · 16 · 17 · 18 · 19 · 20 · 21 · 22 · 23 · 24 · 27 · 30 · 32 mm	1 x	12.5 1/2	12.5 1/2	75 mm
11 x	12.5 1/2		10 · 11 · 12 · 13 · 14 · 15 · 16 · 17 · 18 · 19 · 22 mm	1 x	12.5 1/2	12.5 1/2	125 mm
2 x	12.5 1/2		16 · 21 mm	1 x	12.5 1/2	12.5 1/2	250 mm
17 x	12.5 1/2		10 · 11 · 12 · 13 · 14 · 15 · 16 · 17 · 18 · 19 · 20 · 21 · 22 · 24 · 27 · 30 · 32 mm	1 x	12.5 1/2	20 3/4	46 mm
				1 x	20 3/4	12.5 1/2	50 mm
				1 x	-	12.5 1/2	288 mm
				1 x	-	12.5 1/2	250 mm
				1 x	-	12.5 1/2	250 mm
				1 x	-	12.5 1/2	250 mm

**V6822-L**, EAN 4047728068062

Weichschaum-Einlage · leer

**48,75 €**  
zzgl. MwSt.



# Weichschaum-Einlagen



**V6809**, EAN 4047728068307  
Schraubendreher-Einsatz Satz

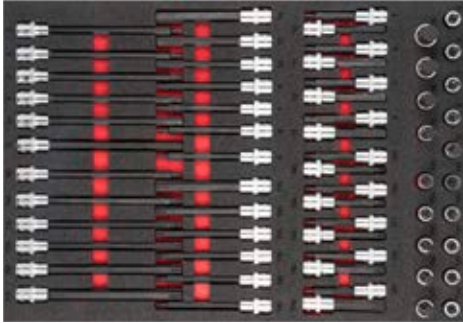

**286,50 €**  
zzgl. MwSt.

XX	■	Ausführung	SW
10 x	129 1/2		T20 · T25 · T27 · T30 · T40 · T45 · T50 · T55 · T60 · T70
10 x	129 1/2		T20 · T25 · T27 · T30 · T40 · T45 · T50 · T55 · T60 · T70
6 x	129 1/2		T40 · T45 · T50 · T55 · T60 · T70
6 x	129 1/2		T40 · T45 · T50 · T55 · T60 · T70

XX	■	Ausführung	SW
9 x	129 1/2		5 · 6 · 7 · 8 · 10 · 12 · 14 · 17 · 19 mm
8 x	129 1/2		5 · 6 · 7 · 8 · 10 · 11 · 12 · 13 mm
7 x	129 1/2		5 · 6 · 7 · 8 · 10 · 12 · 14 mm
6 x	129 1/2		5 · 6 · 7 · 8 · 10 · 12 mm

**V6809-L**, EAN 4047728068093  
Weichschaum-Einlage · leer

**48,75 €**  
zzgl. MwSt.

**V6810**, EAN 4047728068413  
Schraubendreher-Einsatz Satz

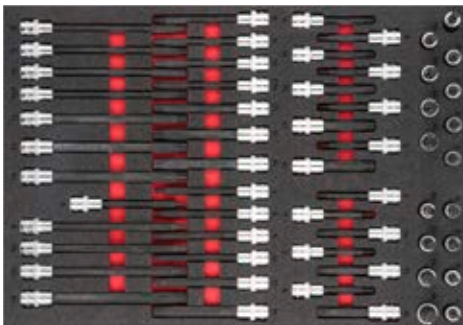

**291,50 €**  
zzgl. MwSt.

XX	■	Ausführung	SW
9 x	129 1/2		M5 · M6 · M7 · M8 · M9 · M10 · M12 · M13 · M14
9 x	129 1/2		M5 · M6 · M7 · M8 · M9 · M10 · M12 · M13 · M14
7 x	129 1/2		M8 · M9 · M10 · M10.3 · M12 · M13 · M14
7 x	129 1/2		M8 · M9 · M10 · M10.3 · M12 · M13 · M14

XX	■	Ausführung	SW
8 x	129 1/2		M5 · M6 · M8 · M9 · M10 · M12 · M14 · M16
7 x	129 1/2		M5 · M6 · M8 · M9 · M10 · M12 · M14
7 x	129 1/2		M5 · M6 · M8 · M10 · M12 · M14 · M9
4 x	129 1/2		M8 · M10 · M12 · M14

**V6810-L**, EAN 4047728068109  
Weichschaum-Einlage · leer

**48,75 €**  
zzgl. MwSt.

**V6807**, EAN 4047728068277  
Ratschen Ring-Maulschlüssel Satz



**641,50 €**  
zzgl. MwSt.

XX	Ausführung	SW
18 x		8 · 9 · 10 · 11 · 12 · 13 · 14 · 15 · 16 · 17 · 18 · 19 · 21 · 22 · 24 · 27 · 30 · 32 mm

XX	Ausführung	SW
22 x		6 · 7 · 8 · 9 · 10 · 11 · 12 · 14 · 13 · 15 · 16 · 17 · 18 · 19 · 20 · 21 · 22 · 24 · 27 · 30 · 32 · 36 mm

**V6807-L**, EAN 4047728068079  
Weichschaum-Einlage · leer

**48,75 €**  
zzgl. MwSt.



**V6808**, EAN 4047728068291

Doppel-Ring- und Maulschlüssel Satz

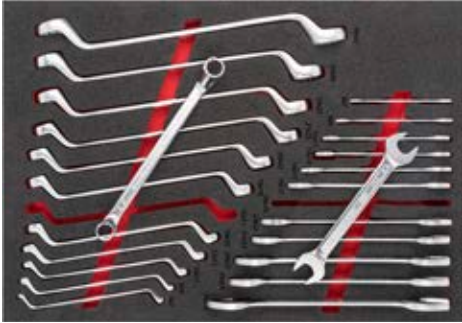

XX	Ausführung	SW
12 x		6x7 · 8x9 · 10x11 · 12x13 · 14x15 · 16x17 · 18x19 · 20x22 · 21x23 · 24x27 · 25x28 · 30x32 mm

XX	Ausführung	SW
12 x		6x7 · 8x9 · 10x11 · 12x13 · 14x15 · 16x17 · 18x19 · 20x22 · 21x23 · 24x27 · 25x28 · 30x32 mm

**239,- €**  
zzgl. MwSt.

**V6808-L**, EAN 4047728068086

Weichschaum-Einlage · leer

**48,75 €**  
zzgl. MwSt.

**V6813**, EAN 4047728068444

Schraubendreher Satz

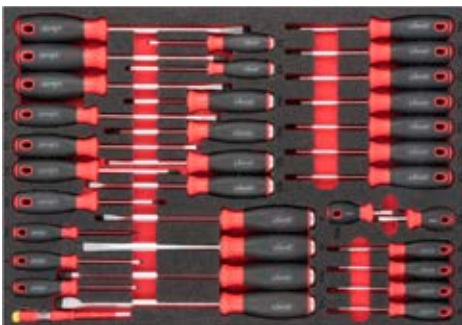

XX	Ausführung	SW
6 x		0,6 x 3 · 0,8 x 4 · 1 x 5,5 · 1,2 x 6,5 · 1,6 x 8 · 1,6 x 10 mm
4 x		PH0 · PH1 · PH2 · PH3
1 x		1 x 5,5 mm
1 x		PH2

XX	Ausführung	SW
7 x		0,6x3,5-1x4,5-1x5,5- 1,2x6,5 · 1,6x8 · 1,6x10 · 2x12 mm
3 x		PH1 · PH2 · PH3
11 x		T6 · T7 · T8 · T9 · T10 · T15 · T20 · T25 · T27 · T30 · T40
1 x		0,5x3 mm

**202,50 €**  
zzgl. MwSt.

**V6813-L**, EAN 4047728068130

Weichschaum-Einlage · leer

**48,75 €**  
zzgl. MwSt.

**V6814**, EAN 4047728068451

Schraubendreher- und Bit Satz



XX	Ausführung	SW
4 x		1,6 · 2 · 2,4 · 3 mm
2 x		PH0 · PH00
1 x		260 mm
1 x		260 mm
1 x		260 mm
1 x		260 mm
1 x		260 mm
1 x		260 mm
1 x		130 mm
1 x		130 mm
1 x		130 mm
1 x		130 mm

XX	Ausführung	SW
5 x		32 x
5 x		22 x
3 x		6 · 7 · 8 mm
9 x		T10 · T15 · T20 · T25 · T27 · T30 · T40 · T45 · T50
9 x		1,5 · 2 · 2,5 · 3 · 4 · 5 · 6 · 8 · 10 mm
6 x		6 · 7 · 8 · 10 · 12 · 13 mm

**275,- €**  
zzgl. MwSt.

**V6814-L**, EAN 4047728068147

Weichschaum-Einlage · leer

**48,75 €**  
zzgl. MwSt.

# Weichschaum-Einlagen



**V6817**, EAN 4047728068499

Hammer-, Meißel- und Splintreiber Satz



**347,- €**  
zzgl. MwSt.

XX	Ausführung	SW
1 x		800 g
1 x		1500 g
1 x		Ø 32 mm
1 x		645 mm
1 x		10 x
1 x		210 mm
1 x		10 x
1 x		90 mm

XX	Ausführung	SW
1 x		-
6 x		Ø 3 · 4 · 5 · 6 · 8 · 2 mm
1 x		6 mm
1 x		18 mm
1 x		Ø 4 mm
2 x		190 · 170 mm
2 x		Ø 4 · 40 mm
4 x		10 · 16 · 20 · 29 mm
7 x		Ø 2 · 3 · 4 · 5 · 6 · 7 · 8 mm

**V6817-L**, EAN 4047728068178

Weichschaum-Einlage · leer

**48,75 €**  
zzgl. MwSt.

**V6818**, EAN 4047728068482

Schaber- und Lösehebel Satz



**202,50 €**  
zzgl. MwSt.

XX	Ausführung	SW
1 x		165 mm
1 x		5 x
1 x		490 mm
1 x		16 x

XX	Ausführung	SW
1 x		22 mm
1 x		10 x
1 x		4 x
1 x		40 mm

**V6818-L**, EAN 4047728068185

Weichschaum-Einlage · leer

**48,75 €**  
zzgl. MwSt.

**V6811**, EAN 4047728068420

Schlagschrauber Steckschlüsseinsatz Satz



**802,50 €**  
zzgl. MwSt.

XX	Ausführung	SW
1 x		-
1 x		-
1 x		-
5 x		15 · 17 · 19 · 21 · 22 mm
1 x		17 mm
1 x		19 mm
13 x		10 · 11 · 12 · 13 · 14 · 15 · 16 · 17 · 18 · 19 · 21 · 22 · 24 mm

XX	Ausführung	SW
13 x		10 · 11 · 12 · 13 · 14 · 15 · 16 · 17 · 18 · 19 · 21 · 22 · 24 mm
8 x		T30 · T40 · T45 · T50 · T55 · T60 · T70 · T80
8 x		M5 · M6 · M8 · M10 · M12 · M14 · M16 · M18
8 x		5 · 6 · 8 · 10 · 12 · 14 · 17 · 19 mm
1 x		17 mm
4 x		24 · 30 · 32 · 36 mm

**V6811-L**, EAN 4047728068116

Weichschaum-Einlage · leer

**48,75 €**  
zzgl. MwSt.



**V6812**, EAN 4047728**068437**

Räder / Reifen Werkzeug



**478,50 €**  
zzgl. MwSt.

XX		Ausführung	SW
1 x	-		-
1 x	-		-
1 x	-		9 mm
1 x	-		500 mm
1 x	-		-

XX		Ausführung	SW
1 x	-		128 mm
1 x	-		4 x
1 x	125 1/2		118 mm
1 x	-		250 mm
1 x	125 1/2		540 mm

**V6812-L**, EAN 4047728**068123**

Weichschaum-Einlage · leer

**48,75 €**  
zzgl. MwSt.

**V5111N**, EAN 4047728**078733**

Schraubendreher · Zangen Satz



**210,- €**  
zzgl. MwSt.

XX		Ausführung	SW
1 x			300 g
1 x			160 mm
6 x			Ø 2 · 3 · 4 · 5 · 6 · 8 mm
1 x			Ø 4 mm
1 x			0,05 – 1,00 mm

XX		Ausführung	SW
2 x			0,6 x 3 – 1,2 x 6,5 · PH0 – PH2
1 x			250 mm
1 x			200 mm
9 x			T10 · T15 · T20 · T25 · T27 · T30 · T40 · T45 · T50
9 x			1,5 · 2 · 2,5 · 3 · 4 · 5 · 6 · 8 · 10 mm

**V5111N-L**, EAN 4047728**077996**

Weichschaum-Einlage · leer

**48,75 €**  
zzgl. MwSt.

**V5634N**, EAN 4047728**078757**

Hammer Zangen Schraubendreher Satz



**204,50 €**  
zzgl. MwSt.

XX		Ausführung	SW
1 x	-		-
1 x	-		250 mm
1 x	-		300 g
1 x	-		Ø 32 mm
1 x	-		160 mm

XX		Ausführung	SW
1 x	-		200 mm
1 x	-		Ø 4 mm
6 x	-		Ø 2 · 3 · 4 · 5 · 6 · 8 mm
1 x	-		0,05 – 1,00 mm
2 x			0,6 x 3 – 1,2 x 6,5 · PH0 – PH2

**V5634N-L**, EAN 4047728**078016**

Weichschaum-Einlage · leer

**48,75 €**  
zzgl. MwSt.

# Weichschaum-Einlagen



**V5636N**, EAN 4047728078764  
Zangen · Hammer Satz



**369,50 €**  
zzgl. MwSt.

XX	Ausführung	SW
1 x		40 mm
1 x		340 mm
1 x		200 mm
1 x		180 mm
1 x		160 mm

XX	Ausführung	SW
3 x		230 · 180 · 140 mm
3 x		230 · 140 · 180 mm
1 x		Ø 40 mm
1 x		800 g
1 x		22 mm
1 x		10 x
1 x		250 mm

**V5636N-L**, EAN 4047728078030  
Weichschaum-Einlage · leer

**48,75 €**  
zzgl. MwSt.

**V5637N**, EAN 4047728078771  
Zangen, Hammer · Meißel Satz



**308,50 €**  
zzgl. MwSt.

XX	Ausführung	SW
1 x		0,05 – 1,00 mm
1 x		180 mm
1 x		180 mm
1 x		180 mm
1 x		180 mm
1 x		180 mm
1 x		Ø 4 mm
6 x		Ø 2 · 3 · 4 · 5 · 6 · 8 mm

XX	Ausführung	SW
1 x		18 mm
1 x		6 mm
1 x		180 mm
1 x		160 mm
1 x		Ø 32 mm
1 x		300 g
1 x		22 mm
1 x		250 mm
1 x		-

**V5637N-L**, EAN 4047728078047  
Weichschaum-Einlage · leer

**48,75 €**  
zzgl. MwSt.

**V6815N**, EAN 4047728078795  
Zangen Satz



**418,50 €**  
zzgl. MwSt.

XX	Ausführung	SW
1 x		115 mm
1 x		180 mm
1 x		160 mm
1 x		200 mm
1 x		250 mm
1 x		290 mm

XX	Ausführung	SW
1 x		300 mm
1 x		340 mm
1 x		340 mm
1 x		335 mm
1 x		345 mm
1 x		345 mm

**V6815N-L**, EAN 4047728078061  
Weichschaum-Einlage · leer

**48,75 €**  
zzgl. MwSt.



**V4586**, EAN 4047728045865

Steckschlüssel Werkzeug Satz für Series XL



**456,- €**  
zzgl. MwSt.

XX	SW	Ausführung	SW	XX	SW	Ausführung	SW
5 x	6.3 1/4	+	R5 · R6 · R7 · R8 · R9	4 x	6.3 1/4	○	3 · 4 · 5 · 6 mm
3 x	6.3 1/4	+	T5 · T6 · T7	3 x	6.3 1/4	+	PH0 · PH1 · PH2
3 x	6.3 1/4	○	M5 · M6 · M8	3 x	6.3 1/4	+	PZ0 · PZ1 · PZ2
9 x	6.3 1/4	+	T7H · T10H · T15H · T20H · T25H · T27H · T30H · T40H · T45H	4 x	6.3 1/4	○	0.8x4 · 1x5.5 · 1.2x6.5 · 1.2x7 mm
6 x	8 9/16	+	T40 · T45 · T50 · T55 · T60 · T70	7 x	6.3 1/4	+	T9H · T10H · T15H · T20H · T25H · T27H · T30H
5 x	8 9/16	○	7 · 8 · 10 · 12 · 14 mm	10 x	10 3/8	○	10 · 11 · 12 · 13 · 14 · 15 · 16 · 17 · 18 · 19 mm
2 x	8 9/16	+	PH3 · PH4	6 x	10 3/8	○	10 · 11 · 12 · 13 · 14 · 15 mm
2 x	8 9/16	+	PZ3 · PZ4	6 x	10 3/8	+	E10 · E11 · E12 · E14 · E16 · E18
3 x	8 9/16	○	1.6x8 · 1.6x10 · 2 x 12 mm	6 x	10 3/8	+	10 · 11 · 12 · 13 · 14 · 15 mm
6 x	8 9/16	+	T40H · T45H · T50H · T55H · T60H · T70H	17 x	12 1/2	○	10 · 11 · 12 · 13 · 14 · 15 · 16 · 17 · 18 · 19 · 20 · 21 · 22 · 24 · 27 · 30 · 32 mm
2 x	-	○	1.3 · 2 mm	5 x	12 1/2	○	16 · 17 · 18 · 19 · 22 mm
1 x	10 3/8	8 9/16	28 mm	2 x	12 1/2	+	E20 · E24
1 x	6.3 1/4	6.3 1/4	25 mm	13 x	6.3 1/4	○	4 · 4.5 · 5 · 5.5 · 6 · 7 · 8 · 9 · 10 · 11 · 12 · 13 · 14 mm
1 x	12 1/2	8 9/16	37 mm	7 x	6.3 1/4	○	4 · 5 · 6 · 7 · 8 · 9 · 10 mm
1 x	6.3 1/4	6.3 1/4	25 mm	5 x	6.3 1/4	+	E4 · E5 · E6 · E7 · E8
1 x	6.3 1/4	6.3 1/4	110 mm	1 x	-	6.3 1/4	150 mm
1 x	-	6.3 1/4	150 mm	1 x	-	10 3/8	198 mm
1 x	-	12 1/2	43.7 mm	1 x	-	12 1/2	250 mm
8 x	12 1/2	+	T20 · T25 · T27 · T30 · T40 · T45 · T50 · T55	1 x	6.3 1/4	6.3 1/4	40 mm
8 x	12 1/2	+	T27 · T30 · T40 · T45 · T50 · T55 · T60 · T70	1 x	10 3/8	10 3/8	50 mm
8 x	12 1/2	○	M5 · M6 · M8 · M9 · M10 · M14 · M16 · M12	1 x	12 1/2	12 1/2	75 mm
7 x	12 1/2	○	M5 · M6 · M8 · M9 · M10 · M12 · M14	1 x	6.3 1/4	6.3 1/4	50 mm
8 x	12 1/2	○	5 · 6 · 7 · 8 · 10 · 12 · 14 · 17 mm	1 x	6.3 1/4	6.3 1/4	100 mm
8 x	12 1/2	○	5 · 6 · 7 · 8 · 10 · 11 · 12 · 13 mm	1 x	10 3/8	10 3/8	125 mm
7 x	6.3 1/4	+	T9 · T10 · T15 · T20 · T25 · T27 · T30	1 x	12 1/2	12 1/2	125 mm
				1 x	12 1/2	12 1/2	250 mm
				1 x	10 3/8	○	18 mm
				2 x	12 1/2	○	16 · 21 mm

**V4521**, EAN 4047728045216

Weichschaum-Einlage · leer

**60,30 €**  
zzgl. MwSt.

**V6831**, EAN 4047728082280

Drehmomentschlüssel Einlage inkl. 40-200 Nm Drehmomentschlüssel



**166,- €**  
zzgl. MwSt.

XX	SW	Ausführung	SW
1 x	12 1/2	○	540 mm



**V6831-L**, EAN 4047728082242

Weichschaum-Einlage · leer

**19,90 €**  
zzgl. MwSt.

# Weichschaum-Einlagen



**V6650**, EAN 4047728067454

Ring-Maul-, Doppelring-,  
Doppelmaulschlüssel Satz für Series XL



XX	Ausführung	SW
12 x		6 x 7 · 8 x 9 · 10 x 11 · 12 x 13 · 14 x 15 · 16 x 17 · 18 x 19 · 20 x 22 · 21 x 23 · 24 x 27 · 25 x 28 · 30 x 32 mm
12 x		6 x 7 · 8 x 9 · 10 x 11 · 12 x 13 · 14 x 15 · 16 x 17 · 18 x 19 · 20 x 22 · 21 x 23 · 24 x 27 · 25 x 28 · 30 x 32 mm

XX	Ausführung	SW
12 x		8 · 9 · 10 · 11 · 12 · 13 · 14 · 15 · 16 · 17 · 18 · 19 mm
22 x		6 · 7 · 8 · 9 · 10 · 11 · 12 · 13 · 14 · 15 · 16 · 17 · 18 · 19 · 20 · 21 · 22 · 24 · 27 · 30 · 32 · 36 mm



**478,50 €**  
zzgl. MwSt.

**V6650-L**, EAN 4047728066501

Weichschaum-Einlage · leer

**60,30 €**  
zzgl. MwSt.

**V5170**, EAN 4047728051712

Schraubendreher Satz für Series XL



XX	Ausführung	SW
4 x		1.6 · 2 · 2.4 · 3 mm
2 x		PH0 · PH00
11 x		T6 · T7 · T8 · T9 · T10 · T15 · T20 · T25 · T27 · T30 · T40
4 x		PH0 · PH1 · PH2 · PH3
3 x		PH1 · PH2 · PH3
1 x		PH2
5 x		0.6 x 3 · 0.8 x 4 · 1 x 5.5 · 1.6 x 8 · 1.6 x 10 mm

XX	Ausführung	SW
4 x		0.6 x 3.5 · 1 x 4.5 · 1 x 5.5 · 1.2 x 6.5 mm
1 x		1 x 5.5 mm
9 x		T10 · T15 · T20 · T25 · T27 · T30 · T40 · T45 · T50
9 x		1.5 · 2 · 2.5 · 3 · 4 · 5 · 6 · 8 · 10 mm
6 x		6 · 7 · 8 · 10 · 12 · 13 mm
1 x		0.5 x 3 mm



**246,- €**  
zzgl. MwSt.

**V5170-L**, EAN 4047728051729

Weichschaum-Einlage · leer

**60,30 €**  
zzgl. MwSt.

**V5638N**, EAN 4047728078788

Zangen · Hammer · Meißel Satz für Series XL



XX	Ausführung	SW
1 x		1000 g
1 x		∅ 32 mm
1 x		22 mm
6 x		∅ 2 · 3 · 4 · 5 · 6 · 8 mm
1 x		∅ 4 mm
1 x		18 mm
1 x		6 mm
1 x		40 mm
1 x		10 x
1 x		150 mm

XX	Ausführung	SW
1 x		335 mm
1 x		340 mm
1 x		1500 g
1 x		165 mm
1 x		160 mm
1 x		180 mm
1 x		200 mm
1 x		250 mm
3 x		140 · 180 · 230 mm
3 x		140 · 180 · 230 mm



**478,50 €**  
zzgl. MwSt.

**V5638N-L**, EAN 4047728078054

Weichschaum-Einlage · leer

**60,30 €**  
zzgl. MwSt.

**V6015**, EAN 4047728074667

Schlagschrauber · Steckschlüssel  
Satz für Series XL



**833,50 €**  
zzgl. MwSt.

XX	Ausführung	SW
1 x	122½	19 mm
1 x	122½	17 mm
1 x	- 122½	540 mm
1 x	- 122½	118 mm
13 x	122½	10 · 11 · 12 · 13 · 14 · 15 · 16 · 17 · 18 · 19 · 21 · 22 · 24 mm

XX	Ausführung	SW
13 x	122½	10 · 11 · 12 · 13 · 14 · 15 · 16 · 17 · 18 · 19 · 21 · 22 · 24 mm
5 x	122½	15 · 17 · 19 · 21 · 22 mm
8 x	122½	5 · 6 · 8 · 10 · 12 · 14 · 17 · 19 mm
8 x	122½	M5 · M6 · M8 · M10 · M12 · M14 · M16 · M18
8 x	122½	T30 · T40 · T45 · T50 · T55 · T60 · T70 · T80

**V6015-L**, EAN 4047728074056

Weichschaum-Einlage · leer

**60,30 €**  
zzgl. MwSt.

**V7015N**, EAN 4047728078818

Zangen · Schaber Satz für Series XL



**478,50 €**  
zzgl. MwSt.

XX	Ausführung	SW
1 x		800 g
1 x		300 mm
1 x		335 mm
1 x		340 mm
1 x		10 x
1 x		90 mm
1 x		165 mm
1 x		290 mm

XX	Ausführung	SW
1 x		16 x
7 x		Ø 2 · 3 · 4 · 5 · 6 · 7 · 8 mm
2 x		Ø 4 · 40 mm
4 x		10 · 16 · 20 · 29 mm
2 x		170 · 190 mm
1 x		180 mm
1 x		200 mm
1 x		250 mm

**V7015N-L**, EAN 4047728078085

Weichschaum-Einlage · leer

**60,30 €**  
zzgl. MwSt.

**V6816N**, EAN 4047728078801

Zangen Satz

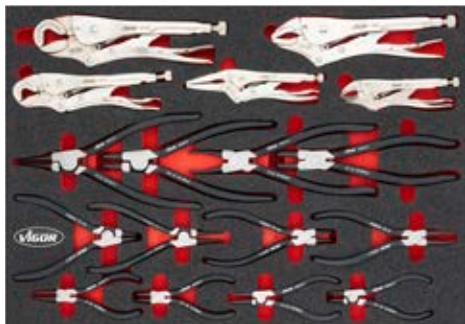

**430,50 €**  
zzgl. MwSt.

XX	Ausführung	SW
1 x		150 mm
1 x		250 mm
1 x		125 mm
1 x		11 – 19 mm
1 x		16 – 27 mm

XX	Ausführung	SW
3 x		140 · 180 · 230 mm
3 x		140 · 180 · 230 mm
3 x		140 · 180 · 230 mm
3 x		140 · 180 · 230 mm

**V6816N-L**, EAN 4047728078078

Weichschaum-Einlage · leer

**48,75 €**  
zzgl. MwSt.



# Weichschaum-Einlagen



**V5009**, EAN 4047728050098  
2-Komponenten Weichschaum-Einlage · mit Leerfach

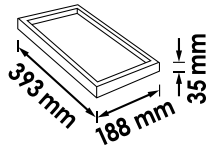

**26,75 €**  
zzgl. MwSt.

**V4631**, EAN 4047728046312  
2-Komponenten Weichschaum-Einlage · ohne Ausfräsung

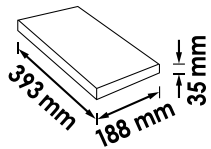

**13,55 €**  
zzgl. MwSt.

**V5018**, EAN 4047728050180  
2-Komponenten Weichschaum-Einlage · mit Leerfach

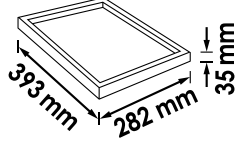

**37,20 €**  
zzgl. MwSt.

**V4632**, EAN 4047728046329  
2-Komponenten Weichschaum-Einlage · ohne Ausfräsung

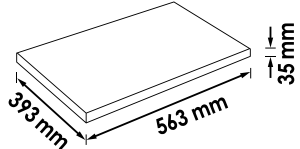

**27,15 €**  
zzgl. MwSt.

**V4633**, EAN 4047728064347  
2-Komponenten Weichschaum-Einlage · ohne Ausfräsung

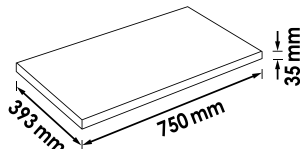

**31,35 €**  
zzgl. MwSt.



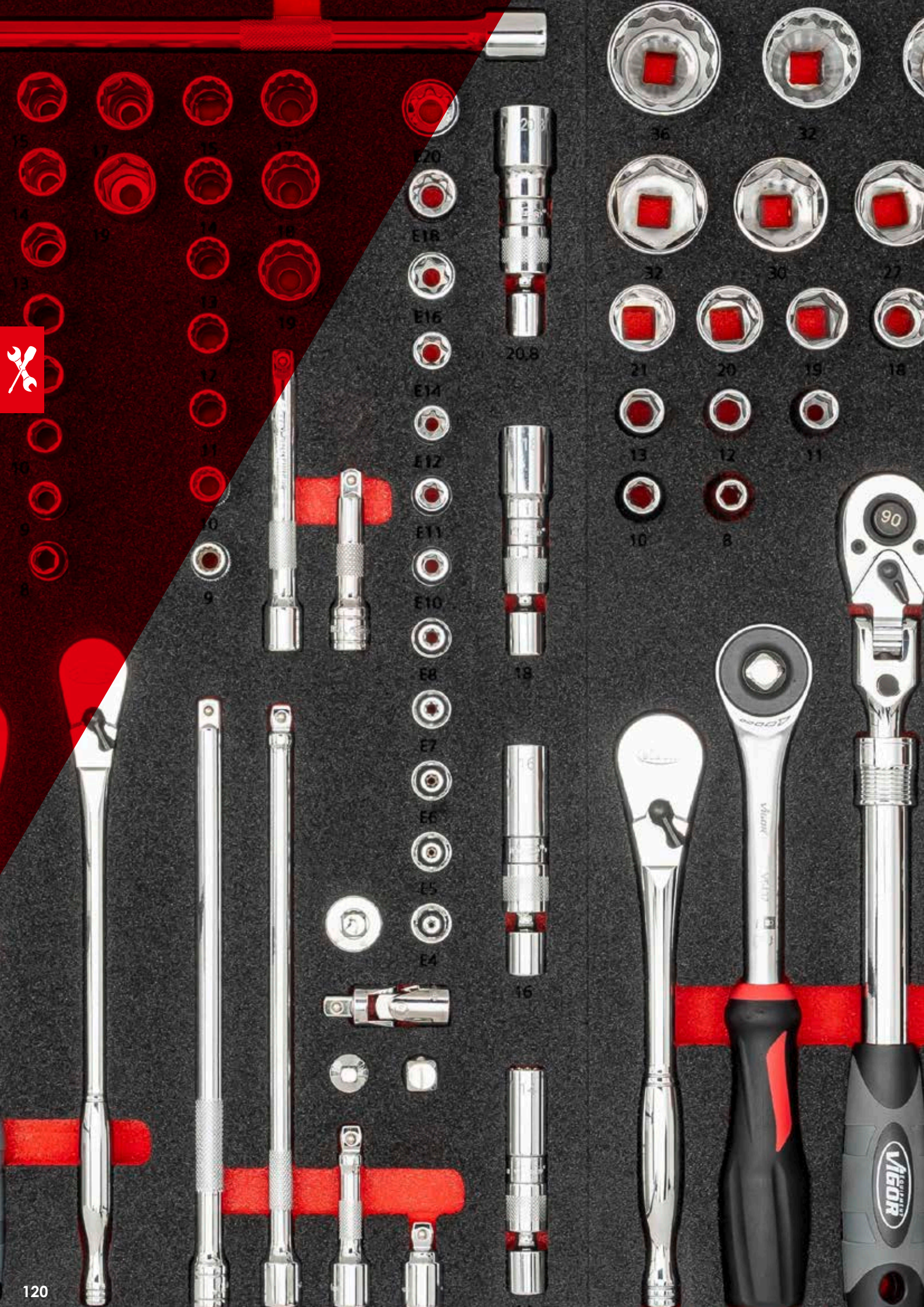

- 5
- 6
- 7
- 8
- 9
- 10
- 11
- 12
- 13
- 14
- 15
- 16
- 17
- 18
- 19
- 20

- E20
- E18
- E16
- E14
- E12
- E11
- E10
- E8
- E7
- E6
- E5
- E4

- 36
- 32
- 32
- 30
- 27
- 21
- 20
- 19
- 18
- 13
- 12
- 11
- 10
- 8

# Handwerkzeuge

Steckschlüssel Systeme

122-175

Universal Werkzeugkoffer

176-177

Schraubenschlüssel

178-185

Schraubendreher und Bits

186-198

Zangen

199-208

VDE Werkzeuge

209-212

Schlag-, Schaber- und Lösewerkzeuge

213-220

Diverse Handwerkzeuge

220-221

Schneiden und Sägen

221-227



**V5202**, EAN 4047728**068987**

## Steckschlüssel Satz · superflach

- Flaches Einsatz-Profil – Direktes Ansetzen an der Mutter / Verschraubung
- Robuste Vollstahl-Umschaltknarre
- Rechts- und Linksbetrieb
- Ergonomischer Griff
- Steckschlüssel-Einsätze ohne Einlauf Fase
- Superkurze Einsätze ermöglichen Arbeiten an sehr engen Stellen
- Durchgängige Steckschlüsseleinsätze ermöglichen Arbeiten an Stehbolzen
- Steckschlüssel-Einsätze mit Außensechskant SW 11 mm zur Befügung mit Ring- oder Maulschlüssel
- Für Handbetätigung

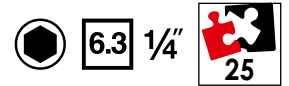

Inklusive Bit-Halter und Bits

**89,10 €**  
zzgl. MwSt.

XX	■		Ausführung	SW
3 x	6.3 1/4	⊖		0.8 x 4 · 1 x 5 · 1 x 6 mm
2 x	6.3 1/4	⊕		PH1 · PH2
5 x	6.3 1/4	⊗		T15 · T20 · T25 · T27 · T30
1 x	-	6.3 1/4		-
1 x	6.3 1/4	6.3 1/4		-
13 x	6.3 1/4	⊙		4 · 4.5 · 5 · 5.5 · 6 · 7 · 8 · 9 · 10 · 11 · 12 · 13 · 14 mm

**V3734N**, EAN 4047728**056427**

## Steckschlüssel Satz

- Für Handbetätigung



Einzelteilaufistung ab Seite 124

XX	■		Ausführung	SW
2 x	6.3 1/4	⊕		PH1 · PH2
2 x	6.3 1/4	⊕		PZ1 · PZ2
4 x	6.3 1/4	⊗		T15 · T20 · T25 · T30
1 x	6.3 1/4	6.3 1/4		25 mm
12 x	6.3 1/4	⊙		4 · 4.5 · 5 · 5.5 · 6 · 7 · 8 · 9 · 10 · 11 · 12 · 13 mm
1 x	-	6.3 1/4		150 mm
1 x	6.3 1/4	6.3 1/4		100 mm

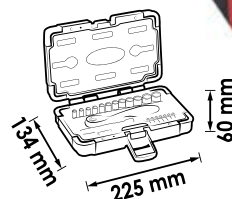

**52,05 €**  
zzgl. MwSt.

**V2414N**, EAN 4047728**056434**

**Steckschlüssel Satz**

• Für Handbetätigung



Einzelteilaufistung ab Seite 124

XX	■	●	Ausführung	SW
13 x	6.3 1/4	●		4 · 4.5 · 5 · 5.5 · 6 · 7 · 8 · 9 · 10 · 11 · 12 · 13 · 14 mm
3 x	6.3 1/4	●		0.8x4 · 1x5.5 · 1.2x7 mm
6 x	6.3 1/4	○		3 · 4 · 5 · 6 · 7 · 8 mm
3 x	6.3 1/4	+		PH1 · PH2 · PH3
3 x	6.3 1/4	+		PZ1 · PZ2 · PZ3
6 x	6.3 1/4	⊕		T10 · T15 · T20 · T25 · T30 · T40
2 x	-	○		1.3 · 2 mm
1 x	10 3/8	6.3 1/4		27 mm
1 x	6.3 1/4	6.3 1/4		110 mm
1 x	6.3 1/4	6.3 1/4		50 mm
1 x	6.3 1/4	6.3 1/4		100 mm
1 x	6.3 1/4	6.3 1/4		145 mm
1 x	6.3 1/4	6.3 1/4		40 mm
1 x	-	6.3 1/4		150 mm
1 x	-	6.3 1/4		150 mm

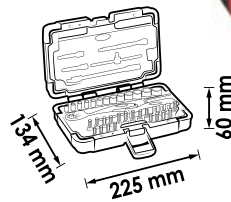

**73,95 €**

zzgl. MwSt.

**V7514/13**, EAN 4047728**074063**

**Doppelsechskant Steckschlüssel Satz**

• Für Handbetätigung

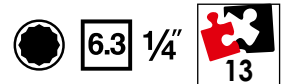

Einzelteilaufistung Seite 127

XX	■	●	Ausführung	SW
13 x	6.3 1/4	●		4 · 4.5 · 5 · 5.5 · 6 · 7 · 8 · 9 · 10 · 11 · 12 · 13 · 14 mm



**19,50 €**

zzgl. MwSt.



**V1897**, EAN 4047728**018975**

## Multiprofil Steckschlüsseleinsatz Satz

• Für Handbetätigung

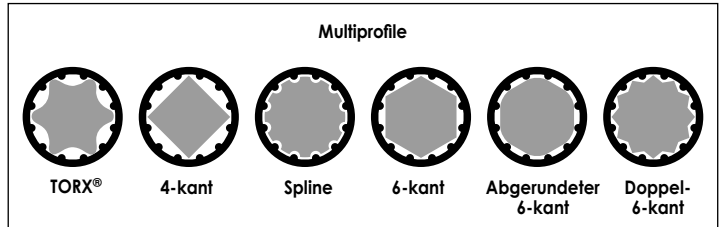
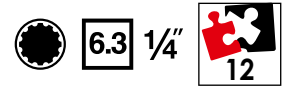

Einzelteilaufistung Seite 128

XX	■	●	Ausführung	SW
12 x	6.3 1/4	●		4 · 5 · 5.5 · 6 · 7 · 8 · 9 · 10 · 11 · 12 · 13 · 14 mm

Alle Einsätze für  
6 Profile geeignet

**37,85 €**  
zzgl. MwSt.

**V6014**, EAN 4047728**055833**

## Feinzahn-Umschaltknarre

- Gekröpfte Ausführung
- Kunststoffummantel
- Auslöseknopf
- 72 Zähne
- 5° Betätigungswinkel
- Für Handbetätigung



**32,20 €**  
zzgl. MwSt.



6.3 1/4

**V6014-REP**, EAN 4047728**056519**

## Reparatur Satz

- Reparatur Satz für Feinzahn-Umschaltknarre V6014



**12,35 €**  
zzgl. MwSt.

**V4944-S**, EAN 4047728**055345**

## Feinzahn-Umschaltknarre · Standard

- Robust und servicefreundlich
- Geschlossenes System
- Leicht zu reinigen
- 72 Zähne
- 5° Betätigungswinkel
- Für Handbetätigung



**39,45 €**  
zzgl. MwSt.

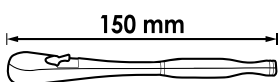

6.3 1/4

**V4944-REP**, EAN 4047728**049474**

## Reparatur Satz

- Reparatur Satz für Feinzahn-Umschaltknarren V4944 · V4944-S · V4944-XS



**23,90 €**  
zzgl. MwSt.

**V4944-XS**, EAN 4047728069557

## Feinzahn-Umschaltknarre · extrakurze Ausführung

- Robust und servicefreundlich
- Geschlossenes System
- Leicht zu reinigen
- 72 Zähne
- 5° Betätigungswinkel
- Für Handbetätigung



6.3 1/4"

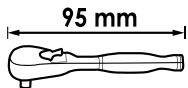

6.3 1/4"



**37,20 €**  
zzgl. MwSt.

**V5436**, EAN 4047728054362

## 360° Drehgriff-Umschaltknarre

- Einsatz in beengten Bereichen
- Durchsteckvierkant für Rechts- / Linksbetrieb
- Standard-Betätigung durch Feststellen möglich
- Betätigung nur rechtslaufend
- 72 Zähne
- 5° Betätigungswinkel
- Für Handbetätigung

Lösen und Anziehen von Verschraubungen  
nur im arretierten Modus

6.3 1/4"

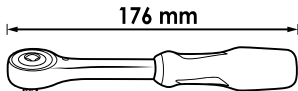

6.3 1/4"



Antriebsmechanismus  
im 360° Drehgriff

**46,90 €**  
zzgl. MwSt.

**V6614N**, EAN 4047728080354

## Teleskop Gelenk-Umschaltknarre

- Ausziehbar von 175 – 225 mm
- 180° Schwenkbarer Kopf inklusive Arretierung
- Auslöseknopf
- 90 Zähne
- 4° Betätigungswinkel
- Für Handbetätigung

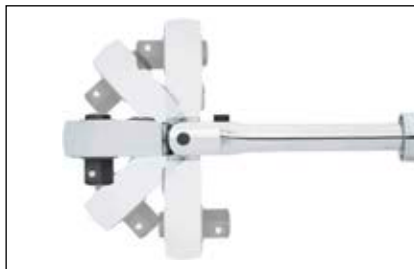

5 Positionen arretierbar

**NEU**

6.3 1/4"



**39,90 €**  
zzgl. MwSt.

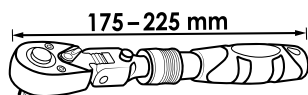

**V6614N-REP**, EAN 4047728081757

## Reparatur Satz

- Reparatur Satz für Teleskop Gelenk-Umschaltknarre V6614N



**11,90 €**  
zzgl. MwSt.



**V2941**, EAN 4047728029414

## Fingerratsche

- 1/4" 6.3" Fingerratsche, einzeln, für Bits
- 72 Zähne
- 5° Betätigungswinkel
- Für Handbetätigung

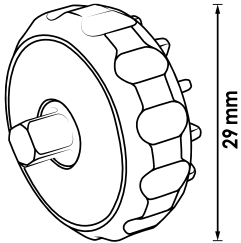

6.3 1/4" 6.3 1/4"

**17,55 €**  
zzgl. MwSt.

**V2458N**, EAN 4047728058179

## Steckgriff

- Für Handbetätigung



6.3 1/4"

**8,05 €**  
zzgl. MwSt.

**V2453N**, EAN 4047728058124

## Gleitgriff

- Für Handbetätigung



6.3 1/4" 6.3 1/4"

**4,55 €**  
zzgl. MwSt.





## Sechskant Steckschlüsseinsatz



VIGOR No.	SW	L mm	EAN 4047728+	€
V2413N	4 mm	25	057738	2,55
V2415N	4.5 mm	25	057745	2,55
V2416N	5 mm	25	057752	2,55
V2417N	5.5 mm	25	057769	2,55
V2418N	6 mm	25	057776	2,55
V2419N	7 mm	25	057783	2,55
V2420N	8 mm	25	057790	2,55

VIGOR No.	SW	L mm	EAN 4047728+	€
V2421N	9 mm	25	057806	2,55
V2422N	10 mm	25	057813	2,55
V2423N	11 mm	25	057820	2,55
V2424N	12 mm	25	057837	2,55
V2425N	13 mm	25	057844	2,80
V2426N	14 mm	25	057851	3,15

## Doppelsechskant Steckschlüsseinsatz



VIGOR No.	SW	L mm	EAN 4047728+	€
V7514-4	4 mm	25	074070	2,55
V7514-4.5	4.5 mm	25	074087	2,55
V7514-5	5 mm	25	074094	2,55
V7514-5.5	5.5 mm	25	074100	2,55
V7514-6	6 mm	25	074117	2,55
V7514-7	7 mm	25	074124	2,55
V7514-8	8 mm	25	074131	2,55

VIGOR No.	SW	L mm	EAN 4047728+	€
V7514-9	9 mm	25	074148	2,55
V7514-10	10 mm	25	074155	2,55
V7514-11	11 mm	25	074162	2,55
V7514-12	12 mm	25	074179	2,55
V7514-13	13 mm	25	074186	2,80
V7514-14	14 mm	25	074193	3,15

## Sechskant Steckschlüsseinsatz · lang



VIGOR No.	SW	L mm	EAN 4047728+	€
V2533N	4 mm	50	058193	3,65
V2534N	5 mm	50	058209	3,65
V2535N	6 mm	50	058216	3,65
V2536N	7 mm	50	058223	3,65
V2537N	8 mm	50	058230	3,65

VIGOR No.	SW	L mm	EAN 4047728+	€
V2538N	9 mm	50	058247	3,65
V2539N	10 mm	50	058254	3,65
V2699N	11 mm	50	058735	3,65
V2700N	12 mm	50	058742	3,65
V2701N	13 mm	50	058759	3,65

## Doppelsechskant Steckschlüsseinsatz · lang

**NEU**



VIGOR No.	SW	EAN 4047728+	€
V7514L-4	4 mm	080514	3,80
V7514L-5	5 mm	080521	3,80
V7514L-5.5	5.5 mm	080538	3,80
V7514L-6	6 mm	080545	3,80
V7514L-7	7 mm	080552	3,80
V7514L-8	8 mm	080569	3,80

VIGOR No.	SW	EAN 4047728+	€
V7514L-9	9 mm	080576	3,80
V7514L-10	10 mm	080583	4,40
V7514L-11	11 mm	080590	3,80
V7514L-12	12 mm	080606	3,80
V7514L-13	13 mm	080613	3,80

## T Steckschlüsseinsatz

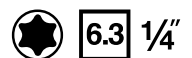

VIGOR No.	SW	L mm	EAN 4047728+	€
V2185	E4	24.8	021852	3,90
V2186	E5	24.8	021869	3,90
V2187	E6	24.8	021876	3,90
V2188	E7	24.8	021883	3,90
V2189	E8	24.8	021890	3,90
V2722	E10	24.8	027229	4,65
V2723	E11	24.8	027236	4,65



## T-Plus Steckschlüsseinsatz



VIGOR No.	SW	EAN 4047728+	€
V7920-EP4	E4+	078146	3,90
V7920-EP5	E5+	078153	3,90
V7920-EP6	E6+	078160	3,90
V7920-EP7	E7+	078177	3,90
V7920-EP8	E8+	078184	3,90

## Multiprofil Steckschlüsseinsatz



VIGOR No.	SW	L mm	EAN 4047728+	€
V1976	4 mm	25	019767	3,30
V1977	5 mm	25	019774	3,30
V1978	5.5 mm	25	019781	3,30
V1979	6 mm	25	019798	3,30
V1980	7 mm	25	019804	3,30
V1981	8 mm	25	019811	3,30

VIGOR No.	SW	L mm	EAN 4047728+	€
V1982	9 mm	25	019828	3,30
V1983	10 mm	25	019835	3,30
V1984	11 mm	25	019842	3,30
V1985	12 mm	25	019859	3,30
V1986	13 mm	25	019866	3,30
V1987	14 mm	25	019873	3,30

## T Schraubendreher-Einsatz



VIGOR No.	SW	L mm	EAN 4047728+	€
V2595N	T9	38	058599	2,75
V2442N	T10	38	058018	2,55
V2443N	T15	38	058025	2,55
V2444N	T20	38	058032	2,55

VIGOR No.	SW	L mm	EAN 4047728+	€
V2445N	T25	38	058049	2,55
V2130N	T27	38	057042	2,55
V2446N	T30	38	058056	2,55
V2447N	T40	38	058063	2,55

## T-Plus Schraubendreher-Einsatz



VIGOR No.	SW	EAN 4047728+	€
V7037-IP8	T8+	078276	2,55
V7037-IP10	T10+	078283	2,55
V7037-IP15	T15+	078290	2,55
V7037-IP20	T20+	078306	2,55
V7037-IP25	T25+	078313	2,55
V7037-IP27	T27+	078320	2,55
V7037-IP30	T30+	078337	2,55

## T Schraubendreher-Einsatz



VIGOR No.	SW	L mm	EAN 4047728+	€
V7037-T8H	T8H	37	082310	3,30
V2596N	T9H	37	058605	3,30
V2136	T10H	37	021364	2,55
V2138	T15H	37	021388	2,55
V2139	T20H	37	021395	2,55
V2140	T25H	37	021401	2,55
V2141	T27H	37	021418	2,55
V2142	T30H	37	021425	2,55

## T-Plus Schraubendreher-Einsatz

6.3 1/4"



VIGOR No.	SW	EAN 4047728+	€
V7037-IPR8	T8+H	078399	3,30
V7037-IPR10	T10+H	078405	3,30
V7037-IPR15	T15+H	078412	3,30
V7037-IPR20	T20+H	078429	3,30
V7037-IPR25	T25+H	078436	3,30
V7037-IPR27	T27+H	078443	3,30
V7037-IPR30	T30+H	078450	3,30

## Schraubendreher-Einsatz

6.3 1/4"



VIGOR No.	SW	L mm	EAN 4047728+	€
V2593N	PH0	38	058575	2,80
V2436N	PH1	38	057950	2,80
V2437N	PH2	38	057967	2,80
V2438N	PH3	38	057974	2,80

## Schraubendreher-Einsatz

6.3 1/4"



VIGOR No.	SW	L mm	EAN 4047728+	€
V2594N	PZ0	38	058582	2,80
V2439N	PZ1	38	057981	2,80
V2440N	PZ2	38	057998	2,80
V2441N	PZ3	38	058001	2,80

## Schraubendreher-Einsatz

6.3 1/4"



VIGOR No.	SW	L mm	EAN 4047728+	€
V2427N	0.8x4 mm	38	057868	2,80
V2428N	1x5.5 mm	38	057875	2,80
V2597N	1.2x6.5 mm	38	058612	2,80
V2429N	1.2x7 mm	38	057882	2,80

## Innensechskant Schraubendreher-Einsatz

6.3 1/4"



VIGOR No.	SW	L mm	EAN 4047728+	€
V2430N	3 mm	38	057899	2,80
V2431N	4 mm	38	057905	2,80
V2432N	5 mm	38	057912	2,80
V2433N	6 mm	38	057929	2,80
V2434N	7 mm	38	057936	2,80
V2435N	8 mm	38	057943	2,80

## Flexible Verlängerung

6.3 1/4" 6.3 1/4"



VIGOR No.	mm	EAN 4047728+	€
V2457N	145	058162	6,45

## Schwenkbare Verlängerung

- Betätigung von Schraubverbindungen auf engem Raum und Umgehen von Störkanten
- Kugelförmiger, konischer Außenvierkant

6.3 1/4" 6.3 1/4"



VIGOR No.	mm	EAN 4047728+	€
V4311	36	043113	4,65
V4312	75	043120	5,90
V4313	250	043137	11,65

## Verlängerung

6.3 1/4" 6.3 1/4"



VIGOR No.	mm	EAN 4047728+	€
V2455N	50	058148	3,40
V2456N	100	058155	4,55

## Universalgelenk

6.3 1/4 6.3 1/4



VIGOR No.	mm	EAN 4047728+	€
V2454N	40	058131	6,45

## Adapter

10 3/8 6.3 1/4



VIGOR No.	mm	EAN 4047728+	€
V2014	26	020145	2,15

## Adapter

6.3 1/4 6.3 1/4



VIGOR No.	mm	EAN 4047728+	€
V2452N	25	058117	2,40

## Bit Adapter

6.3 1/4 6.3 1/4



VIGOR No.	mm	EAN 4047728+	€
V3651N	25	058872	2,40

Folgt uns auf

Instagram



vigor\_equipment\_official



V6202, EAN 4047728062022

## Steckschlüssel Satz · superflach

- Flaches Einsatz-Profil – Direktes Ansetzen an der Mutter / Verschraubung
- Robuste Vollstahl-Umschaltknarre
- Rechts- und Linksbetrieb
- Ergonomischer Griff
- Steckschlüssel-Einsätze ohne Einlauffase
- Superkurze Einsätze ermöglichen Arbeiten an sehr engen Stellen
- Steckschlüssel-Einsätze mit Außensechskant SW 17 mm zur Betätigung mit Ring- oder Maulschlüssel
- Für Handbetätigung

Dein Problemlöser bei flachen Verschraubungen und engen Räumen

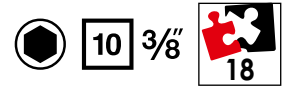

Ohne Einlauffase  
Für geringe  
Schraubenkopf-Höhen



**134,50 €**  
zzgl. MwSt.

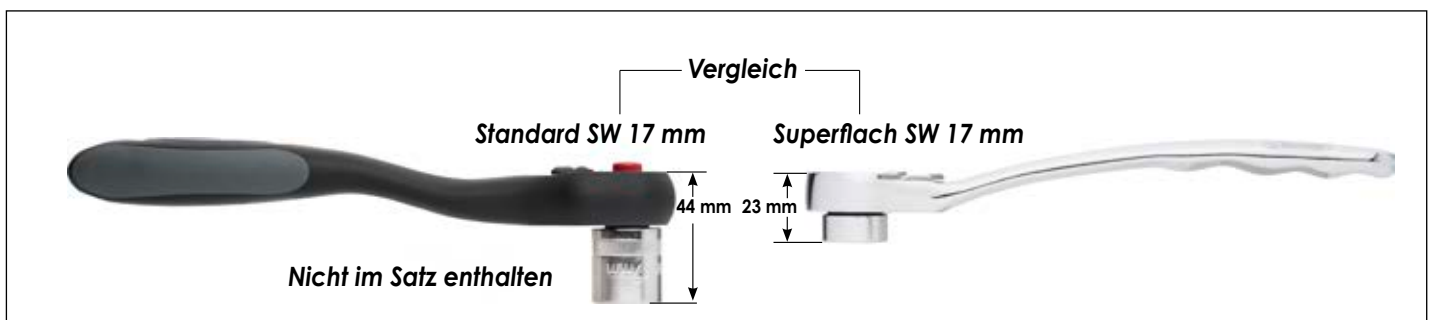

XX	■		Ausführung	SW
1 x	-	10 3/8"		200 mm
1 x	17 mm	10 3/8"		30 mm
1 x	10 3/8"	10 3/8"		60 mm
1 x	10 3/8"	10 3/8"		75 mm
1 x	10 3/8"	10 3/8"		150 mm
13 x	10 3/8"			8 · 9 · 10 · 11 · 12 · 13 · 14 · 15 · 16 · 17 · 19 · 21 · 22 mm



**V2305N**, EAN 4047728056441

Steckschlüssel Satz

• Für Handbetätigung

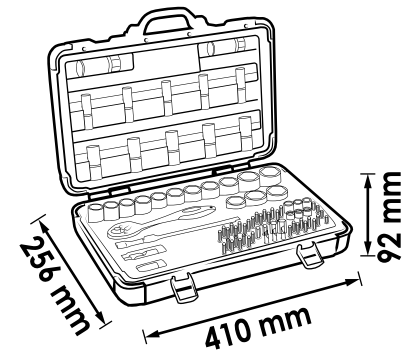

**143,- €**  
zzgl. MwSt.

## Einzelteilliste ab Seite 135

XX	■	■	Ausführung	SW
18 x	10 3/8	●		6 · 7 · 8 · 9 · 10 · 11 · 12 · 13 · 14 · 15 · 16 · 17 · 18 · 19 · 20 · 21 · 22 · 24 mm
10 x	10 3/8	●		8 · 9 · 10 · 11 · 12 · 13 · 14 · 15 · 17 · 19 mm
2 x	10 3/8	●		16 · 21 mm
7 x	10 3/8	○		3 · 4 · 5 · 6 · 7 · 8 · 10 mm
3 x	10 3/8	●		0.8x5.5 · 1x7 · 1.2x8 mm
3 x	10 3/8	+		PH1 · PH2 · PH3
3 x	10 3/8	+		PZ1 · PZ2 · PZ3
9 x	10 3/8	⊛		T15 · T20 · T25 · T27 · T30 · T40 · T45 · T50 · T55
1 x	10 3/8	⊛		28 mm
1 x	12 3/8	10 3/8		40 mm
1 x	10 3/8	10 3/8		75 mm
1 x	10 3/8	10 3/8		250 mm
1 x	10 3/8	10 3/8		50 mm
1 x	-	10 3/8		198 mm



**V7538/10**, EAN 4047728074209

## Doppelsechskant Steckschlüssel Satz

- Für Handbetätigung

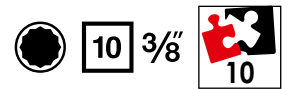

Einzelteilaufistung Seite 136

XX	■	⊙	Ausführung	SW
10 x	10 3/8	⊙		10 · 11 · 12 · 13 · 14 · 15 · 16 · 17 · 18 · 19 mm

**21,60 €**  
zzgl. MwSt.

**V6017**, EAN 4047728064361

## T Schraubendreher-Einsatz Satz

- Klingen phosphatiert
- Chrom-Vanadium Stahl
- Rändelung
- Für Handbetätigung

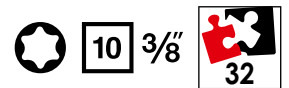

Einzelteilaufistung ab Seite 138

XX	■	⊙	Ausführung	SW
8 x	10 3/8	⊙		T20 · T25 · T27 · T30 · T40 · T45 · T50 · T55
2 x	10 3/8	⊙		T60 · T70
10 x	10 3/8	⊙		T20 · T25 · T27 · T30 · T40 · T45 · T50 · T55 · T60 · T70
6 x	10 3/8	⊙		T40 · T45 · T50 · T55 · T60 · T70
6 x	10 3/8	⊙		T40 · T45 · T50 · T55 · T60 · T70

**112,- €**  
zzgl. MwSt.

**V6018**, EAN 4047728065894

## Innenvielzahn Schraubendreher-Einsatz Satz (XZN)

- Klingen phosphatiert
- Chrom-Vanadium Stahl
- Rändelung
- Für Handbetätigung

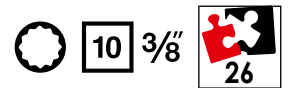

Einzelteilaufistung Seite 140

XX	■	⊙	Ausführung	SW
8 x	10 3/8	⊙		M5 · M6 · M8 · M9 · M10 · M12 · M14 · M16
7 x	10 3/8	⊙		M5 · M6 · M8 · M9 · M10 · M12 · M14
7 x	10 3/8	⊙		M5 · M6 · M8 · M9 · M10 · M12 · M14
4 x	10 3/8	⊙		M8 · M10 · M12 · M14

**112,- €**  
zzgl. MwSt.

**V6019**, EAN 4047728065900

## Innensechskant Schraubendreher-Einsatz Satz

- Klingen phosphatiert
- Chrom-Vanadium Stahl
- Rändelung
- Für Handbetätigung

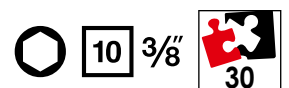

Einzelteilaufistung Seite 141

XX	■	⊙	Ausführung	SW
9 x	10 3/8	⊙		5 · 6 · 7 · 8 · 10 · 12 · 14 · 17 · 19 mm
8 x	10 3/8	⊙		5 · 6 · 7 · 8 · 10 · 11 · 12 · 13 mm
7 x	10 3/8	⊙		5 · 6 · 7 · 8 · 10 · 12 · 14 mm
6 x	10 3/8	⊙		5 · 6 · 7 · 8 · 10 · 12 mm

**112,- €**  
zzgl. MwSt.



**V6038**, EAN 4047728055840

## Feinzahn-Umschaltknarre

- Gekröpfte Ausführung
- Kunststoffummantelt
- Auslöseknopf
- DIN 3122, ISO 3315
- 72 Zähne
- 5° Betätigungswinkel
- Für Handbetätigung



10 3/8"

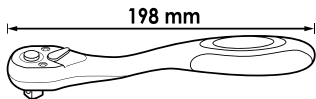

10 3/8"

**34,35 €**  
zzgl. MwSt.

**V6038-REP**, EAN 4047728056526

## Reparatur Satz

- Reparatur Satz für Feinzahn-Umschaltknarre V6038



10 3/8"

**12,35 €**  
zzgl. MwSt.

**V6638N**, EAN 4047728080347

## Teleskop Gelenk-Umschaltknarre

- Ausziehbar von 250 – 350 mm
- 180° Schwenkbarer Kopf inklusive Arretierung
- Auslöseknopf
- 90 Zähne
- 4° Betätigungswinkel
- Für Handbetätigung



10 3/8"



**NEU**

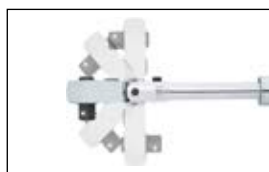

5 Positionen arretierbar

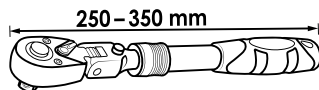

**49,90 €**  
zzgl. MwSt.

**V6638N-REP**, EAN 4047728081740

## Reparatur Satz

- Reparatur Satz für Teleskop Gelenk-Umschaltknarre V6638N



**12,35 €**  
zzgl. MwSt.

**V4945-S**, EAN 4047728055352

## Feinzahn-Umschaltknarre · Standard

- Robust und servicefreundlich
- Geschlossenes System
- Leicht zu reinigen
- 72 Zähne
- 5° Betätigungswinkel
- Für Handbetätigung



10 3/8"

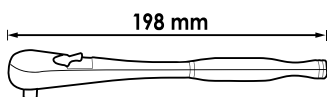

10 3/8"

**45,15 €**  
zzgl. MwSt.

**V4945-REP**, EAN 4047728049481

## Reparatur Satz

- Reparatur Satz für Feinzahn-Umschaltknarren V4945 · V4945-S



**24,80 €**  
zzgl. MwSt.

**V6008**, EAN 4047728060080

## 360° Drehgriff-Umschaltknarre

- Einsatz in beengten Bereichen
- Durchsteckvierkant für Rechts- / Linksbetrieb
- Standard-Betätigung durch Feststellen möglich
- Betätigung nur rechtslaufend
- 72 Zähne
- 5° Betätigungswinkel
- Für Handbetätigung

Lösen und Anziehen von Verschraubungen  
nur im arretierten Modus



10 3/8"



Antriebsmechanismus im 360° Drehgriff

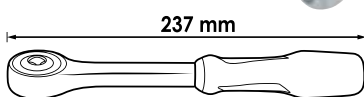

10 3/8"

**53,35 €**  
zzgl. MwSt.



## Sechskant Steckschlüsseleinsatz



VIGOR No.	SW	L mm	EAN 4047728+	€
V2278N	6 mm	28	057219	4,10
V2277N	7 mm	28	056908	4,10
V2276N	8 mm	28	056892	4,10
V2275N	9 mm	28	056885	4,10
V2274N	10 mm	28	056878	4,10
V2273N	11 mm	28	056861	4,10
V2272N	12 mm	28	056854	4,10
V2271N	13 mm	28	056847	4,10
V2270N	14 mm	28	056830	4,10

VIGOR No.	SW	L mm	EAN 4047728+	€
V2269N	15 mm	28	057141	4,10
V2268N	16 mm	28	057134	4,10
V2267N	17 mm	30	057127	4,10
V2266N	18 mm	30	057110	4,10
V2265N	19 mm	30	057103	4,10
V2264N	20 mm	30	057097	4,35
V2263N	21 mm	30	057080	4,35
V2262N	22 mm	30	057073	4,35
V2261N	24 mm	30	057066	5,45

## Doppelsechskant Steckschlüsseleinsatz



VIGOR No.	SW	L mm	EAN 4047728+	€
V7538-9	9 mm	28	080439	4,15
V7538-10	10 mm	28	074230	4,10
V7538-11	11 mm	28	074247	4,10
V7538-12	12 mm	28	074254	4,10
V7538-13	13 mm	28	074261	4,10
V7538-14	14 mm	28	074278	4,10
V7538-15	15 mm	28	074285	4,10
V7538-16	16 mm	28	074292	4,10
V7538-17	17 mm	30	074308	4,10
V7538-18	18 mm	30	074315	4,10
V7538-19	19 mm	30	074322	4,10

## Sechskant Steckschlüsseleinsatz · lang



VIGOR No.	SW	L mm	EAN 4047728+	€
V2016N	8 mm	63	056922	5,45
V2017N	9 mm	63	056939	5,45
V2018N	10 mm	63	056946	5,45
V2019N	11 mm	63	056953	5,45
V2020N	12 mm	63	056960	5,45
V2311N	13 mm	63	057509	5,45
V2312N	14 mm	63	057516	6,60
V2313N	15 mm	63	057523	6,60
V2314N	17 mm	63	057530	7,15
V2315N	19 mm	63	057547	7,85

## Doppelsechskant Steckschlüsseleinsatz · lang

**NEU**

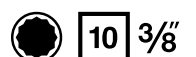

VIGOR No.	SW	EAN 4047728+	€
V7538L-9	9 mm	080644	5,50
V7538L-10	10 mm	080651	5,50
V7538L-11	11 mm	080668	5,50
V7538L-12	12 mm	080675	5,50
V7538L-13	13 mm	080682	6,-
V7538L-14	14 mm	080699	6,60
V7538L-15	15 mm	080705	7,-
V7538L-16	16 mm	080712	7,-
V7538L-17	17 mm	080729	7,50
V7538L-18	18 mm	080736	8,-
V7538L-19	19 mm	080743	8,-

## T Steckschlüsseinsatz



VIGOR No.	SW	← L → mm	EAN 4047728+	€
V2724	E4	28	027243	5,45
V2725	E5	28	027250	5,45
V2726	E6	28	027267	5,45
V2727	E7	28	027274	5,45
V2728	E8	28	027281	5,45
V2143	E10	28	021432	5,45

VIGOR No.	SW	← L → mm	EAN 4047728+	€
V2614N	E11	28	058674	5,45
V2144	E12	28	021449	5,45
V2145	E14	28	021456	5,45
V2146	E16	28	021463	6,70
V2615N	E18	28	058681	6,70
V2729	E20	28	027298	6,70

## T-Plus Steckschlüsseinsatz



VIGOR No.	SW	EAN 4047728+	€
V7920-EP10	E10+	078191	6,70
V7920-EP12	E12+	078207	6,70
V7920-EP14	E14+	078214	6,70
V7920-EP16	E16+	078221	6,70

## Zündkerzen-Einsatz



VIGOR No.	SW	← L → mm	EAN 4047728+	€
V2119N	16 mm	66	057028	5,45
V2613N	18 mm	66	058667	5,45
V2120N	21 mm	66	057035	6,30

## Schraubendreher-Einsatz



VIGOR No.	SW	← L → mm	EAN 4047728+	€
V2288N	0.8x5.5 mm	49	057318	4,50
V2287N	1x7 mm	49	057301	5,45
V2286N	1.2x8 mm	49	057295	5,45



## Schraubendreher-Einsatz

10 3/8"



VIGOR No.	SW	← L → mm	EAN 4047728+	€
V2291N	PZ1	49	057349	4,50
V2290N	PZ2	49	057332	4,50
V2289N	PZ3	49	057325	4,50

## Schraubendreher-Einsatz

10 3/8"



VIGOR No.	SW	← L → mm	EAN 4047728+	€
V2294N	PH1	49	057370	4,50
V2293N	PH2	49	057363	4,50
V2292N	PH3	49	057356	4,50

## T Schraubendreher-Einsatz

10 3/8"



VIGOR No.	SW	← L → mm	EAN 4047728+	€
V2194	T45H	48	021944	6,70
V2195	T50H	48	021951	6,70

## T Schraubendreher-Einsatz

10 3/8"



VIGOR No.	SW	← L → mm	EAN 4047728+	€
V6082	T60	49	060820	7,-
V6083	T70	49	060837	7,30

## T Schraubendreher-Einsatz



VIGOR No.	SW	L mm	EAN 4047728+	€
V2303N	T15	49	057493	4,50
V2302N	T20	49	057486	4,50
V2301N	T25	49	057479	4,50
V2300N	T27	49	057462	4,50
V2299N	T30	49	057455	4,50
V2298N	T40	49	057448	4,50
V2297N	T45	49	057431	5,45
V2149	T47	49	021494	6,70
V2296N	T50	49	057394	6,70
V2295N	T55	49	057387	6,70

## T Schraubendreher-Einsatz



VIGOR No.	SW	L mm	EAN 4047728+	€
V6084	T20	93	060844	7,70
V6085	T25	93	060851	7,70
V6086	T27	93	060868	7,70
V6087	T30	93	060875	7,70
V6088	T40	93	060882	7,70
V6089	T45	93	060899	7,70
V6090	T50	93	060905	7,70
V6091	T55	93	060912	7,85
V6092	T60	93	060929	7,85
V6093	T70	93	060936	8,70

## T Schraubendreher-Einsatz



VIGOR No.	SW	L mm	EAN 4047728+	€
V6094	T40	133	060943	8,55
V6095	T45	133	060950	8,55
V6096	T50	133	060967	8,55
V6097	T55	133	060974	8,70
V6098	T60	133	060981	8,70
V6099	T70	133	060998	9,95

## T Schraubendreher-Einsatz



VIGOR No.	SW	L mm	EAN 4047728+	€
V6100	T40	193	061001	9,40
V6101	T45	193	061018	9,40
V6102	T50	193	061025	9,40
V6103	T55	193	061032	9,55
V6104	T60	193	061049	11,05
V6105	T70	193	061056	12,75



## Innenvielzahn Schraubendreher-Einsatz (XZN)



VIGOR No.	SW	L mm	EAN 4047728+	€
V6106	M5	48	061063	6,85
V6107	M6	48	061070	6,85
V6108	M8	48	061087	6,85
V6109	M9	48	061094	6,85
V6110	M10	48	061100	6,85
V6111	M12	48	061117	6,85
V6112	M14	48	061124	6,85
V6113	M16	48	061131	7,70

## Innenvielzahn Schraubendreher-Einsatz (XZN)



VIGOR No.	SW	L mm	EAN 4047728+	€
V6114	M5	93	061148	7,70
V6115	M6	93	061155	7,70
V6116	M8	93	061162	7,70
V6117	M9	93	061179	7,70
V6118	M10	93	061186	7,70
V6119	M12	93	061193	7,70
V6120	M14	93	061209	8,25

## Innenvielzahn Schraubendreher-Einsatz (XZN)



VIGOR No.	SW	L mm	EAN 4047728+	€
V6121	M5	133	061216	8,55
V6122	M6	133	061223	8,55
V6123	M8	133	061230	8,55
V6124	M9	133	061247	8,70
V6125	M10	133	061254	8,70
V6126	M12	133	061261	9,95
V6127	M14	133	061278	10,10

## Innenvielzahn Schraubendreher-Einsatz (XZN)



VIGOR No.	SW	L mm	EAN 4047728+	€
V6128	M8	193	061285	9,40
V6129	M10	193	061292	9,65
V6130	M12	193	061308	11,05
V6131	M14	193	061315	12,60

## Innensechskant Schraubendreher-Einsatz



VIGOR No.	SW	L mm	EAN 4047728+	€
V2285N	3 mm	49	057288	4,50
V2284N	4 mm	49	057271	4,50
V2283N	5 mm	49	057264	4,50
V2282N	6 mm	49	057257	4,50
V2281N	7 mm	49	057240	5,45
V2280N	8 mm	49	057233	5,45
V2279N	10 mm	49	057226	6,60
V6137	12 mm	49	061377	6,85
V6138	14 mm	49	061384	6,85
V6139	17 mm	49	061391	7,85
V6140	19 mm	49	061407	7,85

## Innensechskant Schraubendreher-Einsatz



VIGOR No.	SW	L mm	EAN 4047728+	€
V6141	5 mm	93	061414	7,15
V6142	6 mm	93	061421	7,15
V6143	7 mm	93	061438	7,15
V6144	8 mm	93	061445	7,15
V6145	10 mm	93	061452	7,15
V6146	11 mm	93	061469	7,15
V6147	12 mm	93	061476	7,15
V6148	13 mm	93	061483	8,-

## Innensechskant Schraubendreher-Einsatz



VIGOR No.	SW	L mm	EAN 4047728+	€
V6149	5 mm	133	061490	8,-
V6194	6 mm	133	062466	8,-
V6151	7 mm	133	061513	8,-
V6152	8 mm	133	061520	8,-
V6153	10 mm	133	061537	8,-
V6154	12 mm	133	061544	8,-
V6155	14 mm	133	061551	9,65

## Innensechskant Schraubendreher-Einsatz

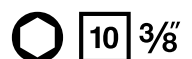

VIGOR No.	SW	L mm	EAN 4047728+	€
V6156	5 mm	193	061568	8,95
V6157	6 mm	193	061575	8,95
V6158	7 mm	193	061582	8,95
V6159	8 mm	193	061599	8,95
V6160	10 mm	193	061605	10,65
V6161	12 mm	193	061612	9,95



## Universalgelenk

10 3/8 10 3/8



VIGOR No.	mm	EAN 4047728+	€
V2118N	50	057011	7,60

## Verlängerung

10 3/8 10 3/8



VIGOR No.	mm	EAN 4047728+	€
V2115N	75	056984	4,75
V2616N	125	058698	5,85
V2117N	250	057004	9,90

## Schwenkbare Verlängerung

- Befähigung von Schraubverbindungen auf engem Raum und Umgehen von Störkanten
- Kugelförmiger, konischer Außenvierkant
- Schwenkwinkel nach jeder Seite 8°

10 3/8 10 3/8



VIGOR No.	mm	EAN 4047728+	€
V4314	36	043144	6,10
V4315	75	043151	6,45
V4316	250	043168	11,05





## Schiebestück / Adapter

**10 3/8** **12<sup>5</sup> 1/2**



VIGOR No.	mm	EAN 4047728+	€
V2116N	40	056991	5,35

## Bit Adapter

**8 5/16** **10 3/8**



VIGOR No.	mm	EAN 4047728+	€
V2114N	28	056977	4,05

## Adapter

**6.3 1/4** **10 3/8**



VIGOR No.	mm	EAN 4047728+	€
V2071	27	020718	3,05

## Adapter

**12<sup>5</sup> 1/2** **10 3/8**



VIGOR No.	mm	EAN 4047728+	€
V2108	36	021081	4,90

## Bit Adapter

**10 3/8** **8 5/16**



VIGOR No.	mm	EAN 4047728+	€
V3652N	30	058889	2,90



**V7202**, EAN 4047728**068888**

## Steckschlüssel Satz · superflach

- Robuste Vollstahl-Umschaltknarre
- Rechts- und Linksbetrieb
- Ergonomischer Griff
- Steckschlüssel-Einsätze ohne Einlauffase
- Superkurze Einsätze ermöglichen Arbeiten an sehr engen Stellen
- Durchgängige Steckschlüsseleinsätze ermöglichen Arbeiten an Stehbolzen
- Steckschlüssel-Einsätze mit Außensechskant SW 22 mm zur Befügung mit Ring-, oder Maulschlüssel
- Für Handbetätigung

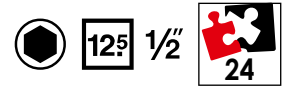

**251,50 €**  
zzgl. MwSt.

XX	■		Ausführung	SW
1 x	-	12.5 1/2		-
1 x	22 mm	12.5 1/2		-
1 x	12.5 1/2	12.5 1/2		-
1 x	12.5 1/2	12.5 1/2		125 mm
1 x	12.5 1/2	12.5 1/2		250 mm
19 x	12.5 1/2			8 · 9 · 10 · 11 · 12 · 13 · 14 · 15 · 16 · 17 · 18 · 19 · 20 · 21 · 22 · 24 · 27 · 30 · 32 mm

**V2460N**, EAN 4047728**056458**

## Steckschlüssel Satz

- Für Handbetätigung

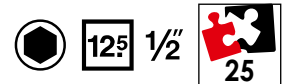

**119,- €**  
zzgl. MwSt.

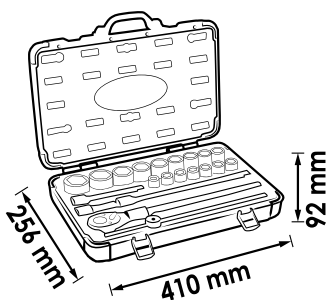

Einzelteilaufistung ab Seite 154

XX	■		Ausführung	SW
18 x	12.5 1/2			10 · 11 · 12 · 13 · 14 · 15 · 16 · 17 · 18 · 19 · 20 · 21 · 22 · 23 · 24 · 27 · 30 · 32 mm
2 x	12.5 1/2			16 · 21 mm
1 x	-	12.5 1/2		250 mm
1 x	12.5 1/2	12.5 1/2		125 mm
1 x	12.5 1/2	12.5 1/2		250 mm
1 x	12.5 1/2	12.5 1/2		75 mm
1 x	-	12.5 1/2		250 mm

**V7512/17**, EAN 4047728074216

## Doppelsechskant-Steckschlüssel Satz

• Für Handbetätigung



12<sup>5</sup> 1/2"



Einzelteilaufistung Seite 156

XX	■	●	Ausführung	SW
18 x	12 <sup>5</sup> 1/2"	●		8 · 10 · 11 · 12 · 13 · 14 · 15 · 16 · 17 · 18 · 19 · 20 · 21 · 22 · 24 · 27 · 30 · 32 mm

**50,30 €** zzgl. MwSt.

**V2496**, EAN 4047728024969

## Schraubendreher-Einsatz Satz

• Für Handbetätigung



12<sup>5</sup> 1/2"



Einzelteilaufistung ab Seite 158

XX	■	●	Ausführung	SW
8 x	12 <sup>5</sup> 1/2"	○		M5 · M6 · M8 · M9 · M10 · M12 · M14 · M16
9 x	12 <sup>5</sup> 1/2"	○		5 · 6 · 7 · 8 · 10 · 12 · 14 · 17 · 19 mm
9 x	12 <sup>5</sup> 1/2"	●		M5 · M6 · M7 · M8 · M9 · M10 · M12 · M13 · M14
10 x	12 <sup>5</sup> 1/2"	●		T20 · T25 · T27 · T30 · T40 · T45 · T50 · T55 · T60 · T70

**145,- €** zzgl. MwSt.



**V1917**, EAN 4047728019170

## T Schraubendreher-Einsatz Satz

• Für Handbetätigung

12<sup>5</sup> 1/2"

32



Einzelteilaufistung ab Seite 159

	■		Ausführung	SW
10 x		12 <sup>5</sup> 1/2"		T20 · T25 · T27 · T30 · T40 · T45 · T50 · T55 · T60 · T70
10 x		12 <sup>5</sup> 1/2"		T20 · T25 · T27 · T30 · T40 · T45 · T50 · T55 · T60 · T70
6 x		12 <sup>5</sup> 1/2"		T40 · T45 · T50 · T55 · T60 · T70
6 x		12 <sup>5</sup> 1/2"		T40 · T45 · T50 · T55 · T60 · T70

**129,50 €**  
zzgl. MwSt.

**V1918**, EAN 4047728019187

## Innenvielzahn Schraubendreher-Einsatz Satz (XZN)

• Für Handbetätigung

12<sup>5</sup> 1/2"

26



Einzelteilaufistung ab Seite 158

	■		Ausführung	SW
8 x		12 <sup>5</sup> 1/2"		M5 · M6 · M8 · M9 · M10 · M12 · M14 · M16
7 x		12 <sup>5</sup> 1/2"		M5 · M6 · M8 · M9 · M10 · M12 · M14
7 x		12 <sup>5</sup> 1/2"		M5 · M6 · M8 · M10 · M12 · M14 · M9
4 x		12 <sup>5</sup> 1/2"		M8 · M10 · M12 · M14

**129,50 €**  
zzgl. MwSt.

**V1919**, EAN 4047728019194

**Innensechskant Schraubendreher-Einsatz Satz**

• Für Handbetätigung

12<sup>5</sup> 1/2"

30



Einzelteilaufistung ab Seite 158

XX	■	○	Ausführung	SW
9 x	12 <sup>5</sup> 1/2"	○		5 · 6 · 7 · 8 · 10 · 12 · 14 · 17 · 19 mm
8 x	12 <sup>5</sup> 1/2"	○		5 · 6 · 7 · 8 · 10 · 11 · 12 · 13 mm
7 x	12 <sup>5</sup> 1/2"	○		5 · 6 · 7 · 8 · 10 · 12 · 14 mm
6 x	12 <sup>5</sup> 1/2"	○		5 · 6 · 7 · 8 · 10 · 12 mm

**129,50 €**  
zzgl. MwSt.

**V2201**, EAN 4047728022019

**RIBE Schraubendreher-Einsatz Satz**

• Für Handbetätigung

12<sup>5</sup> 1/2"

32



Einzelteilaufistung Seite 161

XX	■	⊛	Ausführung	SW
9 x	12 <sup>5</sup> 1/2"	⊛		M5 · M6 · M7 · M8 · M9 · M10 · M12 · M13 · M14
9 x	12 <sup>5</sup> 1/2"	⊛		M5 · M6 · M7 · M8 · M9 · M10 · M12 · M13 · M14
7 x	12 <sup>5</sup> 1/2"	⊛		M8 · M9 · M10 · M10.3 · M12 · M13 · M14
7 x	12 <sup>5</sup> 1/2"	⊛		M8 · M9 · M10 · M10.3 · M12 · M13 · M14

**142,50 €**  
zzgl. MwSt.



**V7917**, EAN 4047728**075831**

## T Kugelkopf Schraubendreher-Einsatz Satz

- Schwenkwinkel: 20°
- Für Handbetätigung



12<sup>5</sup> 1/2"



Einzelteilaufistung ab Seite 161

XX	■	⊙	Ausführung	SW
8 x	12 <sup>5</sup> 1/2"	⊙		T20 · T25 · T27 · T30 · T40 · T45 · T50 · T55
2 x	12 <sup>5</sup> 1/2"	⊙		T60 · T70
10 x	12 <sup>5</sup> 1/2"	⊙		T20 · T25 · T27 · T30 · T40 · T45 · T50 · T55 · T60 · T70
6 x	12 <sup>5</sup> 1/2"	⊙		T40 · T45 · T50 · T55 · T60 · T70
6 x	12 <sup>5</sup> 1/2"	⊙		T40 · T45 · T50 · T55 · T60 · T70

**143,- €**

zzgl. MwSt.

**V7919**, EAN 4047728**075817**

## Innensechskant Kugelkopf Schraubendreher-Einsatz Satz

- Schwenkwinkel: 20°
- Für Handbetätigung



12<sup>5</sup> 1/2"



Einzelteilaufistung ab Seite 162

XX	■	⊙	Ausführung	SW
7 x	12 <sup>5</sup> 1/2"	⊙		5 · 6 · 7 · 8 · 10 · 12 · 14 mm
2 x	12 <sup>5</sup> 1/2"	⊙		17 · 19 mm
8 x	12 <sup>5</sup> 1/2"	⊙		5 · 6 · 7 · 8 · 10 · 11 · 12 · 13 mm
7 x	12 <sup>5</sup> 1/2"	⊙		5 · 6 · 7 · 8 · 10 · 12 · 14 mm
6 x	12 <sup>5</sup> 1/2"	⊙		5 · 6 · 7 · 8 · 10 · 12 mm

**143,- €**

zzgl. MwSt.

**V1898**, EAN 4047728018982

## Multiprofil Steckschlüsseleinsatz Satz

• Für Handbetätigung

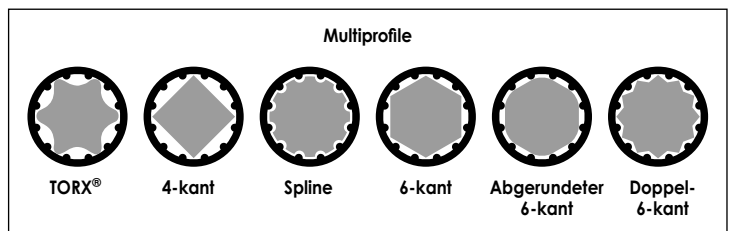
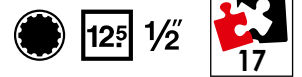

Alle Einsätze für  
6 Profile geeignet

Einzelteilaufistung Seite 157

XX	■	●	Ausführung	SW
17 x	12.5 1/2	●		10 · 11 · 12 · 13 · 14 · 15 · 16 · 17 · 18 · 19 · 20 · 21 · 22 · 24 · 27 · 30 · 32 mm

**104,50 €**  
zzgl. MwSt.

**V6412/4**, EAN 4047728079518

## Stehbolzen-Ausdreher Satz

- Beschädigungsfreies Ein- und Ausbauen von Stehbolzen und Gewindestiften
- Für Links- und Rechtsgewinde
- Antrieb Außensechskant 19 bzw. 22 mm
- Größen: 6 · 8 · 10 · 12 mm
- Für Handbetätigung

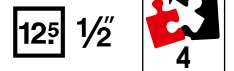

**NEU**



**40,- €**  
zzgl. MwSt.



**V2404N**, EAN 4047728**080507**

## Spiralnutenausdreher-Einsatz Satz

- Betätigung von Muttern mit rundgedrehten Köpfen (Spezialprofil)
- Für Handbetätigung

**NEU**

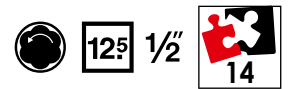

Einzelteilaufistung Seite 165

xx	■	Ausführung	SW
13 x	12.5 1/2		6 · 7 · 8 · 9 · 10 · 11 · 12 · 13 · 14 · 15 · 16 · 17 · 19 mm

**132,- €**  
zzgl. MwSt.

**V3741**, EAN 4047728**037419**

## Spiralnutenausdreher-Einsatz Satz

- Betätigung von Muttern mit rundgedrehten Köpfen (Spezialprofil)
- Für Handbetätigung

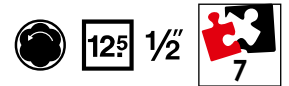

Einzelteilaufistung Seite 165

xx	■	Ausführung	SW
6 x	12.5 1/2		21 · 22 · 24 · 27 · 30 · 32 mm

**136,- €**  
zzgl. MwSt.



**V5550S**, EAN 4047728055819

## Schlagschrauber Steckschlüsseleinsatz Satz · kurz

- Oberfläche: phosphatiert
- Für Maschinenbetätigung

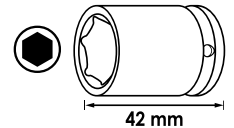
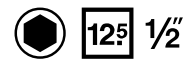

Einzelteilaufistung Seite 165

XX	■	●	Ausführung	SW
13 x	12.5 1/2	●		10 · 11 · 12 · 13 · 14 · 15 · 16 · 17 · 18 · 19 · 21 · 22 · 24 mm

**65,40 €**  
zzgl. MwSt.

**V5550L**, EAN 4047728055505

## Schlagschrauber Steckschlüsseleinsatz Satz · lang

- Oberfläche: phosphatiert
- Für Maschinenbetätigung

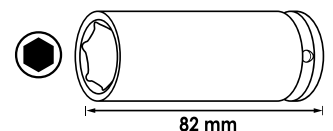

Einzelteilaufistung Seite 165

XX	■	●	Ausführung	SW
13 x	12.5 1/2	●		10 · 11 · 12 · 13 · 14 · 15 · 16 · 17 · 18 · 19 · 21 · 22 · 24 mm

**98,10 €**  
zzgl. MwSt.



**V7019**, EAN 4047728066372

**Schlagschrauber Schraubendreher-Einsatz Satz für Innensechskant Profil**

- Oberfläche: phosphatiert
- Für Maschinenbetätigung

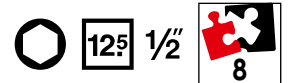

Einzelteilaufistung Seite 166

XX	■	Ausführung	SW
8 x	12.5 1/2		5 · 6 · 8 · 10 · 12 · 14 · 17 · 19 mm

**102,- €**  
zzgl. MwSt.

**V7018**, EAN 4047728066846

**Schlagschrauber Innenvielzahn Schraubendreher-Einsatz Satz (XZN)**

- Oberfläche: phosphatiert
- Für Maschinenbetätigung

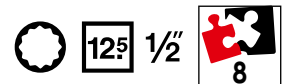

Einzelteilaufistung Seite 166

XX	■	Ausführung	SW
8 x	12.5 1/2		M5 · M6 · M8 · M10 · M12 · M14 · M16 · M18

**102,- €**  
zzgl. MwSt.

**V7017**, EAN 4047728**064705**

Schlagschrauber Schraubendreher-  
Einsatz Satz für Innen T Profil

- Oberfläche: phosphatiert
- Für Maschinenbetätigung



12<sup>5</sup> 1/2



Einzelteilaufistung Seite 165

XX	■	Ausführung	SW
8 x	12 <sup>5</sup> 1/2		T30 · T40 · T45 · T50 · T55 · T60 · T70 · T80

**101,-€**  
zzgl. MwSt.



**V6012**, EAN 4047728055826

## Feinzahn-Umschaltknarre

- Gekröpfte Ausführung
- Kunststoffummantelt
- Auslöseknopf
- DIN 3122, ISO 3315
- 72 Zähne
- 5° Betätigungswinkel
- Für Handbetätigung

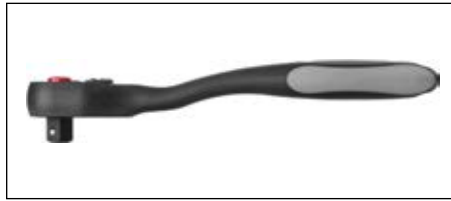

**48,35 €**  
zzgl. MwSt.

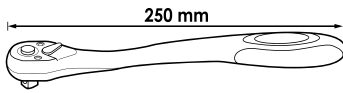

12.5 1/2

**V6012-REP**, EAN 4047728056533

## Reparatur Satz

- Reparatur Satz für Feinzahn-Umschaltknarre V6012 · V6612



**12,35 €**  
zzgl. MwSt.

**V4946-S**, EAN 4047728055369

## Feinzahn-Umschaltknarre · Standard

- Robust und servicefreundlich
- Geschlossenes System
- Leicht zu reinigen
- DIN 3122, ISO 3315
- 72 Zähne
- 5° Betätigungswinkel
- Für Handbetätigung



Geschlossenes System



Robuste Vollstahl-Ausführung



**68,70 €**  
zzgl. MwSt.

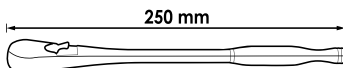

12.5 1/2

**V4946-REP**, EAN 4047728049498

## Reparatur Satz

- Reparatur Satz für Feinzahn-Umschaltknarren V4946 · V4946-S



**30,65 €**  
zzgl. MwSt.

**V4884**, EAN 4047728048842

## Gelenkgriff mit Umschaltknarre

- Vierkant-Antrieb mit Kugelarreterierung
- DIN 3122
- 24 Zähne
- 15° Betätigungswinkel
- Für Handbetätigung



Robuster 24-Zahn Ratschenmechanismus



180°

12.5 1/2

**83,85 €**  
zzgl. MwSt.

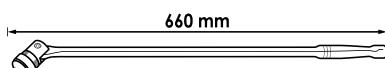

12.5 1/2

**V4884-01**, EAN 4047728073226

## Knarrenkopf



**32,30 €**  
zzgl. MwSt.

**V5437**, EAN 4047728054379

## 360° Drehgriff-Umschaltknarre

- Einsatz in beengten Bereichen
- Durchsteckvierkant für Rechts- / Linksbetrieb
- Standard-Betätigung durch Feststellen möglich
- Betätigung nur rechtslaufend
- 72 Zähne
- 5° Betätigungswinkel
- Für Handbetätigung



12<sup>5</sup> 1/2"



Lösen und Anziehen von Verschraubungen  
nur im arretierten Modus



Antriebs-  
mechanismus  
im Griff

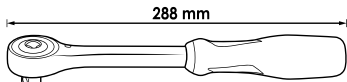

12<sup>5</sup> 1/2"

**70,80 €**  
zzgl. MwSt.

**V6612N**, EAN 4047728080330

## Teleskop Gelenk-Umschaltknarre

- Ausziehbar von 350 – 490 mm
- 180° Schwenkbarer Kopf inklusive Arretierung
- Auslöseknopf
- 90 Zähne
- 4° Betätigungswinkel
- Für Handbetätigung



5 Positionen arretierbar

12<sup>5</sup> 1/2"



**NEU**

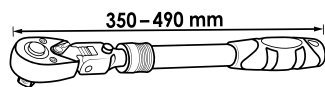

**66,60 €**  
zzgl. MwSt.

**V6612N-REP**, EAN 4047728081733

## Reparatur Satz

- Reparatur Satz für Teleskop Gelenk-Umschaltknarre V6612N



**12,35 €**  
zzgl. MwSt.

## Gleitgriff

12<sup>5</sup> 1/2"



VIGOR No.	mm	EAN 4047728+	€
V2573N	250	058391	11,40

## Gleitstück

12<sup>5</sup> 1/2"



VIGOR No.	mm	EAN 4047728+	€
V2667N	43.7	058728	6,65



## Sechskant Steckschlüsseleinsatz



VIGOR No.	SW	L mm	EAN 4047728+	€
V4709N	8 mm	38	058902	4,15
V2465N	10 mm	38	058186	4,15
V2598N	11 mm	38	058629	4,15
V2603N	12 mm	38	058650	4,15
V2599N	13 mm	38	058636	4,15
V2600N	14 mm	38	058643	4,15
V2561N	15 mm	38	058261	4,15
V2562N	16 mm	38	058278	4,15
V2563N	17 mm	38	058285	4,40
V2564N	18 mm	38	058292	4,40

VIGOR No.	SW	L mm	EAN 4047728+	€
V2565N	19 mm	38	058308	4,70
V2566N	20 mm	38	058315	5,05
V2567N	21 mm	38	058322	5,30
V2568N	22 mm	38	058339	5,60
V2569N	23 mm	38	058346	5,95
V2570N	24 mm	38	058353	6,35
V2571N	27 mm	42	058360	8,15
V2572N	30 mm	44	058377	9,35
V2574N	32 mm	44	058384	9,75

## Doppelsechskant Steckschlüsseleinsatz



VIGOR No.	SW	L mm	EAN 4047728+	€
V7512-8	8 mm	38	074339	4,15
V7512-9	9 mm	38	080446	4,15
V7512-10	10 mm	38	074346	4,15
V7512-11	11 mm	38	074353	4,15
V7512-12	12 mm	38	074360	4,15
V7512-13	13 mm	38	074377	4,15
V7512-14	14 mm	38	074384	4,15
V7512-15	15 mm	38	074391	4,15
V7512-16	16 mm	38	074407	4,15
V7512-17	17 mm	38	074414	4,40
V7512-18	18 mm	38	074421	4,40

VIGOR No.	SW	L mm	EAN 4047728+	€
V7512-19	19 mm	38	074438	4,70
V7512-20	20 mm	38	074445	5,05
V7512-21	21 mm	38	074452	5,30
V7512-22	22 mm	38	074469	5,60
V7512-23	23 mm	38	074476	5,95
V7512-24	24 mm	38	074483	6,35
V7512-27	27 mm	42	074490	8,15
V7512-30	30 mm	44	074506	9,35
V7512-32	32 mm	44	074513	9,75
V7512-36	36 mm	46	080477	15,-

## Sechskant Steckschlüsseleinsatz · lang



VIGOR No.	SW	L mm	EAN 4047728+	€
V2579N	10 mm	77	058445	7,40
V2580N	11 mm	77	058452	7,40
V2581N	12 mm	77	058469	6,60
V2584N	13 mm	77	058483	6,60
V2585N	14 mm	77	058490	6,50
V2586N	15 mm	77	058506	6,50
V2587N	16 mm	77	058513	6,85
V2588N	17 mm	77	058520	7,40
V2589N	18 mm	77	058537	7,50
V2590N	19 mm	77	058544	7,80
V2591N	22 mm	77	058551	8,55

## Doppelsechskant Steckschlüsseleinsatz · lang



**NEU**

VIGOR No.	SW	EAN 4047728+	€
V7512L-10	10 mm	080750	6,60
V7512L-11	11 mm	080767	6,60
V7512L-12	12 mm	080774	6,60
V7512L-13	13 mm	080781	6,60
V7512L-14	14 mm	080798	6,60
V7512L-15	15 mm	080804	6,60
V7512L-16	16 mm	080811	6,60
V7512L-17	17 mm	080828	7,40
V7512L-18	18 mm	080835	7,40
V7512L-19	19 mm	080842	7,40
V7512L-22	22 mm	080859	8,80

## T-Profil Steckschlüsseinsatz



VIGOR No.	SW	L mm	EAN 4047728+	€
V2730	E10	38	027304	6,85
V2731	E11	38	027311	6,85
V2732	E12	38	027328	6,85
V2733	E14	38	027335	7,25
V2734	E16	38	027342	7,25
V2196	E18	38	021968	7,80
V2197	E20	38	021975	7,80
V2735	E22	38	027359	7,80
V2592N	E24	38	058568	8,55

## T-Plus Steckschlüsseinsatz



VIGOR No.	SW	EAN 4047728+	€
V7920-EP18	E18+	078238	8,55
V7920-EP20	E20+	078245	8,55
V7920-EP22	E22+	078252	8,55
V7920-EP24	E24+	078269	8,55

## Zündkerzen-Einsatz



VIGOR No.	SW	L mm	EAN 4047728+	€
V2578N	16 mm	66	058438	6,85
V2582N	21 mm	66	058476	8,15

## Multiprofil Steckschlüsseinsatz



VIGOR No.	SW	L mm	EAN 4047728+	€	VIGOR No.	SW	L mm	EAN 4047728+	€
V1988	10 mm	38.1	019880	5,05	V1997	19 mm	38.1	019972	6,35
V1989	11 mm	38.1	019897	5,05	V1998	20 mm	38.1	019989	6,50
V1990	12 mm	38.1	019903	5,05	V1999	21 mm	38.1	019996	7,-
V1991	13 mm	38.1	019910	5,05	V2000	22 mm	38.1	020008	7,-
V1992	14 mm	38.1	019927	5,05	V2001	24 mm	40	020015	8,05
V1993	15 mm	38.1	019934	5,05	V2002	27 mm	42	020022	10,75
V1994	16 mm	38.1	019941	6,35	V2003	30 mm	45	020039	11,40
V1995	17 mm	38.1	019958	6,35	V2004	32 mm	45	020046	11,40
V1996	18 mm	38.1	019965	6,35					



## Innensechskant Schraubendreher-Einsatz



VIGOR No.	SW	L mm	EAN 4047728+	€
V2101	5 mm	55	021012	7,65
V2102	6 mm	55	021029	7,65
V2103	7 mm	55	021036	7,65
V2104	8 mm	55	021043	7,65
V2105	10 mm	55	021050	7,65

VIGOR No.	SW	L mm	EAN 4047728+	€
V2106	12 mm	55	021067	7,65
V2107	14 mm	55	021074	7,65
V2069	17 mm	55	020695	9,45
V2070	19 mm	55	020701	9,45

## Innensechskant Schraubendreher-Einsatz



VIGOR No.	SW	L mm	EAN 4047728+	€
V2072	5 mm	100	020725	8,55
V2073	6 mm	100	020732	8,55
V2074	7 mm	100	020749	8,55
V2075	8 mm	100	020756	8,55

VIGOR No.	SW	L mm	EAN 4047728+	€
V2076	10 mm	100	020763	8,55
V2077	11 mm	100	020770	8,55
V2078	12 mm	100	020787	8,55
V2079	13 mm	100	020794	9,45

## Innensechskant Schraubendreher-Einsatz



VIGOR No.	SW	L mm	EAN 4047728+	€
V2080	5 mm	140	020800	9,45
V2081	6 mm	140	020817	9,45
V2082	7 mm	140	020824	9,45
V2083	8 mm	140	020831	9,45
V2084	10 mm	140	020848	9,45
V2085	12 mm	140	020855	9,45
V2086	14 mm	140	020862	10,35

## Innensechskant Schraubendreher-Einsatz



VIGOR No.	SW	L mm	EAN 4047728+	€
V2087	5 mm	200	020879	10,35
V2088	6 mm	200	020886	10,35
V2089	7 mm	200	020893	10,35
V2090	8 mm	200	020909	10,35
V2091	10 mm	200	020916	10,35
V2092	12 mm	200	020923	10,35

## Innenvielzahn Schraubendreher-Einsatz (XZN)



VIGOR No.	SW	L mm	EAN 4047728+	€
V2094	M5	55	020947	7,65
V2095	M6	55	020954	7,65
V2096	M8	55	020961	7,65
V2097	M9	55	020978	7,65

VIGOR No.	SW	L mm	EAN 4047728+	€
V2098	M10	55	020985	7,65
V2099	M12	55	020992	8,30
V2065	M14	55	020657	8,55
V2100	M16	55	021005	9,45



## Innenvielzahn Schraubendreher-Einsatz (XZN)



VIGOR No.	SW	L mm	EAN 4047728+	€
V2066	M5	100	020664	8,55
V2068	M6	100	020688	8,55
V2067	M8	100	020671	8,55
V2113	M9	100	021135	8,55
V2059	M10	100	020596	8,55
V2060	M12	100	020602	8,55
V2121	M14	100	021210	9,45

## Innenvielzahn Schraubendreher-Einsatz (XZN)



VIGOR No.	SW	L mm	EAN 4047728+	€
V2122	M5	140	021227	9,45
V2124	M6	140	021241	9,45
V2123	M8	140	021234	9,45
V2126	M9	140	021265	9,45
V2128	M10	140	021289	9,45
V2129	M12	140	021296	9,45
V2132	M14	140	021326	10,35

## Innenvielzahn Schraubendreher-Einsatz (XZN)



VIGOR No.	SW	L mm	EAN 4047728+	€
V2133	M8	200	021333	10,35
V2134	M10	200	021340	10,35
V2135	M12	200	021357	10,35
V2137	M14	200	021371	11,50

## T Schraubendreher-Einsatz



VIGOR No.	SW	L mm	EAN 4047728+	€
V2151	T20	55	021517	7,65
V2152	T25	55	021524	7,65
V2153	T27	55	021531	7,65
V2154	T30	55	021548	7,65
V2155	T40	55	021555	7,65

VIGOR No.	SW	L mm	EAN 4047728+	€
V2156	T45	55	021562	7,65
V2157	T50	55	021579	7,65
V2158	T55	55	021586	7,65
V2159	T60	55	021593	7,65
V2160	T70	55	021609	8,55

## T Schraubendreher-Einsatz



VIGOR No.	SW	L mm	EAN 4047728+	€
V2161	T20	100	021616	8,55
V2162	T25	100	021623	8,55
V2163	T27	100	021630	8,55
V2165	T30	100	021654	8,55
V2167	T40	100	021678	8,55

VIGOR No.	SW	L mm	EAN 4047728+	€
V2168	T45	100	021685	8,55
V2169	T50	100	021692	8,55
V2170	T55	100	021708	8,55
V2171	T60	100	021715	8,55
V2172	T70	100	021722	9,45

## T Schraubendreher-Einsatz



VIGOR No.	SW	L mm	EAN 4047728+	€
V2173	T40	140	021739	9,45
V2174	T45	140	021746	9,45
V2175	T50	140	021753	9,45
V2176	T55	140	021760	9,45
V2177	T60	140	021777	9,45
V2178	T70	140	021784	10,35

## T Schraubendreher-Einsatz



VIGOR No.	SW	L mm	EAN 4047728+	€
V2179	T40	200	021791	10,35
V2180	T45	200	021807	10,35
V2181	T50	200	021814	10,35
V2182	T55	200	021821	10,35
V2183	T60	200	021838	10,35
V2184	T70	200	021845	11,50

## T-Plus Schraubendreher-Einsatz



VIGOR No.	SW	EAN 4047728+	€
V7055-IP40	T40+	078344	7,55
V7055-IP45	T45+	078351	7,55
V7055-IP50	T50+	078368	7,55
V7055-IP55	T55+	078375	7,55
V7055-IP60	T60+	078382	7,55

## TR-Plus Schraubendreher-Einsatz



VIGOR No.	SW	EAN 4047728+	€
V7055-IPR40	T40+H	078467	8,15
V7055-IPR45	T45+H	078474	8,15
V7055-IPR50	T50+H	078481	8,15
V7055-IPR55	T55+H	078498	8,15
V7055-IPR60	T60+H	078504	8,15

## T Schraubendreher-Einsatz



VIGOR No.	SW	L mm	EAN 4047728+	€
V7055-T40H	T40H	55	078511	7,55
V7055-T45H	T45H	55	078528	7,55
V7055-T50H	T50H	55	078535	7,55
V7055-T55H	T55H	55	078542	7,55
V7055-T60H	T60H	55	078559	7,55

## RIBE Schraubendreher-Einsatz



VIGOR No.	SW	L mm	EAN 4047728+	€
V2202	M5	55	022026	7,65
V2203	M6	55	022033	7,65
V2204	M7	55	022040	7,65
V2205	M8	55	022057	7,65
V2206	M9	55	022064	7,65

VIGOR No.	SW	L mm	EAN 4047728+	€
V2207	M10	55	022071	7,65
V2208	M12	55	022088	7,65
V2209	M13	55	022095	8,55
V2210	M14	55	022101	8,55

## RIBE Schraubendreher-Einsatz



VIGOR No.	SW	L mm	EAN 4047728+	€
V2211	M5	100	022118	8,55
V2212	M6	100	022125	8,55
V2213	M7	100	022132	8,55
V2214	M8	100	022149	8,55
V2215	M9	100	022156	8,55

VIGOR No.	SW	L mm	EAN 4047728+	€
V2216	M10	100	022163	8,55
V2217	M12	100	022170	8,55
V2218	M13	100	022187	9,45
V2219	M14	100	022194	9,45

## RIBE Schraubendreher-Einsatz



VIGOR No.	SW	L mm	EAN 4047728+	€
V2220	M8	140	022200	9,45
V2221	M9	140	022217	9,45
V2222	M10	140	022224	9,45
V2223	M10.3	140	022231	9,45
V2224	M12	140	022248	10,35
V2225	M13	140	022255	10,35
V2226	M14	140	022262	10,35

## RIBE Schraubendreher-Einsatz



VIGOR No.	SW	L mm	EAN 4047728+	€
V2227	M8	200	022279	10,35
V2228	M9	200	022286	10,35
V2229	M10	200	022293	10,35
V2230	M10.3	200	022309	10,35
V2231	M12	200	022316	10,35
V2232	M13	200	022323	11,50
V2233	M14	200	022330	11,50

## T Kugelkopf Schraubendreher-Einsatz



VIGOR No.	SW	L mm	EAN 4047728+	€
V7055-T20	T20	55	075954	9,15
V7055-T25	T25	55	075961	9,15
V7055-T27	T27	55	075978	9,15
V7055-T30	T30	55	075985	9,15

VIGOR No.	SW	L mm	EAN 4047728+	€
V7055-T40	T40	55	075992	9,15
V7055-T45	T45	55	076005	9,15
V7055-T50	T50	55	076012	9,15
V7055-T55	T55	55	076029	9,15



## T Kugelkopf Schraubendreher-Einsatz



VIGOR No.	SW	L mm	EAN 4047728+	€
V7075-T60	T60	75	076036	9,15
V7075-T70	T70	75	076043	11,10

## T Kugelkopf Schraubendreher-Einsatz



VIGOR No.	SW	L mm	EAN 4047728+	€	VIGOR No.	SW	L mm	EAN 4047728+	€
V7100-T20	T20	100	076050	9,15	V7100-T45	T45	100	076104	9,15
V7100-T25	T25	100	076067	9,15	V7100-T50	T50	100	076234	9,15
V7100-T27	T27	100	076074	9,15	V7100-T55	T55	100	076241	9,15
V7100-T30	T30	100	076081	9,15	V7100-T60	T60	100	076258	11,10
V7100-T40	T40	100	076098	9,15	V7100-T70	T70	100	076265	10,-

## T Kugelkopf Schraubendreher-Einsatz



VIGOR No.	SW	L mm	EAN 4047728+	€
V7140-T40	T40	140	076272	10,-
V7140-T45	T45	140	076289	10,-
V7140-T50	T50	140	076296	10,-
V7140-T55	T55	140	076302	10,-
V7140-T60	T60	140	076319	11,10
V7140-T70	T70	140	076326	11,10

## T Kugelkopf Schraubendreher-Einsatz



VIGOR No.	SW	L mm	EAN 4047728+	€
V7200-T40	T40	200	076333	11,10
V7200-T45	T45	200	076340	11,10
V7200-T50	T50	200	076357	10,80
V7200-T55	T55	200	076364	11,10
V7200-T60	T60	200	076371	11,10
V7200-T70	T70	200	076388	11,10

## Innensechskant Schraubendreher-Einsatz



VIGOR No.	SW	L mm	EAN 4047728+	€
V7055-H5	5 mm	55	076395	8,15
V7055-H6	6 mm	55	076401	8,15
V7055-H7	7 mm	55	076418	8,15
V7055-H8	8 mm	55	076425	8,15
V7055-H10	10 mm	55	076432	8,15
V7055-H12	12 mm	55	076449	8,15
V7055-H14	14 mm	55	076456	8,15

## Innensechskant Schraubendreher-Einsatz

12<sup>5</sup> 1/2"



VIGOR No.	SW	L mm	EAN 4047728+	€
V7075-H17	17 mm	75	076463	10,-
V7075-H19	19 mm	75	076470	11,10

## Innensechskant Schraubendreher-Einsatz

12<sup>5</sup> 1/2"



VIGOR No.	SW	L mm	EAN 4047728+	€	VIGOR No.	SW	L mm	EAN 4047728+	€
V7100-H5	5 mm	100	076487	8,15	V7100-H10	10 mm	100	076548	9,15
V7100-H6	6 mm	100	076517	8,15	V7100-H11	11 mm	100	076555	9,15
V7100-H7	7 mm	100	076524	8,15	V7100-H12	12 mm	100	076562	9,15
V7100-H8	8 mm	100	076531	8,15	V7100-H13	13 mm	100	076579	9,15

## Innensechskant Schraubendreher-Einsatz

12<sup>5</sup> 1/2"



VIGOR No.	SW	L mm	EAN 4047728+	€
V7140-H5	5 mm	140	076586	8,15
V7140-H6	6 mm	140	076593	8,15
V7140-H7	7 mm	140	076609	8,15
V7140-H8	8 mm	140	076616	8,15
V7140-H10	10 mm	140	076623	8,15
V7140-H12	12 mm	140	076630	9,15
V7140-H14	14 mm	140	076647	11,10

## Innensechskant Schraubendreher-Einsatz

12<sup>5</sup> 1/2"



VIGOR No.	SW	L mm	EAN 4047728+	€
V7200-H5	5 mm	200	076654	11,10
V7200-H6	6 mm	200	076661	11,10
V7200-H7	7 mm	200	076678	11,10
V7200-H8	8 mm	200	076685	11,10
V7200-H10	10 mm	200	076692	9,15
V7200-H12	12 mm	200	076708	11,10

## Universalgelenk

12<sup>5</sup> 1/2 12<sup>5</sup> 1/2"



VIGOR No.	L mm	EAN 4047728+	€
V2575N	75	058407	10,25



## Verlängerung

125 1/2" 125 1/2"

VIGOR No.	mm	EAN 4047728+	€
V2576N	125	058414	6,55
V2577N	250	058421	10,85
V4398N	750	058896	49,90

## Schwenkbare Verlängerung

- Befähigung von Schraubverbindungen auf engem Raum und Umgehen von Störkanten
- Kugelförmiger, konischer Außenvierkant

125 1/2" 125 1/2"

VIGOR No.	mm	EAN 4047728+	€
V4317	50	043175	7,45
V4318	75	043182	7,80
V4319	250	043199	13,90

## Adapter

10 3/8" 125 1/2"

VIGOR No.	mm	EAN 4047728+	€
V2109	36	021098	5,35

## Adapter

20 3/4" 125 1/2"

VIGOR No.	mm	EAN 4047728+	€
V2110	46	021104	7,45

## Bit Adapter

8 5/16" 125 1/2"

VIGOR No.	mm	EAN 4047728+	€
V2647N	37	058711	3,75

## Schlagschrauber Steckschlüsseleinsatz · kurz

- Oberfläche: phosphatiert
- Für Maschinenbetätigung

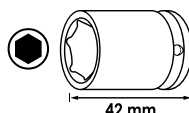
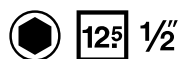

VIGOR No.	SW	EAN 4047728+	€
V5550S-10	10 mm	056175	5,45
V5550S-11	11 mm	056182	5,45
V5550S-12	12 mm	056199	5,45
V5550S-13	13 mm	056205	5,45
V5550S-14	14 mm	056212	5,45
V5550S-15	15 mm	056229	5,45
V5550S-16	16 mm	056236	5,45
V5550S-17	17 mm	056243	5,45
V5550S-18	18 mm	056250	5,60
V5550S-19	19 mm	056267	5,60
V5550S-21	21 mm	056274	6,20
V5550S-22	22 mm	056281	6,20
V5550S-24	24 mm	056298	6,60

## Schlagschrauber Steckschlüsseleinsatz · lang

- Oberfläche: phosphatiert
- Für Maschinenbetätigung

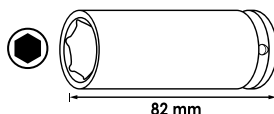
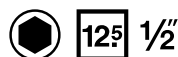

VIGOR No.	SW	EAN 4047728+	€
V5550L-10	10 mm	056045	8,05
V5550L-11	11 mm	056052	8,05
V5550L-12	12 mm	056069	8,05
V5550L-13	13 mm	056076	8,05
V5550L-14	14 mm	056083	8,05
V5550L-15	15 mm	056090	8,05
V5550L-16	16 mm	056106	8,45
V5550L-17	17 mm	056113	8,45
V5550L-18	18 mm	056120	8,45
V5550L-19	19 mm	056137	8,45
V5550L-21	21 mm	056144	9,05
V5550L-22	22 mm	056151	9,45
V5550L-24	24 mm	056168	10,75

## Spiralnutenausdreher-Einsatz

- Betätigung von Muttern mit rundgedrehten Köpfen (Spezialprofil)
- Für Handbetätigung

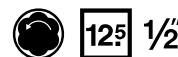

VIGOR No.	SW	L mm	EAN 4047728+	€
V2404N-6	6 mm	50	082327	18,65
V2404N-7	7 mm	50	082334	18,65
V2404N-8	8 mm	50	082341	18,65
V2404N-9	9 mm	50	082358	18,65
V2404N-10	10 mm	50	082365	18,65
V2404N-11	11 mm	50	082372	18,65
V2404N-12	12 mm	50	082389	18,65
V2404N-13	13 mm	50	082396	18,65
V2404N-14	14 mm	50	082402	18,65
V2404N-15	15 mm	50	082419	18,65

VIGOR No.	SW	L mm	EAN 4047728+	€
V2404N-16	16 mm	50	082426	18,65
V2404N-17	17 mm	50	082433	18,65
V2404N-19	19 mm	50	082440	18,65
V2404N-21	21 mm	50	082457	20,70
V2404N-22	22 mm	50	082464	22,-
V2404N-24	24 mm	50	082471	23,40
V2404N-27	27 mm	50	082488	27,55
V2404N-30	30 mm	50	082495	31,70
V2404N-32	32 mm	50	082501	34,90

## Schlagschrauber Schraubendreher-Einsatz

- Oberfläche: phosphatiert
- Für Maschinenbetätigung

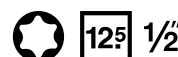

VIGOR No.	SW	L mm	EAN 4047728+	€
V7017-T30	T30	78	066389	12,55
V7017-T40	T40	78	066396	12,55
V7017-T45	T45	78	066402	12,55
V7017-T50	T50	78	066419	12,55
V7017-T55	T55	78	066426	12,55
V7017-T60	T60	78	066242	12,55
V7017-T70	T70	78	066259	12,55
V7017-T80	T80	78	066266	13,70



## Schlagschrauber Schraubendreher-Einsatz

- Oberfläche: phosphatiert
- Für Maschinenbetätigung



VIGOR No.	SW	L mm	EAN 4047728+	€
V7018-M5	M5	78	066273	13,20
V7018-M6	M6	78	066280	13,20
V7018-M8	M8	78	066297	13,20
V7018-M10	M10	78	066303	13,20
V7018-M12	M12	78	066518	13,20
V7018-M14	M14	78	066525	13,20
V7018-M16	M16	78	066532	13,20
V7018-M18	M18	78	066549	14,75

## Schlagschrauber Schraubendreher-Einsatz

- Oberfläche: phosphatiert
- Für Maschinenbetätigung



VIGOR No.	SW	L mm	EAN 4047728+	€
V7019-H5	5 mm	78	066556	12,55
V7019-H6	6 mm	78	066563	12,55
V7019-H8	8 mm	78	066570	12,55
V7019-H10	10 mm	78	066587	12,55
V7019-H12	12 mm	78	066594	12,55
V7019-H14	14 mm	78	066600	12,55
V7019-H17	17 mm	78	066617	12,55
V7019-H19	19 mm	78	066624	12,55

## Schlagschrauber Steckschlüsseleinsatz (Doppel-6kt.) · kurz

- Extra dünnwandiger Steckschlüsseleinsatz für Gelenkwellen-Verschraubungen in der Radnabe
- Bohrung für Sicherungsstift oder Sicherungsfeder und Rille für O-Ring
- Angepasst an gegebene Platzverhältnisse in der Radnabe
- Für z.B.
  - VW Touareg Bj. 2003 →
  - AUDI A4 Bj. 2001 → · A6 Bj. 2005 → · A8 Bj. 2003 → · Q7 Bj. 2007 →
  - Weitere Modelle
- Für Maschinenbetätigung

● 32 mm

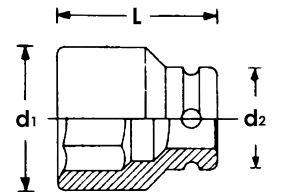

VIGOR No.	d1 mm	d2 mm	SW	L mm	EAN 4047728+	€
V4477	44.4	30	32 mm	50	044776	17,20

## Schlagschrauber Steckschlüsseleinsatz (Doppel-6kt.) · kurz

- Extra dünnwandiger Steckschlüsseleinsatz für Gelenkwellen-Verschraubungen in der Radnabe
- Bohrung für Sicherungsstift oder Sicherungsfeder und Rille für O-Ring
- Angepasst an gegebene Platzverhältnisse in der Radnabe
- Für z.B.: OPEL Corsa D Bj. 2006 → · Adam Bj. 2012 → · Mokka Bj. 2012 → · CHEVROLET/GMC Trax Bj. 2013 →
- Weitere Modelle
- Ebenfalls für BMW · SEAT und VW Fahrzeuge
- Für Maschinenbetätigung

● 36 mm

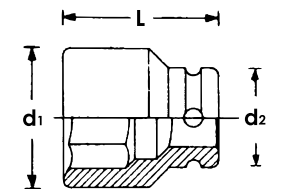

VIGOR No.	d1 mm	d2 mm	SW	L mm	EAN 4047728+	€
V4478	46.9	30	36 mm	50	044783	19,25



**V2318N**, EAN 4047728**059299**

## Steckschlüssel Satz

- 24 Zähne
- 15° Betätigungswinkel
- Für Handbetätigung

20 3/4"

21

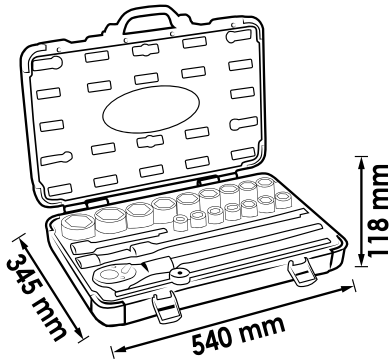

xx			Ausführung	SW
16 x	20 3/4"			19 · 21 · 22 · 23 · 24 · 26 · 27 · 28 · 30 · 32 · 34 · 36 · 38 · 41 · 46 · 50 mm
1 x	-	20 3/4"		500 mm
1 x	20 3/4"	20 3/4"		100 mm
1 x	20 3/4"	20 3/4"		200 mm
1 x	20 3/4"	20 3/4"		400 mm
1 x	-	20 3/4"		450 mm

**336,50 €**  
zzgl. MwSt.

## Umschaltknarre

- 24 Zähne
- 15° Betätigungswinkel
- Für Handbetätigung

20 3/4"



VIGOR No.	mm	EAN 4047728+	€
V2319N	500	059282	107,-

## Gleitgriff

- Für Handbetätigung

20 3/4"



VIGOR No.	mm	EAN 4047728+	€
V2322N	450	057158	37,85

## Adapter

12<sup>5</sup> 1/2" 20 3/4"



VIGOR No.	mm	EAN 4047728+	€
V2111	50	021111	14,45



## Verlängerung

20 3/4" 20 3/4"



VIGOR No.	mm	EAN 4047728+	€
V2320N	100	057561	19,50
V2321N	200	057578	23,80
V2317N	400	057554	31,45

## Steckschlüsseinsatz

20 3/4"



VIGOR No.	SW	mm	EAN 4047728+	€
V2323N	19 mm	50	057165	12,25
V2324N	21 mm	50	057172	12,25
V2325N	22 mm	50	057189	12,25
V2326N	23 mm	50	057196	12,25
V2327N	24 mm	50	057202	12,25
V2328N	26 mm	50	057615	12,25
V2329N	27 mm	52	057622	14,40
V2256N	28 mm	52	057059	16,-
V2924N	30 mm	54	057639	23,90
V2331N	32 mm	56	057646	17,65
V2332N	34 mm	58	057653	21,-
V2333N	36 mm	58	057677	22,95
V2334N	38 mm	60	057684	22,95
V2337N	41 mm	64	057721	24,75
V2336N	46 mm	68	057707	26,05
V2335N	50 mm	68	057691	27,85

## V5024, EAN 4047728050241

### Schlagschrauber Steckschlüsseinsatz Satz

20 3/4" 4

- Extra dünnwandige Steckschlüssel-Einsätze für Antriebswellen-Verschraubungen in der Radnabe
- Angepasst an gegebene Platzverhältnisse in der Radnabe
- Unter anderem für:
  - SW 24: VW Touran Bj. 2006 →
  - SW 30: VW Passat C, Golf 4, Polo, New Beetle · AUDI TT · ŠKODA Octavia, Superb, Fabia
  - SW 32: VW Touareg Bj. 2003 →
  - SW 36: BMW 3er · 5er · 7er · SEAT Ibiza · VW Polo, Golf Plus · OPEL Corsa D · Adam · Mokka · CHEVROLET Trax Bj. → 2013 · FIAT 500 · Grande Punto · Punto Evo Bj. → 2005 · FORD Ka · MERCEDES-BENZ S-Klasse · JAGUAR XJ40 · XJ181
- Für Maschinenbetätigung



VIGOR No.	d1 mm	d2 mm	SW	mm	EAN 4047728+	€
V5025	44.3	35	24 mm	44	050258	25,80
V5026	44.3	42	30 mm	50	050265	26,75
V5182	44.3	44.3	32 mm	50	051828	28,-
V5183	44.3	46.9	36 mm	50	051835	30,30

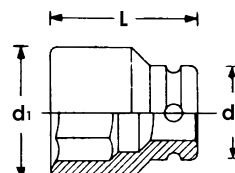

**119,- €** zzgl. MwSt.

**V7212**, EAN 4047728072120

## Schlagschrauber Schraubendreher-Einsatz Satz

- Gängige Verschraubungen VAG  
Fahrzeuge, z.B. Bremsträger, zentrale  
Antriebswellen, Stoßdämpfer oder  
geschraubte Radlagereinheiten
- Oberfläche: brüniert, geölt
- Für Maschinenbetätigung

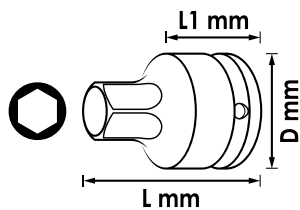
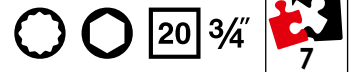

VIGOR No.	d2 mm	SW	L1 mm	L mm	EAN 4047728+	€
V7212-H14	44	14 mm	30	60	072168	32,40
V7212-H17	44	17 mm	30	60	072175	32,40
V7212-H19	44	19 mm	30	60	072182	32,40
V7212-H21	44	21 mm	30	60	072199	32,40
V7212-M14	44	M14	30	60	072137	32,40
V7212-M16	44	M16	30	60	072144	32,40
V7212-M18	44	M18	30	60	072151	32,40

**115,50 €**  
zzgl. MwSt.

**V5505**, EAN 4047728055055

## Schlagschrauber Gelenkstück Satz

- Arbeiten an schwer zugänglichen Stellen,  
sowie zur Umgehung von Störkanten
- Bohrung für Sicherungssift oder  
Sicherungsfeder und Rille für O-Ring
- Für Maschinenbetätigung

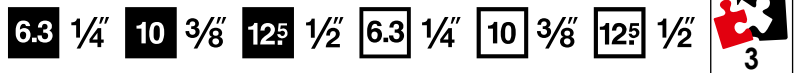

VIGOR No.	EAN 4047728+	€
V5505-1/4	055062	11,55
V5505-3/8	055079	14,05
V5505-1/2	055086	16,80

**43,20 €**  
zzgl. MwSt.



**V1293**, EAN 4047728012935







## Adapter Satz

• Für Handbetätigung

6.3 1/4 10 3/8 12.5 1/2 20 3/4   
6.3 1/4 10 3/8 12.5 1/2 20 3/4



Einzelteilaufistung ab Seite 131



XX	■		Ausführung	SW
1 x	6.3 1/4	10 3/8		26 mm
1 x	10 3/8	6.3 1/4		27 mm
1 x	10 3/8	12.5 1/2		36 mm
1 x	12.5 1/2	10 3/8		36 mm
1 x	12.5 1/2	20 3/4		46 mm
1 x	20 3/4	12.5 1/2		50 mm

**39,60 €**  
zzgl. MwSt.

**V2687**, EAN 4047728026871

## T Steckschlüsseinsatz Satz

• Für Handbetätigung

 6.3 1/4 10 3/8 12.5 1/2   
6.3 1/4 10 3/8 12.5 1/2



Einzelteilaufistung ab Seite 127

XX	■		Ausführung	SW
7 x	6.3 1/4			E4 · E5 · E6 · E7 · E8 · E10 · E11
12 x	10 3/8			E4 · E5 · E6 · E7 · E8 · E10 · E11 · E12 · E14 · E16 · E18 · E20
9 x	12.5 1/2			E10 · E11 · E12 · E14 · E16 · E18 · E20 · E22 · E24

**82,90 €**  
zzgl. MwSt.

# Steckschlüssel Systeme



**V1781**, EAN 4047728**017817**  
**T Steckschlüsseinsatz Satz**  
 • Für Handbetätigung

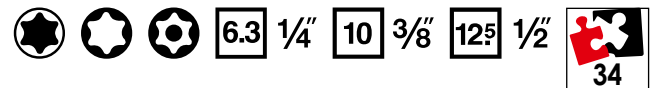

Einzelteilaufistung ab Seite 127

XX	■	⊙	Ausführung	SW
5 x	6.3 1/4	⊙		E4 · E5 · E6 · E7 · E8
1 x	6.3 1/4	⊕		T27
5 x	6.3 1/4	⊕		T9H · T10H · T15H · T25H · T30H
4 x	10 3/8	⊙		E10 · E12 · E14 · E16
4 x	10 3/8	⊕		T40 · T45 · T47 · T50
2 x	10 3/8	⊕		T45H · T50H
2 x	12.5 1/2	⊙		E18 · E20
2 x	12.5 1/2	⊕		T55 · T60
1 x	12.5 1/2	⊕		T55H

**74,40 €**  
 zzgl. MwSt.



**V1706N**, EAN 4047728**056465**

**Steckschlüssel Satz**

• Für Handbetätigung



**179,-€**  
zzgl. MwSt.

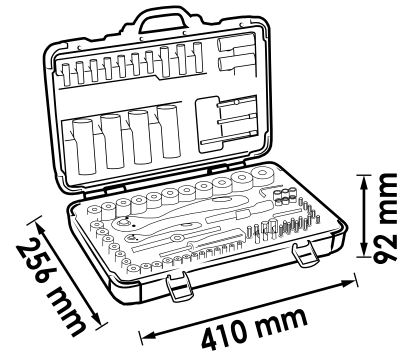

Einzelteilaufistung ab Seite 124

XX	■		Ausführung	SW
4 x	8 5/16	⊕		T40 · T45 · T50 · T55
4 x	8 5/16	○		8 · 10 · 12 · 14 mm
2 x	8 5/16	⊕		PH3 · PH4
2 x	8 5/16	⊕		PZ3 · PZ4
3 x	8 5/16	⊖		1.6x8 · 2x12 · 1.6x10 mm
1 x	-	○		2 mm
1 x	6.3 1/4	6.3 1/4		25 mm
1 x	12.5 1/2	8 5/16		37 mm
1 x	-	6.3 1/4		150 mm
1 x	6.3 1/4	6.3 1/4		110 mm
1 x	-	12.5 1/2		43.7 mm
4 x	6.3 1/4	○		3 · 4 · 5 · 6 mm
3 x	6.3 1/4	⊖		0.8x4 · 1x5.5 · 1.2x7 mm
2 x	6.3 1/4	⊕		PH1 · PH2
2 x	6.3 1/4	⊕		PZ1 · PZ2

XX	■		Ausführung	SW
5 x	6.3 1/4	⊕		T10 · T15 · T20 · T25 · T30
18 x	12.5 1/2	●		10 · 11 · 12 · 13 · 14 · 15 · 16 · 17 · 18 · 19 · 20 · 21 · 22 · 23 · 24 · 27 · 30 · 32 mm
4 x	12.5 1/2	●		14 · 15 · 17 · 19 mm
13 x	6.3 1/4	●		4 · 4.5 · 5 · 5.5 · 6 · 7 · 8 · 9 · 10 · 11 · 12 · 13 · 14 mm
8 x	6.3 1/4	●		6 · 7 · 8 · 9 · 10 · 11 · 12 · 13 mm
1 x	-	6.3 1/4		150 mm
1 x	-	12.5 1/2		250 mm
1 x	6.3 1/4	6.3 1/4		40 mm
1 x	12.5 1/2	12.5 1/2		75 mm
1 x	6.3 1/4	6.3 1/4		50 mm
1 x	6.3 1/4	6.3 1/4		100 mm
1 x	6.3 1/4	6.3 1/4		145 mm
1 x	12.5 1/2	12.5 1/2		125 mm
1 x	12.5 1/2	12.5 1/2		250 mm
2 x	12.5 1/2	●		16 · 21 mm

# Steckschlüssel Systeme



V2461N, EAN 4047728056472

Steckschlüssel Satz

• Für Handbetätigung

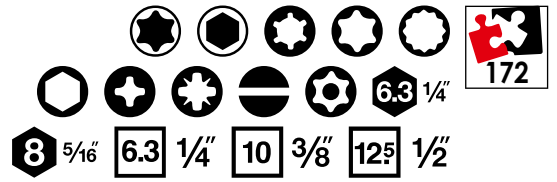

**192,-€**  
zzgl. MwSt.

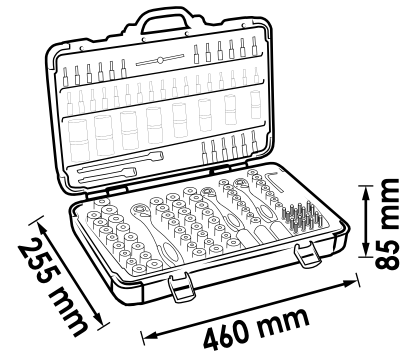

Einzelteilaufistung ab Seite 124

XX	■		Ausführung	SW
5 x	6.3 1/4	⊛		R5 · R6 · R7 · R8 · R9
3 x	6.3 1/4	⊛		T5 · T6 · T7
3 x	6.3 1/4	○		M5 · M6 · M8
9 x	6.3 1/4	⊛		T7H · T10H · T15H · T20H · T25H · T27H · T30H · T40H · T45H
6 x	8 5/16	⊛		T40 · T45 · T50 · T55 · T60 · T70
5 x	8 5/16	○		7 · 8 · 10 · 12 · 14 mm
2 x	8 5/16	⊕		PH3 · PH4
2 x	8 5/16	⊕		PZ3 · PZ4
3 x	8 5/16	⊖		1.6x8 · 1.6x10 · 2x12 mm
6 x	8 5/16	⊛		T40H · T45H · T50H · T55H · T60H · T70H
2 x	-	○		1.3 · 2 mm
1 x	6.3 1/4	6.3 1/4		25 mm
1 x	10 3/8	8 5/16		28 mm
1 x	12.5 1/2	8 5/16		37 mm
1 x	-	6.3 1/4		150 mm
1 x	6.3 1/4	6.3 1/4		110 mm
1 x	-	12.5 1/2		43.7 mm
4 x	6.3 1/4	○		3 · 4 · 5 · 6 mm
4 x	6.3 1/4	⊖		0.8x4 · 1x5.5 · 1.2x6.5 · 1.2x7 mm
3 x	6.3 1/4	⊕		PH0 · PH1 · PH2
3 x	6.3 1/4	⊕		PZ0 · PZ1 · PZ2
8 x	6.3 1/4	⊛		T8 · T9 · T10 · T15 · T20 · T25 · T27 · T30
7 x	6.3 1/4	⊛		T8H · T9H · T10H · T15H · T25H · T27H · T30H

XX	■		Ausführung	SW
6 x	10 3/8	⊛		E10 · E11 · E12 · E14 · E16 · E18
6 x	10 3/8	○		10 · 11 · 12 · 13 · 14 · 15 mm
10 x	10 3/8	○		10 · 11 · 12 · 13 · 14 · 15 · 16 · 17 · 18 · 19 mm
17 x	12.5 1/2	○		10 · 11 · 12 · 13 · 14 · 15 · 16 · 17 · 18 · 19 · 20 · 21 · 22 · 24 · 27 · 30 · 32 mm
5 x	12.5 1/2	○		16 · 17 · 18 · 19 · 22 mm
2 x	12.5 1/2	⊛		E20 · E22
13 x	6.3 1/4	○		4 · 4.5 · 5 · 5.5 · 6 · 7 · 8 · 9 · 10 · 11 · 12 · 13 · 14 mm
7 x	6.3 1/4	○		4 · 5 · 6 · 7 · 8 · 9 · 10 mm
5 x	6.3 1/4	⊛		E4 · E5 · E6 · E7 · E8
1 x	-	6.3 1/4		150 mm
1 x	-	10 3/8		198 mm
1 x	-	12.5 1/2		250 mm
1 x	6.3 1/4	6.3 1/4		40 mm
1 x	10 3/8	10 3/8		50 mm
1 x	12.5 1/2	12.5 1/2		75 mm
1 x	6.3 1/4	6.3 1/4		50 mm
1 x	6.3 1/4	6.3 1/4		100 mm
1 x	10 3/8	10 3/8		125 mm
1 x	12.5 1/2	12.5 1/2		125 mm
1 x	12.5 1/2	12.5 1/2		250 mm
1 x	10 3/8	○		18 mm
2 x	12.5 1/2	○		16 · 21 mm

**V3277N**, EAN 4047728056489

**Steckschlüssel Satz**

• Für Handbetätigung



**306,- €**  
zzgl. MwSt.

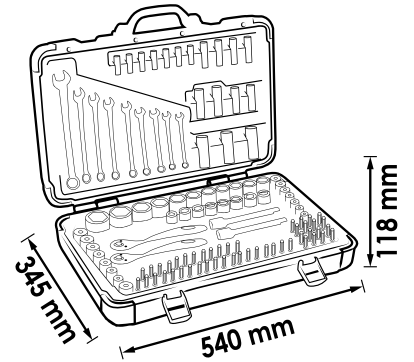

**Einzelteilliste ab Seite 124**

XX	■		Ausführung	SW
3 x	6.3 1/4	+		PH1 · PH2 · PH3
3 x	6.3 1/4	+		PZ1 · PZ2 · PZ3
3 x	6.3 1/4	●		1x5.5 · 1x6 · 1.6x8 mm
5 x	6.3 1/4	○		3 · 4 · 5 · 6 · 7 mm
6 x	6.3 1/4	+		T15H · T20H · T25H · T27H · T30H · T40H
10 x	6.3 1/4	+		T10 · T15 · T20 · T25 · T27 · T30 · T40 · T45 · T8 · T9
4 x	8 5/16	○		7 · 8 · 10 · 12 mm
3 x	8 5/16	●		1.6x8 · 1.6x10 · 2x12 mm
3 x	8 5/16	+		PH2 · PH3 · PH4
3 x	8 5/16	+		PZ2 · PZ3 · PZ4
5 x	8 5/16	+		T40 · T45 · T50 · T55 · T60
5 x	8 5/16	+		T40H · T45H · T50H · T55H · T60H
4 x	8 5/16	+		R10 · R11 · R12 · R13
2 x	8 5/16	○		M10 · M12
1 x	-	6.3 1/4		200 mm
2 x	-	○		1.3 · 2 mm
12 x	-	●		8 · 9 · 10 · 11 · 12 · 13 · 14 · 15 · 17 · 19 · 22 · 24 mm
1 x	10 3/8	8 5/16		28 mm
1 x	12.5 1/2	8 5/16		37 mm
1 x	6.3 1/4	6.3 1/4		25 mm
1 x	-	6.3 1/4		150 mm
10 x	10 3/8	●		11 · 10 · 12 · 13 · 14 · 15 · 16 · 17 · 18 · 19 mm

XX	■		Ausführung	SW
6 x	10 3/8	+		E18 · E16 · E14 · E12 · E11 · E10
6 x	10 3/8	●		10 · 11 · 12 · 13 · 14 · 15 mm
14 x	12.5 1/2	●		13 · 14 · 15 · 16 · 17 · 18 · 19 · 20 · 21 · 22 · 24 · 27 · 30 · 32 mm
3 x	12.5 1/2	+		E24 · E22 · E20
5 x	12.5 1/2	●		16 · 17 · 18 · 19 · 22 mm
13 x	6.3 1/4	●		4 · 4.5 · 5 · 5.5 · 6 · 7 · 8 · 9 · 10 · 11 · 12 · 13 · 14 mm
5 x	6.3 1/4	+		E8 · E7 · E6 · E5 · E4
7 x	6.3 1/4	●		4 · 5 · 6 · 7 · 8 · 9 · 10 mm
1 x	-	6.3 1/4		150 mm
1 x	-	10 3/8		198 mm
1 x	-	12.5 1/2		250 mm
1 x	12.5 1/2	12.5 1/2		75 mm
1 x	10 3/8	10 3/8		50 mm
1 x	6.3 1/4	6.3 1/4		40 mm
1 x	12.5 1/2	12.5 1/2		125 mm
1 x	10 3/8	10 3/8		125 mm
1 x	6.3 1/4	6.3 1/4		100 mm
1 x	6.3 1/4	6.3 1/4		50 mm
1 x	12.5 1/2	12.5 1/2		250 mm
2 x	12.5 1/2	●		21 · 16 mm
1 x	10 3/8	●		18 mm



# Steckschlüssel Systeme



V5461, EAN 4047728080323

Steckschlüssel Satz

• Für Handbetätigung



**NEU**

**120,- €**  
zzgl. MwSt.

Doppelsechskant-  
Ausführung



## Einzelteilliste ab Seite 126

XX	■		Ausführung	SW
13 x	6.3 1/4	●		4 · 4.5 · 5 · 5.5 · 6 · 7 · 8 · 9 · 10 · 11 · 12 · 13 · 14 mm
11 x	10 3/8	●		9 · 10 · 11 · 12 · 13 · 14 · 15 · 16 · 17 · 18 · 19 mm
20 x	12.5 1/2	●		9 · 10 · 11 · 12 · 13 · 14 · 15 · 16 · 17 · 18 · 19 · 20 · 21 · 22 · 23 · 24 · 27 · 30 · 32 · 36 mm
11 x	6.3 1/4	●		4 · 5 · 5.5 · 6 · 7 · 8 · 9 · 10 · 11 · 12 · 13 mm
11 x	10 3/8	●		9 · 10 · 11 · 12 · 13 · 14 · 15 · 16 · 17 · 18 · 19 mm
11 x	12.5 1/2	●		10 · 11 · 12 · 13 · 14 · 15 · 16 · 17 · 18 · 19 · 22 mm
5 x	6.3 1/4	●		E4 · E5 · E6 · E7 · E8
6 x	10 3/8	●		E10 · E11 · E12 · E14 · E16 · E18
3 x	12.5 1/2	●		E20 · E22 · E24
4 x	6.3 1/4	○		3 · 4 · 5 · 6 mm
4 x	6.3 1/4	◐		0.8x4 · 1x5.5 · 1.2x6.5 · 1.2x7 mm
3 x	6.3 1/4	+		PH0 · PH1 · PH2
3 x	6.3 1/4	⊕		PZ0 · PZ1 · PZ2

XX	■		Ausführung	SW
8 x	6.3 1/4	⊕		T8 · T9 · T10 · T15 · T20 · T25 · T27 · T30
8 x	6.3 1/4	⊕		T8H · T9H · T10H · T15H · T20H · T25H · T27H · T30H
1 x	6.3 1/4	6.3 1/4		40 mm
1 x	10 3/8	10 3/8		50 mm
1 x	12.5 1/2	12.5 1/2		75 mm
1 x	-	6.3 1/4		150 mm
1 x	6.3 1/4	6.3 1/4		110 mm
1 x	-	12.5 1/2		43.7 mm
1 x	6.3 1/4	6.3 1/4		50 mm
1 x	6.3 1/4	6.3 1/4		100 mm
1 x	10 3/8	10 3/8		125 mm
1 x	12.5 1/2	12.5 1/2		125 mm
1 x	12.5 1/2	12.5 1/2		250 mm



V4425N, EAN 4047728058919

Werkzeugkoffer · universal



**323,- €**  
zzgl. MwSt.



### Einzelteilaufistung ab Seite 124

XX	■	■	Ausführung	SW
12 x	-	●●	8 · 9 · 10 · 11 · 12 · 13 · 14 · 15 · 16 · 17 · 18 · 19 mm	
4 x	-	●	0.6x3 · 0.8x4 · 1x5.5 · 1.2x6.5 mm	
3 x	-	+	PH0 · PH1 · PH2	
1 x	-	-	90 mm	
1 x	-	-	160 mm	
1 x	-	-	200 mm	
1 x	-	-	300 g	
1 x	6.3 1/4	6.3 1/4	100 mm	
1 x	6.3 1/4	6.3 1/4	40 mm	
11 x	6.3 1/4	●	4 · 5 · 5.5 · 6 · 7 · 8 · 9 · 10 · 11 · 12 · 13 mm	
1 x	125 1/2	125 1/2	125 mm	

XX	■	■	Ausführung	SW
1 x	125 1/2	125 1/2	75 mm	
16 x	125 1/2	●	10 · 11 · 12 · 13 · 14 · 15 · 16 · 17 · 19 · 20 · 21 · 22 · 24 · 27 · 30 · 32 mm	
4 x	6.3 1/4	○	3 · 4 · 5 · 6 mm	
3 x	6.3 1/4	●	0.8x4 · 1x5.5 · 1.2x6.5 mm	
3 x	6.3 1/4	+	PH1 · PH2 · PH3	
3 x	6.3 1/4	✦	PZ1 · PZ2 · PZ3	
6 x	6.3 1/4	✦	T10 · T15 · T20 · T25 · T30 · T40	
1 x	-	6.3 1/4	150 mm	
1 x	-	125 1/2	250 mm	
9 x	-	○	1.5 · 2 · 2.5 · 3 · 4 · 5 · 6 · 8 · 10	
9 x	-	○	T10 · T15 · T20 · T25 · T27 · T30 · T40 · T45 · T50	

# Universal Werkzeugkoffer



**V2542**, EAN 4047728**025423**

Werkzeugkoffer · universal

• Werkzeug-Koffer inklusive Sortiment



VIGOR No.	Bezeichnung	Länge x Breite x Höhe mm	EAN 4047728+	€
V2400	Koffer · leer	510x410x140	024006	70,25
V2464	Weichschaum-Einlage · leer		024648	37,75

**478,50 €**  
zzgl. MwSt.

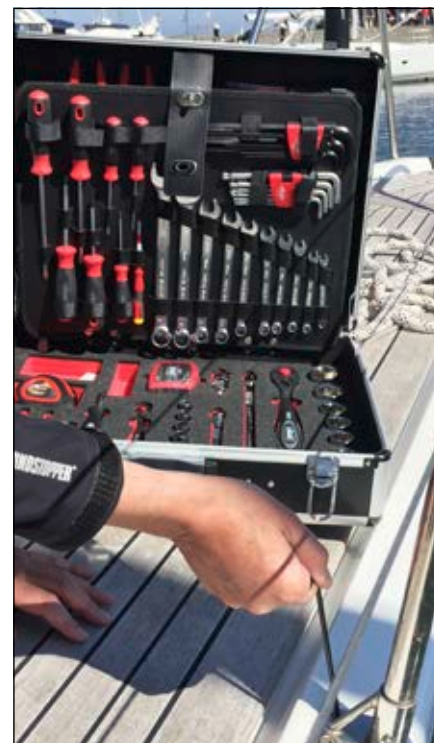

## Doppel-Maulschlüssel

- Sicherer Halt bei öligten Händen dank Anti-Rutsch-Oberfläche
- Oberfläche: mattverchromt
- DIN 3110

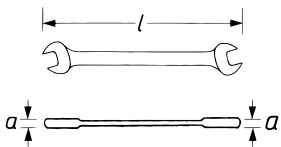

VIGOR No.	a mm	SW	mm	EAN 4047728+	€
V1461N-6X7	3.4	6x7 mm	126	064903	2,45
V1461N-8X9	3.6	8x9 mm	142	064187	2,45
V1461N-10X11	4.5	10x11 mm	157	064200	2,95
V1461N-12X13	5.1	12x13 mm	170	064231	3,25
V1461N-14X15	5.4	14x15 mm	187	064262	3,50
V1461N-16X17	6	16x17 mm	202	064286	3,85
V1461N-18X19	7.3	18x19 mm	220	064309	4,75
V1461N-20X22	7.3	20x22 mm	232	064026	5,90
V1461N-21X23	7.5	21x23 mm	246	064033	6,45
V1461N-24X27	8.4	24x27 mm	265	064064	8,20
V1461N-25X28	8.5	25x28 mm	275	064071	10,-
V1461N-30X32	9.2	30x32 mm	298	064095	11,80

## V1461N, EAN 4047728064934

### Doppel-Maulschlüssel Satz

- Sicherer Halt bei öligten Händen dank Anti-Rutsch-Oberfläche
- Oberfläche: mattverchromt
- DIN 3110



**75,60 €**  
zzgl. MwSt.

XX	Ausführung	SW
12 x		6x7 · 8x9 · 10x11 · 12x13 · 14x15 · 16x17 · 18x19 · 20x22 · 21x23 · 24x27 · 25x28 · 30x32 mm

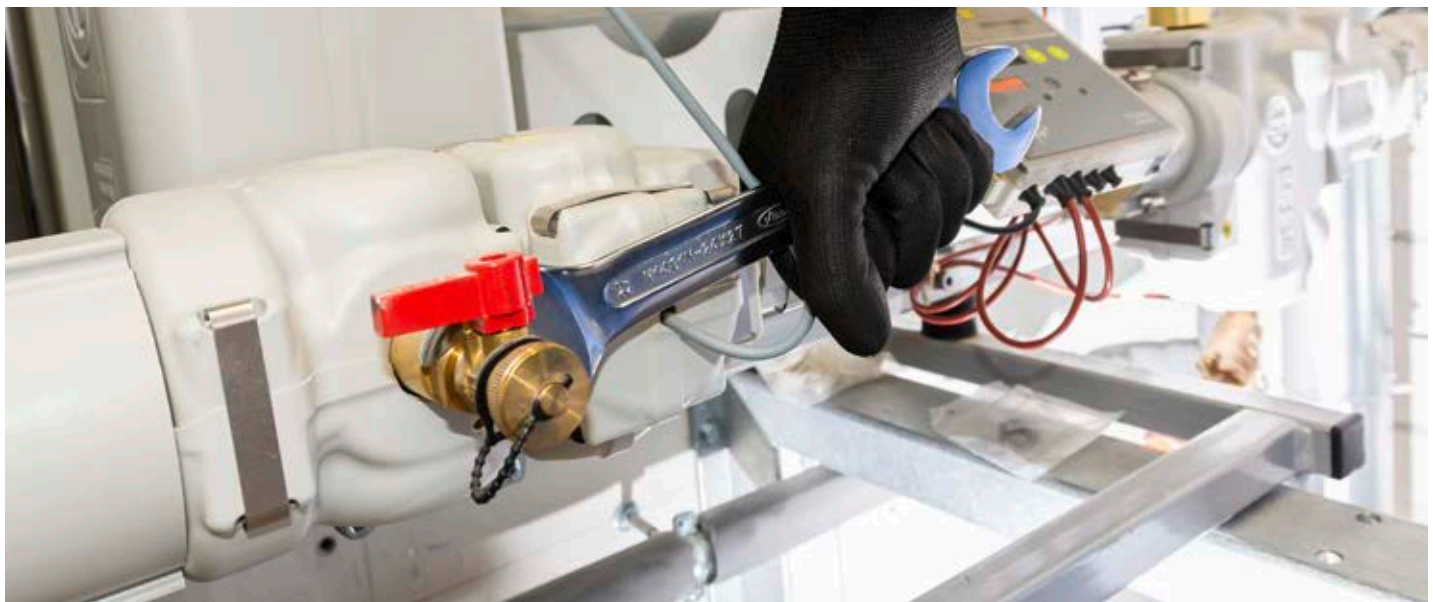

## Ring-Maulschlüssel

- Lange Ausführung
- 15° gekröpfter Ringschlüssel
- Sicherer Halt bei öligen Händen dank Anti-Rutsch-Oberfläche
- Oberfläche: mattverchromt
- DIN 3113 Form A, ISO 7738

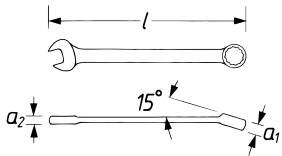

VIGOR No.	a1 mm	a2 mm	SW	l mm	EAN 4047728+	€
V4473N-6	4.8	3.4	6 mm	100	064439	2,40
V4473N-7	5.4	3.5	7 mm	110	064446	2,50
V4473N-8	5.5	3.8	8 mm	115	064453	2,60
V4473N-9	6	4	9 mm	125	064460	2,70
V4473N-10	6.3	4.5	10 mm	135	064477	2,80
V4473N-11	6.8	4.9	11 mm	145	064484	2,90
V4473N-12	7.2	5	12 mm	155	064491	3,20
V4473N-13	8.3	5.6	13 mm	165	064507	3,40
V4473N-14	8.5	5.7	14 mm	171	064514	3,80
V4473N-15	9.2	6.1	15 mm	185	064323	4,10
V4473N-16	9.3	6.5	16 mm	195	064569	4,85
V4473N-17	9.6	6.8	17 mm	210	064576	4,95
V4473N-18	10.1	7.2	18 mm	220	064583	5,45
V4473N-19	10.2	7.3	19 mm	230	064590	5,85
V4473N-20	10.8	7.4	20 mm	240	064606	5,95
V4473N-21	11.1	7.6	21 mm	245	064613	6,35
V4473N-22	11.7	7.9	22 mm	248	064408	7,15
V4473N-24	12.8	8.4	24 mm	270	064712	9,15
V4473N-27	13.9	9.1	27 mm	300	064736	12,10
V4473N-30	15.2	9.9	30 mm	330	064743	13,60
V4473N-32	15.9	10.2	32 mm	350	064750	16,05
V4473N-36	19.3	11.6	36 mm	400	064767	19,80

## V4472N, EAN 4047728064958

### Ring-Maulschlüssel Satz

- Lange Ausführung
- 15° gekröpfter Ringschlüssel
- Sicherer Halt bei öligen Händen dank Anti-Rutsch-Oberfläche
- Oberfläche: mattverchromt
- DIN 3113 Form A, ISO 7738



**54,45 €**  
zzgl. MwSt.

XX	Ausführung	SW
15 x		6 · 7 · 8 · 9 · 10 · 11 · 12 · 13 · 14 · 15 · 16 · 17 · 18 · 19 · 22 mm

## V4473N, EAN 4047728064965

### Ring-Maulschlüssel Satz

- Lange Ausführung
- 15° gekröpfter Ringschlüssel
- Sicherer Halt bei öligen Händen dank Anti-Rutsch-Oberfläche
- Oberfläche: mattverchromt
- DIN 3113 Form A, ISO 7738



**97,80 €**  
zzgl. MwSt.

XX	Ausführung	SW
22 x		6 · 7 · 8 · 9 · 10 · 11 · 12 · 13 · 14 · 15 · 16 · 17 · 18 · 19 · 20 · 21 · 22 · 24 · 27 · 30 · 32 · 36 mm



## Doppel-Ringschlüssel

- 15° gekröpft
- Sicherer Halt bei öligten Händen dank Anti-Rutsch-Oberfläche
- Oberfläche: verchromt, poliert
- DIN 838, ISO 10104

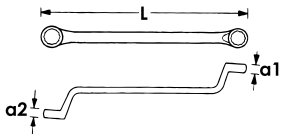

VIGOR No.	a1 mm	a2 mm	SW	L mm	EAN 4047728+	€
V1524N-6X7	5.8	5	6 x 7 mm	175	064774	2,80
V1524N-8X9	7.7	6.7	8 x 9 mm	185	064781	3,45
V1524N-10X11	8.4	7.4	10 x 11 mm	198	064798	3,90
V1524N-12X13	8.4	9.1	12 x 13 mm	215	064804	4,75
V1524N-14X15	10.4	9.5	14 x 15 mm	228	064811	5,25
V1524N-16X17	10.8	10	16 x 17 mm	246	064828	5,80
V1524N-18X19	12.1	10.8	18 x 19 mm	268	064835	6,35
V1524N-20X22	12.5	11.7	20 x 22 mm	292	064842	7,-
V1524N-21X23	13.2	12.2	21 x 23 mm	315	064859	8,70
V1524N-24X27	13.4	12.2	24 x 27 mm	328	064866	10,-
V1524N-25X28	14.9	13.9	25 x 28 mm	342	064873	13,40
V1524N-30X32	16	15.2	30 x 32 mm	370	064880	14,05

## V1524N, EAN 4047728064910

### Doppel-Ringschlüssel Satz

- 15° gekröpft
- Sicherer Halt bei öligten Händen dank Anti-Rutsch-Oberfläche
- Oberfläche: verchromt, poliert
- DIN 838, ISO 10104



**73,95 €**  
zzgl. MwSt.

12 x	Ausführung	SW
		6 x 7 · 8 x 9 · 10 x 11 · 12 x 13 · 14 x 15 · 16 x 17 · 18 x 19 · 20 x 22 · 21 x 23 · 24 x 27 · 25 x 28 · 30 x 32 mm

## Ratschen-Ring-Maulschlüssel · kurz

- 72 Zähne
- 5° Betätigungswinkel

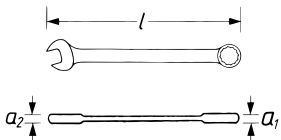

VIGOR No.	a1 mm	a2 mm	SW	L mm	EAN 4047728+	€
V2822	7.4	4.9	8 mm	89	028226	12,10
V2823	7.5	5.2	9 mm	93	028233	12,10
V2824	8.5	5.5	10 mm	97	028240	12,60
V2825	8.4	6.1	11 mm	102	028257	12,60
V2826	8.5	6.3	12 mm	106	028264	13,10
V2827	8.4	6.7	13 mm	110	028271	13,10
V2828	8.4	7	14 mm	114	028288	14,-
V2829	8.4	7.4	15 mm	120	028295	15,15
V2830	10	7.7	16 mm	122	028301	15,15
V2831	10	7.7	17 mm	126	028318	17,15
V2832	11.5	8.4	18 mm	131	028325	18,15
V2833	11.5	8.6	19 mm	136	028332	18,65

## V2821, EAN 4047728028219

### Ratschen-Ring-Maulschlüssel Satz · kurz

- Lieferung in Rolltasche
- 72 Zähne
- 5° Betätigungswinkel



**152,- €**  
zzgl. MwSt.

12 x	Ausführung	SW
		8 · 9 · 10 · 11 · 12 · 13 · 14 · 15 · 16 · 17 · 18 · 19 mm

# Schraubenschlüssel



## Ratschen-Ring-Maulschlüssel · lang

- Oberfläche: verchromt, poliert
- 72 Zähne
- 5° Betätigungswinkel

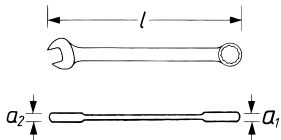

VIGOR No.	a1 mm	a mm	SW	L mm	EAN 4047728+	€
V3635	7.4	4.6	6 mm	135	036351	11,40
V3636	7.4	4.7	7 mm	144	036368	11,40
V1008	7.4	4.7	8 mm	140	010085	12,10
V1009	7.4	5.3	9 mm	151	010092	12,10
V1010	8.4	5.7	10 mm	160	010108	13,10
V1021	8.4	6.1	11 mm	165	010214	13,10
V1022	8.4	6.4	12 mm	170	010221	13,60
V1023	8.4	6.6	13 mm	177	010238	14,-
V1025	8.4	7.3	14 mm	192	010252	14,65
V1026	8.4	7.5	15 mm	200	010269	14,95
V1027	10	7.7	16 mm	210	010276	16,95
V1028	10	7.9	17 mm	225	010283	16,95
V1029	11.5	8.4	18 mm	235	010290	18,15
V1030	11.5	8.7	19 mm	245	010306	19,05
V4961	12.5	9	21 mm	275	049610	27,75
V4962	13.5	10	22 mm	285	049627	30,70
V4963	13.5	11	24 mm	296	049634	34,65
V4964	13.5	12	27 mm	340	049641	47,45
V4965	16	13	30 mm	369	049658	70,60
V4966	16	14	32 mm	395	049665	80,-

## V1031, EAN 4047728010313

### Ratschen-Ring-Maulschlüssel Satz · lang

- Rolltasche
- Oberfläche: verchromt, poliert
- 72 Zähne
- 5° Betätigungswinkel



**163,50 €**  
zzgl. MwSt.

XX	Ausführung	SW
12 x		8 · 9 · 10 · 11 · 12 · 13 · 14 · 15 · 16 · 17 · 18 · 19 mm

## V2820, EAN 4047728028202

### Ratschen-Ring-Maulschlüssel Satz · lang

- Rolltasche
- Oberfläche: verchromt, poliert
- 72 Zähne
- 5° Betätigungswinkel



**73,45 €**  
zzgl. MwSt.

XX	Ausführung	SW
5 x		8 · 10 · 13 · 17 · 19 mm



## Doppelgelenk Ratschen-Ring-Maulschlüssel

- Ratschenkopf mit Doppelgelenk
- Doppelsechskant Profil im Ring
- 72 Zähne
- 5° Betätigungswinkel

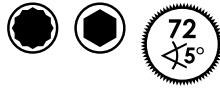

VIGOR No.	a1 mm	a2 mm	SW	L mm	EAN 4047728+	€
V6752-8	7.4	4.7	8 mm	163	067522	26,75
V6752-9	7.4	5.3	9 mm	168	067836	26,75
V6752-10	8.4	5.7	10 mm	178	067843	27,25
V6752-11	8.4	6.1	11 mm	186	067850	27,75
V6752-12	8.4	6.4	12 mm	196	067867	29,20
V6752-13	8.4	6.6	13 mm	206	067874	29,60
V6752-14	8.4	7.3	14 mm	217	067881	32,20
V6752-15	8.4	7.5	15 mm	228	067898	33,65
V6752-16	10	7.7	16 mm	245	067904	35,65
V6752-17	10	7.9	17 mm	259	068017	37,65
V6752-18	11.5	8.4	18 mm	273	068024	41,10
V6752-19	11.5	8.7	19 mm	285	068031	42,60

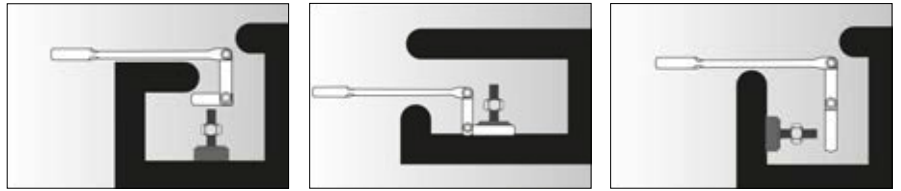
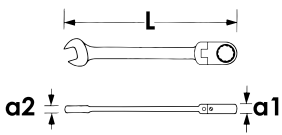

V6752/12, EAN 4047728068048

## Doppelgelenk Ratschen-Ring-Maulschlüssel Satz

- Ratschenkopf mit Doppelgelenk
- Doppelsechskant Profil im Ring
- In Rolltasche
- 72 Zähne
- 5° Betätigungswinkel



**396,- €**  
zzgl. MwSt.

XX	Ausführung	SW
12 x		8 · 9 · 10 · 11 · 12 · 13 · 14 · 15 · 16 · 17 · 18 · 19 mm

V6752/5, EAN 4047728072113

## Doppelgelenk Ratschen-Ring-Maulschlüssel Satz

- Ratschenkopf mit Doppelgelenk
- Doppelsechskant Profil im Ring
- 72 Zähne
- 5° Betätigungswinkel



**132,- €**  
zzgl. MwSt.

XX	Ausführung	SW
5 x		8 · 10 · 13 · 17 · 19 mm



## Gelenk Ratschen-Ring-Maulschlüssel

- 72 Zähne
- 5° Betätigungswinkel

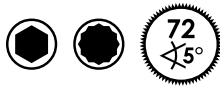

VIGOR No.	a1 mm	a2 mm	SW	L mm	EAN 4047728+	€
V2804	7.4	5	8 mm	143	028042	14,25
V2805	7.4	5.3	9 mm	150	028059	14,75
V2806	8.4	5.9	10 mm	158	028066	15,15
V2807	8.4	6.1	11 mm	165	028073	15,45
V2808	8.4	6.4	12 mm	170	028080	16,05
V2809	8.4	6.7	13 mm	182	028097	18,70
V2810	8.4	7.4	14 mm	190	028103	18,85
V2811	8.5	7.6	15 mm	200	028110	19,50
V2812	9.9	7.6	16 mm	215	028127	20,60
V2813	10	8	17 mm	228	028134	22,60
V2814	11.1	8.2	18 mm	241	028141	22,80
V2817	11.5	8.7	19 mm	250	028172	23,50

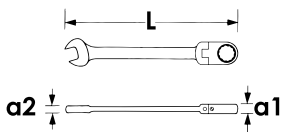

## V2818, EAN 4047728028189

### Gelenk Ratschen-Ring-Maulschlüssel Satz

- Rolltasche
- Oberfläche: verchromt, poliert
- 72 Zähne
- 5° Betätigungswinkel



**203,- €**  
zzgl. MwSt.

xx	Ausführung	SW
12 x		8 · 9 · 10 · 11 · 12 · 13 · 14 · 15 · 16 · 17 · 18 · 19 mm



**V3607**, EAN 4047728**036078**

**Doppel Ratschen-Ringschlüssel**

- 72 Zähne
- 5° Betätigungswinkel



Multiprofil



10



13

10 mm

4 in 1

13 mm



8 mm

12 mm

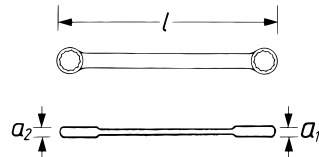

VIGOR No.	a1 mm	a2 mm	SW	l mm	EAN 4047728+	€
<b>V3607</b>	12.5	14.5	8x12 · 10x13	220	036078	24,35



**V2705**, EAN 4047728**027052**

**Doppel Ratschen-Ringschlüssel**

- 72 Zähne
- 5° Betätigungswinkel



Doppel-Sechskant



10



13

17 mm

4 in 1

19 mm



10 mm

13 mm

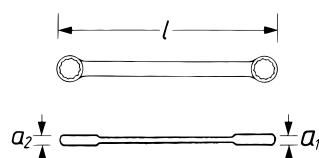

VIGOR No.	a1 mm	a2 mm	SW	l mm	EAN 4047728+	€
<b>V2705</b>	20	17	10x13 · 17x19	220	027052	33,-

V6611/4, EAN 4047728073561

## Doppel Ratschen-Ringschlüssel Satz

- Rolltasche
- Oberfläche: hochglanzverchromt
- 72 Zähne
- 5° Betätigungswinkel



**85,50 €**  
zzgl. MwSt.

XX		Ausführung	SW
1 x			E6, E8
1 x			E10, E12
1 x			E14, E18
1 x			E20, E24

## Rollgabelschlüssel

- Einhandverstellung der Schlüsselweite durch Verstellrad am Schlüsselkopf
- Maulstellung 15° abgewinkelt
- Gut lesbare mm-Skala am Schlüsselkopf



mm-Skala am Schlüsselkopf



Aufhängeloch



VIGOR No.	L mm	sb mm	EAN 4047728+	€
V6048	150	24	069625	18,70
V6049	250	33	069618	30,85



**V1208**, EAN 4047728012089

Schraubendreher · kurz

• 5,5x38 mm



**5,65 €**  
zzgl. MwSt.

**V1209**, EAN 4047728012096

Schraubendreher · kurz

• PH 2x38 mm



**5,65 €**  
zzgl. MwSt.

## Schlitz-Schraubendreher

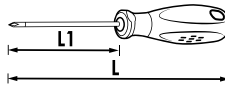

VIGOR No.	SW	L1 mm	mm	EAN 4047728+	€
V1698	0.6x3 mm	75	156	016988	3,75
V1699	0.8x4 mm	80	161	016995	3,75
V1700	1x5.5 mm	125	231	017008	4,70
V1701	1.2x6.5 mm	150	256	017015	4,95
V3613	1.6x8 mm	150	266	036139	5,90
V3609	1.6x10 mm	175	291	036092	6,-

## Kreuzschlitz-Schraubendreher

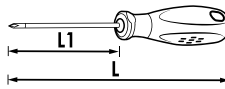

VIGOR No.	SW	L1 mm	mm	EAN 4047728+	€
V1702	PH0	75	156	017022	3,75
V1703	PH1	80	186	017039	3,75
V1704	PH2	100	206	017046	4,95
V3610	PH3	150	266	036108	6,-

## Schlitz-Schraubendreher mit Schlagkappe

• Nach DIN/ISO gefertigt

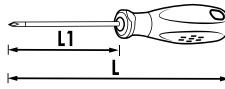

VIGOR No.	SW	L1 mm	mm	EAN 4047728+	€
V3597	0.6x3.5 mm	75	157	035972	5,75
V3598	1x4.5 mm	100	182	035989	5,75
V3599	1x5.5 mm	100	207	035996	6,40
V3600	1.2x6.5 mm	125	232	036009	7,45
V5042	1.6x8 mm	150	267	050425	8,40
V5043	1.6x10 mm	175	297	050432	9,85
V5044	2x12 mm	200	317	050449	11,20

## Kreuzschlitz-Schraubendreher mit Schlagkappe

• Nach DIN/ISO gefertigt

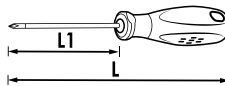

VIGOR No.	SW	L1 mm	mm	EAN 4047728+	€
V3601	PH1	182	75	036016	5,75
V3602	PH2	207	100	036023	6,40
V4667	PH3	200	315	046671	10,35

# Schraubendreher und Bits



**V4655**, EAN 4047728**046558**

**Schraubendreher Satz**

• Nach DIN/ISO gefertigt



XX		Ausführung	SW
1 x	⊖		1x5.5 mm
5 x	⊖		0.6x3 · 0.8x4 · 1x5.5 · 1.6x8 · 1.6x10 mm
1 x	⊕		PH2
4 x	⊕		PH0 · PH1 · PH2 · PH3

**51,70 €**  
zzgl. MwSt.

**V1637**, EAN 4047728**016377**

**Schraubendreher Satz**

• Nach DIN/ISO gefertigt



XX		Ausführung	SW
4 x	⊖		0.6x3 · 0.8x4 · 1x5.5 · 1.2x6.5 mm
3 x	⊕		PH0 · PH1 · PH2

**25,35 €**  
zzgl. MwSt.

**V3562**, EAN 4047728**035620**

**Schraubendreher Satz mit Schlagkappe**

• Nach DIN/ISO gefertigt



Mit Schlagkappe

6-kant



XX		Ausführung	SW
4 x	⊖		0.6x3.5 · 1x4.5 · 1x5.5 · 1.2x6.5 mm
2 x	⊕		PH1 · PH2

**36,85 €**  
zzgl. MwSt.



**V4432/6**, EAN 4047728073868

## Schraubendreher Satz · extra lang

• Arbeiten an schwer zugänglichen Stellen

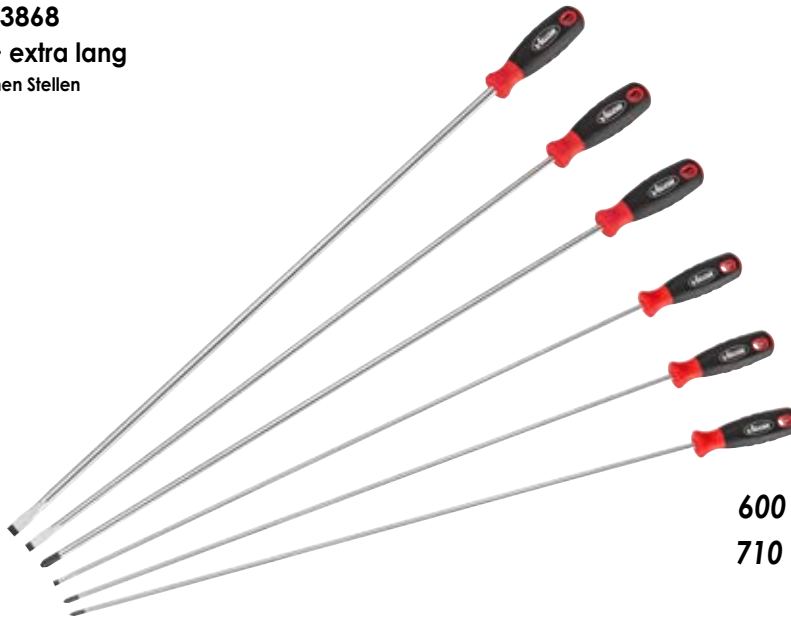

600 mm Klingenlänge  
710 mm Gesamtlänge

VIGOR No.	Bezeichnung	Ausführung		SW	mm	EAN 4047728+	€
V4436	Schlitz-Schraubendreher · extra lang		⊖	1.2x6 mm	600	073905	12,70
V4437	Schlitz-Schraubendreher · extra lang		⊖	1.6x8 mm	600	073912	14,25
V4438	Schlitz-Schraubendreher · extra lang		⊖	1.6x10 mm	600	073929	15,85
V4433	Kreuzschlitz-Schraubendreher · extra lang		⊕	PH1	600	073875	11,90
V4434	Kreuzschlitz-Schraubendreher · extra lang		⊕	PH2	600	073882	12,70
V4435	Kreuzschlitz-Schraubendreher · extra lang		⊕	PH3	600	073899	13,50

**78,90 €**  
zzgl. MwSt.

**V7124**, EAN 4047728071246

## Schlag-Schraubendreher Satz

- Betätigen von stark korrodierten Verschraubungen, z.B. Zentrierschrauben bei Bremsscheiben
- Durch Hammerschlag wird am Schraubendreher-Abtrieb eine Vierteldrehung in Löserichtung getätigt
- Umstellen der Modi durch Drehen des Einstellrads in 2 Schritten: Standard-Modus und Schlagfunktion



VIGOR No.	Bezeichnung	Ausführung		SW	mm	EAN 4047728+	€
V7124-PH1	Schlag-Schraubendreher		⊕	PH1	160	071253	16,20
V7124-PH2	Schlag-Schraubendreher		⊕	PH2	185	071260	16,20
V7124-PH3	Schlag-Schraubendreher		⊕	PH3	210	071277	16,20
V7124-PZ1	Schlag-Schraubendreher		⊕	PZ1	185	071284	16,20
V7124-PZ2	Schlag-Schraubendreher		⊕	PZ2	185	071291	16,20
V7124-T20	Schlag-Schraubendreher		⊕	T20	160	071307	16,20
V7124-T25	Schlag-Schraubendreher		⊕	T25	185	071413	16,20
V7124-T30	Schlag-Schraubendreher		⊕	T30	210	071420	16,20

**82,75 €**  
zzgl. MwSt.

# Schraubendreher und Bits



## T Schraubendreher

• Nach DIN/ISO gefertigt

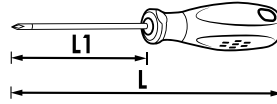

VIGOR No.	SW	L1 mm	mm	EAN 4047728+	€
V4419	T6	74	154	044196	4,10
V4420	T7	74	154	044202	4,10
V4421	T8	74	154	044219	4,10
V4422	T9	74	154	044226	4,10
V3367	T10	100	206	033671	4,80
V3368	T15	100	206	033688	5,30
V3369	T20	100	206	033695	5,30
V3370	T25	100	206	033701	5,65
V3391	T27	100	206	033916	6,15
V3392	T30	100	206	033923	6,15
V3393	T40	100	206	033930	7,-

## V4418, EAN 4047728044189

### T Schraubendreher Satz

• Nach DIN/ISO gefertigt



**14,20 €**  
zzgl. MwSt.

XX	Ausführung	SW
4 x		T6 · T7 · T8 · T9

## V3366, EAN 4047728033664

### T Schraubendreher Satz

• Nach DIN/ISO gefertigt



**32,40 €**  
zzgl. MwSt.

XX	Ausführung	SW
7 x		T10 · T15 · T20 · T25 · T27 · T30 · T40



## Schraubendreher · flexibel

- Schlauchschellen an Kühlmittelschläuchen
- Arbeiten auch in engen Bereichen, die mit einem herkömmlichen Schraubendreher nicht erreichbar wären
- Ausführung mit doppelter Spiralfeder inklusive Kunststoff-Ummantelung

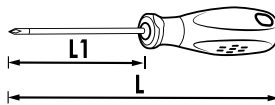

VIGOR No.	SW	L mm	EAN 4047728+	€
V4664	6 mm	300	046640	10,60
V4665	7 mm	300	046657	10,60
V4666	8 mm	300	046664	10,60

## V5661, EAN 4047728056618

### Schraubendreher Satz · flexibel

- Schlauchschellen an Kühlmittelschläuchen
- Arbeiten auch in engen Bereichen, die mit einem herkömmlichen Schraubendreher nicht erreichbar wären
- Ausführung mit doppelter Spiralfeder inklusive Kunststoff-Ummantelung



**30,85 €**  
zzgl. MwSt.

XX	Ausführung	SW
3 x		6 · 7 · 8 mm

## V5485N, EAN 4047728060714

### Schraubendreher Satz · extra lang · flexibel

- Arbeiten an schwer zugänglichen Stellen
- Extraplang, Länge: 500 mm
- Universelle 6,3 mm (1/4") Bit-Aufnahme
- Universeller 6,3 mm (1/4") Vierkant
- 7 mm Sechskant Abtrieb



**57,85 €**  
zzgl. MwSt.



XX	Bit	Bit	Ausführung	SW
6 x	6.3 1/4"			T10 · T15 · T20 · T25 · T27 · T30
2 x	6.3 1/4"			PH1 · PH2
2 x	6.3 1/4"			1 x 5.5 · 1.2 x 6.5 mm
1 x	-	6.3 1/4"		500 mm
1 x	-	6.3 1/4"		500 mm
1 x	-			7 mm
5 x	6.3 1/4"			5 · 6 · 7 · 8 · 10 mm



# Schraubendreher und Bits



**V5601**, EAN 4047728056014

## Winkelschraubendreher Satz

- Im Clip
- Lange Ausführung
- Kugelkopf
- Inhalt: 1,5 · 2 · 2,5 · 3 · 4 · 5 · 6 · 7 · 8 · 10 mm



Inklusive SW 7 mm



**22,30 €**  
zzgl. MwSt.

**V4942**, EAN 4047728049429

## Winkelschraubendreher Satz

- Im Clip
- Lange Ausführung
- Kugelkopf
- Inhalt: 1,5 · 2 · 2,5 · 3 · 4 · 5 · 6 · 8 · 10 mm



**18,50 €**  
zzgl. MwSt.

**V4708**, EAN 4047728047081

## T Winkelschraubendreher Satz

- Im Clip
- Lange Ausführung
- Kugelkopf
- Inhalt: T10 · T15 · T20 · T25 · T27 · T30 · T40 · T45 · T50



**31,10 €**  
zzgl. MwSt.



**V4303**, EAN 4047728**043038**

## Elektronik-Schraubendreher Satz

- Drehbares Kopfteil und Schnelldreh-Zone
- Vier Schraubendreher für Schlitzschrauben 1,6 · 2 · 2,4 · 3 mm
- Zwei Schraubendreher für Kreuzschlitzschrauben PH00 · PH0
- In Kunststoff-Box



**25,35 €**  
zzgl. MwSt.

XX	Ausführung	SW
4 x		1,6 · 2 · 2,4 · 3
2 x		PH0 · PH00

**V3427N**, EAN 4047728**058865**

## Bit Schraubendreher

- Für Handbetätigung



6.3 1/4"

**12,60 €**  
zzgl. MwSt.

## Sechskant Steckschlüssel-Schraubendreher

- Oberfläche: verchromt



VIGOR No.	SW	L1 mm	EAN 4047728+	€
V4200	6 mm	150	042000	9,55
V4221	7 mm	150	042215	9,55
V4222	8 mm	150	042222	9,95
V4223	10 mm	150	042239	10,55
V4224	12 mm	150	042246	10,90
V4225	13 mm	150	042253	11,25

**V4199**, EAN 4047728**041997**

## Sechskant Steckschlüssel-Schraubendreher Satz

- Oberfläche: verchromt



**57,50 €**  
zzgl. MwSt.

XX	Ausführung	SW
6 x		6 · 7 · 8 · 10 · 12 · 13 mm

# Schraubendreher und Bits



## Sechskant T-Griff Schraubendreher



VIGOR No.	SW	L1 mm	L mm	EAN 4047728+	€
V2489	2 mm	100	160	024891	4,95
V2486	2.5 mm	100	160	024860	4,95
V2507	3 mm	100	160	025072	4,95
V2506	4 mm	100	160	025065	5,65
V2505	5 mm	100	160	025058	5,65
V2504	6 mm	132	217	025041	5,75
V2503	8 mm	132	217	025034	6,85
V2502	10 mm	132	217	025027	7,-

## V1409, EAN 4047728014090

### Sechskant T-Griff Schraubendreher Satz

• Inklusive Halter



Inklusive



**38,15 €**  
zzgl. MwSt.

XX	Ausführung	SW
8 x		2 · 2.5 · 3 · 4 · 5 · 6 · 8 · 10 mm

## T-Griff Schraubendreher



VIGOR No.	SW	L1 mm	L mm	EAN 4047728+	€
V2498	T9	100	160	024983	5,75
V2497	T10	100	160	024976	5,75
V2501	T15	100	160	025010	5,75
V2490	T20	100	160	024907	5,75
V2485	T25	100	160	024853	5,75
V2484	T27	132	217	024846	5,90
V2483	T30	132	217	024839	6,15
V2482	T40	132	217	024822	7,10

## V1410, EAN 4047728014106

### T-Griff Schraubendreher Satz



Inklusive



**44,25 €**  
zzgl. MwSt.

XX	Ausführung	SW
8 x		T9 · T10 · T15 · T20 · T25 · T27 · T30 · T40



**V7601-150**, EAN 4047728**079433**

## Bithalter mit Magnetring · lang

- Starker Magnetring zur Sicherung von Schrauben
- Bit kann im Halter versenkt werden, um Auflagefläche für Schraubenkopf zu schaffen
- Ideal für schwer erreichbare Stellen

6.3 1/4" 6.3 1/4"

**NEU**

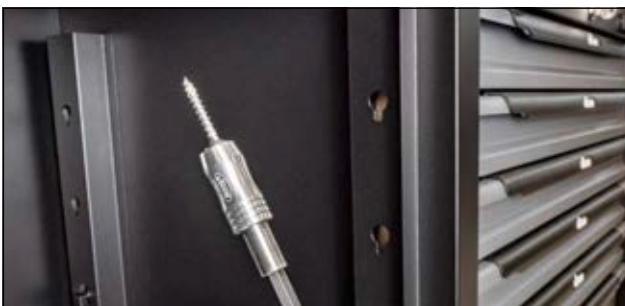

VIGOR No.	d1 mm	L mm	EAN 4047728+	€
V7601-150	15.5	150	079433	13,20
V7601-250	15.5	250	079426	14,60



**V7600**, EAN 4047728**079440**

## Bithalter mit Gelenk

- 20° Schwenkwinkel
- Bithalter lässt sich arretieren
- Für Maschinenbetätigung



6.3 1/4" 6.3 1/4"

**NEU**

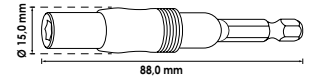

**15,30 €**  
zzgl. MwSt.

## Steckschlüssel Adaptersatz

6.3 1/4" 10 3/8" 12.5 1/2" 6.3 1/4"

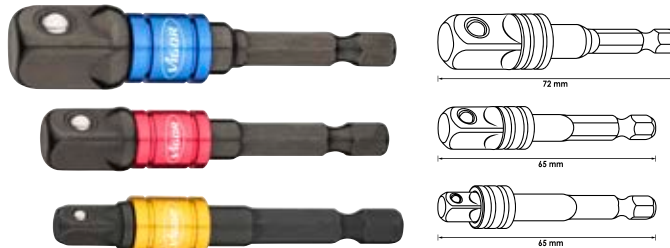

**NEU**

VIGOR No.	EAN	€
V7603/3	4047728+ 079471	13,20

## Steckschlüssel Adapter · mit Gelenk

- 20° Schwenkwinkel
- Steckschlüssel Adapter lässt sich arretieren
- Für Maschinenbetätigung



6.3 1/4" 6.3 1/4"

**NEU**

VIGOR No.	mm	EAN	€
V7614	90	4047728+ 079457	11,50

## Steckschlüssel Adapter · mit Gelenk

- 20° Schwenkwinkel
- Steckschlüssel Adapter lässt sich arretieren
- Für Maschinenbetätigung



10 3/8" 6.3 1/4"

**NEU**

VIGOR No.	mm	EAN	€
V7638	92	4047728+ 079464	16,-



**V5019**, EAN 4047728**050197**

**Bit Box**

• ~ DIN / ISO



XX	■	■	Ausführung	SW
7 x			T10 · T15 · T20 · T25 · T27 · T30 · T40	
4 x			3 · 4 · 5 · 6 mm	
3 x			PH1 · PH2 · PH3	
3 x			PZ1 · PZ2 · PZ3	
4 x			0.5x3 · 0.8x4 · 1x5 · 1x6 mm	
7 x			T10H · T15H · T20H · T25H · T27H · T30H · T40H	
1 x			60 mm	
1 x			25 mm	

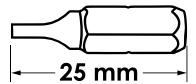

**22,80 €**  
zzgl. MwSt.



**V5502**, EAN 4047728**055024**

**Bit Box**

• Schraubarbeiten in Werkstatt, Industrie, Handwerk, Heim und Hobby  
• ~ DIN / ISO



XX	■	■	Ausführung	SW
7 x			T10 · T15 · T20 · T25 · T27 · T30 · T40	
4 x			3 · 4 · 5 · 6 mm	
3 x			PH1 · PH2 · PH3	
3 x			PZ1 · PZ2 · PZ3	
4 x			0.5x3 · 0.8x4 · 1x5 · 1x6 mm	
7 x			T10H · T15H · T20H · T25H · T27H · T30H · T40H	
1 x	-		95 mm	
1 x			60 mm	

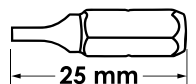

**37,20 €**  
zzgl. MwSt.

# Schraubendreher und Bits



**V5020**, EAN 4047728050203

Bit Box

• ~ DIN / ISO



			Ausführung	SW
7 x				T10 · T15 · T20 · T25 · T27 · T30 · T40
2 x				T20 · T25
3 x				3 · 4 · 5 mm
3 x				PH1 · PH2 · PH3
2 x				PH1 · PH2
3 x				PZ1 · PZ2 · PZ3
2 x				PZ1 · PZ2
3 x				0.5 x 3 · 0.8 x 4 · 1 x 5 mm
1 x				1 x 6 mm
7 x				T10H · T15H · T20H · T25H · T27H · T30H · T40H
1 x				60 mm
1 x				25 mm

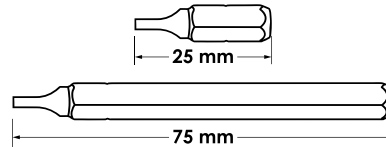

**43,20 €**  
zzgl. MwSt.

**V6068**, EAN 4047728060684

Bit Box

• ~ DIN / ISO



Inklusive Display bei einer Abnahme von mindestens 10 Stück



			Ausführung	SW
7 x				T10 · T15 · T20 · T25 · T27 · T30 · T40
4 x				3 · 4 · 5 · 6 mm
3 x				PH1 · PH2 · PH3
3 x				PZ1 · PZ2 · PZ3
4 x				0.5 x 3 · 0.8 x 4 · 1 x 5 · 1.2 x 6.5 mm

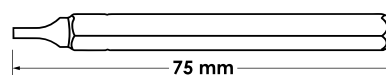

**41,50 €**  
zzgl. MwSt.



**V7784**, EAN 4047728**077842**

## Ratschenschlüssel Bit Satz

- Gute Erreichbarkeit von schwer zugänglichen Stellen: Bits werden in die Ratsche eingesteckt → Ratschenkopfhöhe sehr gering
- Bit Sortiment mit 10 mm Sechskant Aufnahme
- 2 Aufnahmen:  
Starre Seite zum Lösen von festsitzenden Verschraubungen  
Bit Ratschen-Aufnahme mit Feinverzahnung von 72 Zähnen
- Länge Ratschen Schlüssel: 250 mm

10 <sup>3/8</sup>"



**98,05 €**  
zzgl. MwSt.

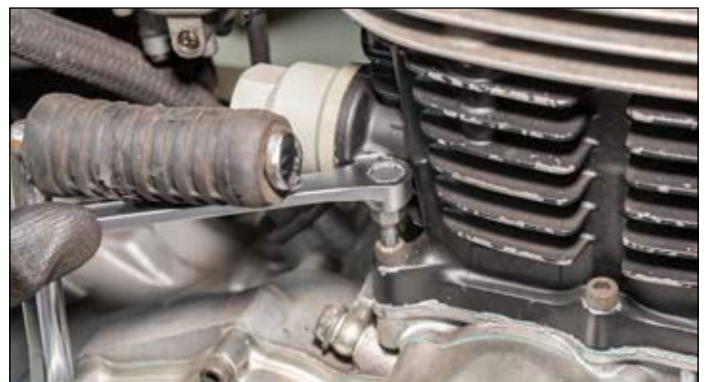

XX	■		Ausführung	SW
10 x	10 <sup>3/8</sup> "	⊕		T10 · T15 · T20 · T25 · T27 · T30 · T40 · T45 · T50 · T55
10 x	10 <sup>3/8</sup> "	⊕		T10H · T15H · T20H · T25H · T27H · T30H · T40H · T45H · T50H · T55H
6 x	10 <sup>3/8</sup> "	○		4 · 5 · 6 · 7 · 8 · 10 mm
6 x	10 <sup>3/8</sup> "	○		M4 · M5 · M6 · M8 · M10 · M12
6 x	10 <sup>3/8</sup> "	⊕		M5 · M6 · M7 · M8 · M9 · M10





# Zangen



**V5650**, EAN 4047728056502

## Seitenschneider mit Doppelgelenk

- Extrem schmale Ausführung
- Für schwer zugängliche Bereiche

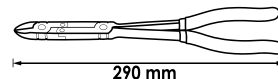

**43,20 €**  
zzgl. MwSt.



**V2781**, EAN 4047728027816

## Kombizange mit Doppelgelenk

- Gezähnte, extrem schmale Ausführung
- Für schwer zugängliche Bereiche

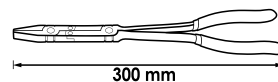

**43,20 €**  
zzgl. MwSt.



**V2782**, EAN 4047728027823

## Flachrund-Zange mit Doppelgelenk

- Gezähnte, extrem schmale Ausführung
- Für schwer zugängliche Bereiche



**43,20 €**  
zzgl. MwSt.



**V2783**, EAN 4047728027830

## Flachrund-Zange mit Doppelgelenk

- Gezähnte, extrem schmale Ausführung
- Für schwer zugängliche Bereiche

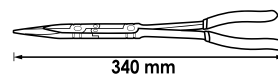

**43,20 €**  
zzgl. MwSt.



**V5493**, EAN 4047728054935

## Zündkerzenzange mit Doppelgelenk

- Aufstecken und Abziehen von schwer erreichbaren Zündkerzensteckern
- Auch zum Trennen von Kraftstoffleitung-Verbindungen
- 45° abgewinkelter Kopf

*Sichere Handhabung durch eingearbeitete Verzahnung*

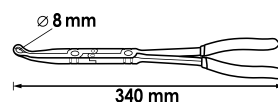

**43,30 €**  
zzgl. MwSt.



**V5494**, EAN 4047728054942

## Zündkerzenzange mit Doppelgelenk

- Aufstecken und Abziehen von schwer erreichbaren Zündkerzensteckern
- Auch zum Trennen von Kraftstoffleitung-Verbindungen
- 45° abgewinkelter Kopf

*Sichere Handhabung durch eingearbeitete Verzahnung*

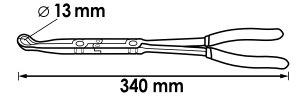

**43,20 €**  
zzgl. MwSt.

**V5496**, EAN 4047728054966

## Sicherungsring-Zange mit Doppelgelenk · Innensicherung

- Innensicherungen (Bohrungen) 8 – 30 mm Ø
- Besonders einfacher Wechsel der Spitzen
- Spitzen farblich codiert
- Ausführung Spitzen / Inhalt:
  - 2x Ø 1,0 mm gerade
  - 2x Ø 1,0 mm 90° abgewinkelt
  - 2x Ø 1,3 mm gerade
  - 2x Ø 1,3 mm 90° abgewinkelt
  - 2x Ø 1,8 mm gerade
  - 1 x Innensechskant-Schlüssel

*Doppelgelenk überträgt bereits kleinste Griffbewegungen exponentiell verstärkt an die Spitzen*

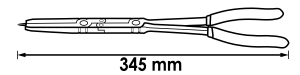

**65,50 €**  
zzgl. MwSt.

**V5496-1**, EAN 4047728054980

## Ersatzspitzen Satz für Sicherungsring-Zange mit Doppelgelenk

- Sicherungsringzangen mit Doppelgelenk V5496 · V5497
- Inhalt:
  - 2x Ø 1,0 mm · gerade
  - 2x Ø 1,0 mm · 90° abgewinkelt
  - 2x Ø 1,3 mm · gerade
  - 2x Ø 1,3 mm · 90° abgewinkelt
  - 2x Ø 1,8 mm · gerade
  - 1 x Innensechskant-Schlüssel



**19,80 €**  
zzgl. MwSt.

**V5497**, EAN 4047728054973

## Sicherungsring-Zange mit Doppelgelenk · Außensicherung

- Außensicherungen (Wellen) 12 – 30 mm Ø
- Besonders einfacher Wechsel der Spitzen
- Spitzen farblich codiert
- Ausführung Spitzen / Inhalt:
  - 2x Ø 1,0 mm gerade
  - 2x Ø 1,0 mm 90° abgewinkelt
  - 2x Ø 1,3 mm gerade
  - 2x Ø 1,3 mm 90° abgewinkelt
  - 2x Ø 1,8 mm gerade
  - 1 x Innensechskant-Schlüssel

*Doppelgelenk überträgt bereits kleinste Griffbewegungen exponentiell verstärkt an die Spitzen*

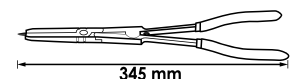

**65,50 €**  
zzgl. MwSt.



# Zangen



**V6510-10/4**, EAN 4047728076951

Sicherungsring-Zangen Satz · 140 mm



**107,- €**  
zzgl. MwSt.



XX	Ausführung	SW
1 x		140 mm
1 x		140 mm
1 x		140 mm
1 x		140 mm

**V6510-19/4**, EAN 4047728076968

Sicherungsring-Zangen Satz · 180 mm



**114,50 €**  
zzgl. MwSt.



XX	Ausführung	SW
1 x		180 mm
1 x		180 mm
1 x		180 mm
1 x		180 mm

## Sicherungsring-Zange

- Für Außensicherungen
- Form A
- Gerade Ausführung

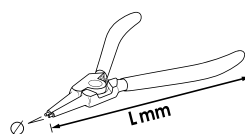

VIGOR No.	● mm	≡ mm	← L → mm	EAN 4047728+	€
<b>V6510A-10</b>	10-25 mm	1.3	140	076807	29,50
<b>V6510A-19</b>	19-60 mm	1.8	180	076814	32,45
<b>V6510A-40</b>	40-100 mm	2.3	230	076821	42,70

## Sicherungsring-Zange

- Für Außensicherungen
- Form B
- Abgewinkelt

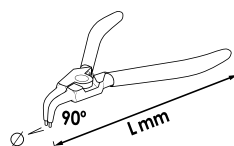

VIGOR No.	● mm	≡ mm	← L → mm	EAN 4047728+	€
<b>V6510B-10</b>	10-25 mm	1.3	140	076838	29,50
<b>V6510B-19</b>	19-60 mm	1.8	180	076845	32,45
<b>V6510B-40</b>	40-100 mm	2.3	230	076852	42,70



## Sicherungsring-Zange

- Für Innensicherungen
- Form C
- Gerade Ausführung

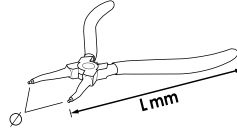

VIGOR No.	mm	mm	L mm	EAN 4047728+	€
V6510C-12	12-25 mm	1.3	140	076869	29,50
V6510C-19	19-60 mm	1.8	180	076876	32,45
V6510C-40	40-100 mm	2.3	230	076883	42,70

## Sicherungsring-Zange

- Für Innensicherungen
- Form D
- Abgewinkelt

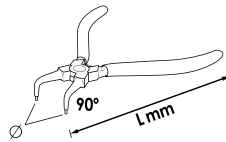

VIGOR No.	mm	mm	L mm	EAN 4047728+	€
V6510D-12	12-25 mm	1.3	140	077248	29,50
V6510D-19	19-60 mm	1.8	180	076906	32,45
V6510D-40	40-100 mm	2.3	230	076913	42,70

## Maul-Gripzange

- Sicheres Greifen von Müttern oder Schraubenköpfen
- Größenverstellung durch Justierschraube
- Feststell-Arretierung am Griff
- Verzahnte Maulinnenfläche
- Ergonomisch geformt, einfache Handhabung
- Chrom-Molybdän
- Vernickelt

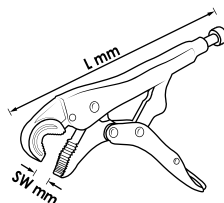

Drahtschneider



VIGOR No.	SW	L mm	EAN 4047728+	€
V3738-S	6 - 13 mm	100	069540	21,60
V3738	11 - 19 mm	175	037389	26,15
V3739	16 - 27 mm	250	037396	30,85

**V1808**, EAN 4047728018081

## Gripzangen Satz

- Größenverstellung durch Justierschraube
- Feststell-Arretierung am Griff
- Verzahnte Maulinnenfläche
- Ergonomisch geformt, einfache Handhabung
- Chrom-Molybdän
- Vernickelt



Lieferung in praktischer Rolltasche



VIGOR No.	Bezeichnung	Ausführung	mm	EAN 4047728+	€
V1802	Maul-Gripzange		150	018029	20,40
V1803	Maul-Gripzange		250	018036	24,25
V1804	Maul-Gripzange		125	018043	21,60

**66,20 €**  
zzgl. MwSt.

**V4640**, EAN 4047728081726

## Schlauchschellen-Zange

- Befähigung von Schlauch- und Federbandschellen
- Drehbare Backen für beengte Platzverhältnisse
- Arretierung zum vorübergehenden Halten der Schelle

**NEU**



**79,- €**  
zzgl. MwSt.



**V4637N**, EAN 4047728**075565**

## Schlauch- und Federbandschellen-Zange

- Betätigung von schwer erreichbaren, selbstspannenden Schlauch- und Federbandschellen
- Bowdenzug-Arretierung zum vorübergehenden Halten der Schelle
- Einfaches Lösen der Arretierung durch innenliegende Feder
- Ermüdungsfreies Arbeiten durch innenliegende Feder im Handgriff
- Gesamtlänge Bowdenzug: 590 mm
- Spannungsbereich: 18–53 mm



**93,35 €**  
zzgl. MwSt.

**V4737**, EAN 4047728**075572**

## Kraftstoffleitungs-Zange

- Betätigen von schwer erreichbaren Kraftstoffleitungs-Kupplungen
- Flexibler Bowdenzug
- Kein Beschädigen der Kupplungen und Schläuche durch fachgerechtes Betätigen der Schnellverschlüsse
- Bowdenzug-Arretierung ermöglicht präzises Einstellen der Spanne
- Einfaches Lösen der Arretierung durch innenliegende Feder
- Gesamtlänge Bowdenzug: 590 mm
- Öffnungsweite: 30 mm



**143,- €**  
zzgl. MwSt.

**V4641**, EAN 4047728**075558**

## Spannschellen-Zange

- Betätigung von stufen- und ohrlosen Spannschellen an Achsmanschetten (auch Thermoplast-Achsmanschetten)
- Präzises Anziehen durch gleichmäßiges Zusammendrücken



**71,10 €**  
zzgl. MwSt.

**V4196**, EAN 4047728**041966**  
Zange für Kunststoffnieten



Inklusive 40 Kunststoffnieten

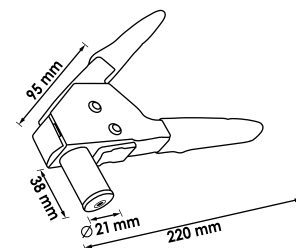

**91,65 €**  
zzgl. MwSt.

**V6799**, EAN 4047728**067997**  
Abklemmzangen Satz

- Abklemmen von flexiblen Schlauchleitungen
- Sichere, verstellbare Arretierung
- Wartungsarbeiten mit Benzin, Kühlerfrostschutzmittel, Öl etc.
- Temperaturbeständigkeit bis 220° C

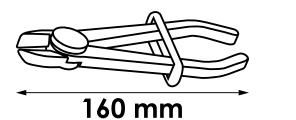
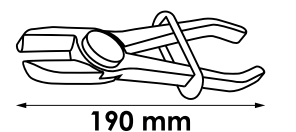
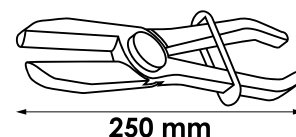

**25,35 €**  
zzgl. MwSt.

**V3735**, EAN 4047728**037358**

## Nietzange für Blindnieten und Nietmuttern · universal

- Nietmuttern: M 5 · M 6 · M 8 · M 10 für Kupfer-, Messing-, Stahl- und Edelstahlnieten
- Blindnieten: 3,2 · 4,0 · 4,8 · 6,4 mm für Kupfer-, Messing-, Stahl- und Edelstahlnieten



### Ersatzteile

VIGOR No.	Bezeichnung	EAN 4047728+	€
<b>V3735-3.2</b>	Mundstück für Blindnieten · 3,2 mm	053976	4,35
<b>V3735-4.0</b>	Mundstück für Blindnieten · 4,0 mm	053617	4,35
<b>V3735-4.8</b>	Mundstück für Blindnieten · 4,8 mm	053624	4,35
<b>V3735-6.4</b>	Mundstück für Blindnieten · 6,4 mm	053631	4,35
<b>V3735-M5</b>	Mundstück für Nietmuttern · M 5	053495	25,30
<b>V3735-M6</b>	Mundstück für Nietmuttern · M 6	053501	25,30
<b>V3735-M8</b>	Mundstück für Nietmuttern · M 8	053518	25,30
<b>V3735-M10</b>	Mundstück für Nietmuttern · M 10	053525	25,30

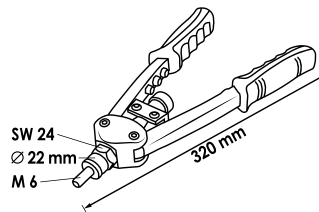

**169,50 €**  
zzgl. MwSt.

**V2788**, EAN 4047728**027885**

## Blindniet-Zange

- Für Blindnieten: 3,2 · 4,0 · 4,8 · 6,4 mm
- Für Kupfer-, Messing-, Stahl- und Edelstahlnieten
- Sehr geringer Kraftaufwand bei extrem kurzer Bauform



### Ersatzteile

VIGOR No.	Bezeichnung	EAN 4047728+	€
<b>V2788-3.2</b>	Mundstück für Blindnieten · 3,2 mm	053648	4,35
<b>V2788-4.0</b>	Mundstück für Blindnieten · 4,0 mm	053655	4,35
<b>V2788-4.8</b>	Mundstück für Blindnieten · 4,8 mm	053662	4,35
<b>V2788-6.4</b>	Mundstück für Blindnieten · 6,4 mm	053679	4,35

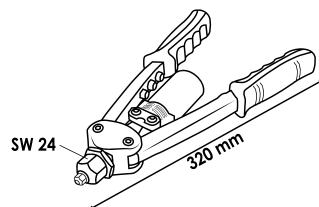

**91,65 €**  
zzgl. MwSt.





Seitenschneider



VIGOR No.	mm	EAN 4047728+	€
V6500-140	140	076753	18,15
V6500-160	160	076746	20,35



Kombizange



VIGOR No.	mm	EAN 4047728+	€
V6501-180	180	076760	20,35



Flachrund-Zange



VIGOR No.	mm	EAN 4047728+	€
V6502-200	200	076777	21,65



Flachrund-Zange · abgewinkelt



VIGOR No.	mm	EAN 4047728+	€
V6503-200	200	076791	25,75



## Rohrzange

- Robuster Zangenkörper aus Gusseisen ermöglicht hohe Kraftübertragung
- Schnelles Verkanten und Lösen am Werkstück durch innenliegende Feder
- Grobe Backenverzahnung für optimalen Halt



**NEU**

VIGOR No.	L mm	EAN 4047728+	€
V5639	350	075589	27,65
V5639-24	620	081719	46,-

## V6504-250, EAN 4047728077750

### Universalzange · mit Druckknopf

- – Wasserpumpenzange –
- Einstellung der Maulöffnung per Knopfdruck
- Einrasten des Gelenkbolzens verhindert unabsichtliches Verstellen
- Maulöffnung: bis 65 mm
- Kapazität für Muttern · sw 46 mm
- Kapazität für Rohre Ø 50 mm · Ø 2"
- Einstellpositionen: 23

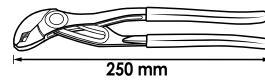

**51,50 €**  
zzgl. MwSt.

## V5681, EAN 4047728056816

### Elektronik-Seitenschneider

- Für Drahtklassen:
  - Weich bis Ø 1,6 mm
  - Mittelhart bis Ø 1,2 mm
  - Hart bis Ø 0,8 mm

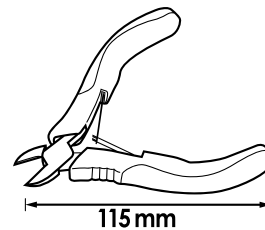

**23,65 €**  
zzgl. MwSt.



**V5632**, EAN 4047728080279

## VDE Werkzeug Satz

- Kompakter Werkzeugkoffer mit allen benötigten Werkzeugen, um ein Fahrzeug sicher stromlos zu schalten
- Zertifiziert nach DIN EN 60900 bis 1000 Volt Wechselfeldspannung bzw. 1500 Volt Gleichspannung
- Für Handbetätigung



**NEU**

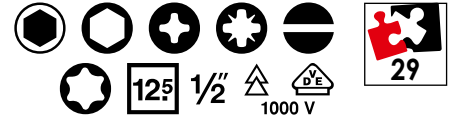

**520,- €**  
zzgl. MwSt.

XX	■		Ausführung	SW
3 x	12kV 1/2	○		5 · 8 · 6 mm
1 x	-	12kV 1/2		255 mm
9 x	12kV 1/2	●		8 · 10 · 12 · 13 · 14 · 17 · 19 · 22 · 24 mm
1 x	12kV 1/2	12kV 1/2		125 mm
1 x	-	-		200 mm
1 x	-	-		160 mm
1 x	-	-		180 mm
1 x	-	-		251 mm
4 x	-	⊕		T30 · T25 · T20 · T15
4 x	-	⊖		0.5x3 · 0.8x4 · 1x5.5 · 1.2x6.5 mm
3 x	-	⊕		PH0 · PH1 · PH2

**V3343**, EAN 4047728033435

## VDE Steckschlüssel Satz

- VDE isoliert bis 1000 V nach DIN EN 60900
- IEC 60900:2018
- Für Handbetätigung

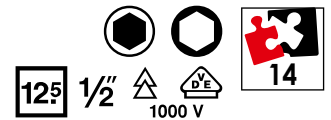

**408,- €**  
zzgl. MwSt.

XX	■		Ausführung	SW
9 x	12kV 1/2	●		8 · 10 · 12 · 13 · 14 · 17 · 19 · 22 · 24 mm
3 x	12kV 1/2	○		5 · 6 · 8 mm
1 x	12kV 1/2	12kV 1/2		125 mm
1 x	-	12kV 1/2		255 mm

## VDE Umschaltknarre

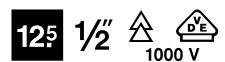

VIGOR No.	mm	EAN	€
V3342	255	4047728+033428	143,-



## VDE Verlängerung

12<sup>5</sup> 1/2" 12<sup>5</sup> 1/2" 1000 V



VIGOR No.	mm	EAN 4047728+	€
V3341	125	033411	40,75

## VDE Steckschlüsseinsatz

12<sup>5</sup> 1/2" 1000 V



VIGOR No.	SW	mm	EAN 4047728+	€
V3330	8 mm	55	033305	19,80
V3331	10 mm	55	033312	19,80
V3332	12 mm	55	033329	21,55
V3333	13 mm	55	033336	21,55
V3334	14 mm	55	033343	21,55
V3335	17 mm	55	033350	22,85
V3336	19 mm	55	033367	24,60
V3337	22 mm	55	033374	25,85
V3338	24 mm	55	033381	27,60

## VDE Schraubendreher-Einsatz

12<sup>5</sup> 1/2" 1000 V



VIGOR No.	SW	mm	EAN 4047728+	€
V3339	5 mm	78	033398	30,05
V3344	6 mm	78	033442	30,05
V3340	8 mm	78	033404	30,05

## VDE Schlitz-Schraubendreher

• Nach DIN/ISO gefertigt

1000 V

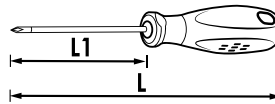

VIGOR No.	SW	L1 mm	mm	EAN 4047728+	€
V2028	0.5x3 mm	100	181	020282	4,45
V2029	0.8x4 mm	100	181	020299	5,15
V2030	1x5.5 mm	125	231	020305	6,40
V2061	1.2x6.5 mm	150	256	020619	7,80

## VDE Kreuzschlitz-Schraubendreher

• Nach DIN/ISO gefertigt

1000 V

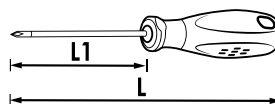

VIGOR No.	SW	L1 mm	mm	EAN 4047728+	€
V2062	PH0	60	141	020626	4,45
V2063	PH1	80	161	020633	5,70
V2064	PH2	100	206	020640	7,15

## VDE T Profil Schraubendreher

• Nach DIN/ISO gefertigt

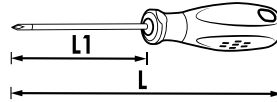

VIGOR No.	SW	L1 mm	L mm	EAN 4047728+	€
V2031-T15	T15	100	180	078122	6,50
V2031-T20	T20	100	180	078115	6,50
V2031-T25	T25	125	230	078092	6,50
V2031-T30	T30	150	250	078139	6,50

## V2027, EAN 4047728020275

### VDE Schraubendreher Satz

• Nach DIN/ISO gefertigt



**36,- €**  
zzgl. MwSt.

XX	Ausführung	SW
4 x		0.5x3 · 0.8x4 · 1x5.5 · 1.2x6.5 mm
3 x		PH0 · PH1 · PH2

## Spannungsprüfer



VIGOR No.	SW	mm	EAN 4047728+	€
V1138	0.5x3 mm	140	011389	5,95

## V5631, EAN 4047728077941

### VDE Universalzange

• VDE isoliert bis 1000 V nach DIN EN 60900  
• IEC 60900:2018



**49,- €**  
zzgl. MwSt.

**V2641**, EAN 4047728**026413**

## VDE Rundzange

• Lange Backen

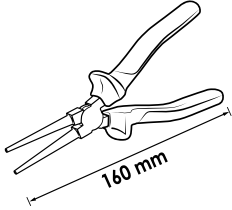

**26,20 €**  
zzgl. MwSt.

**V2628**, EAN 4047728**026284**

## VDE Kombizange

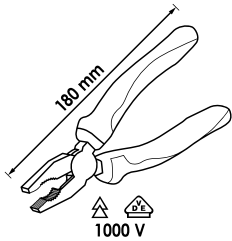

**34,90 €**  
zzgl. MwSt.

**V2629**, EAN 4047728**026291**

## VDE Seitenschneider

• Für harten Draht (H)

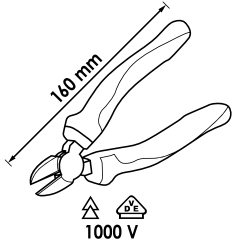

**34,90 €**  
zzgl. MwSt.

**V2630**, EAN 4047728**026307**

## VDE Flachrund-Zange

• Mit Schneide

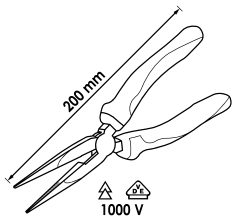

**34,90 €**  
zzgl. MwSt.

**V2643**, EAN 4047728**026437**

## VDE Abisolierzange

• Feder und Stellschraube

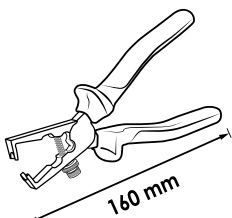

**33,- €**  
zzgl. MwSt.

## Schlosser-Hammer

- Eschestiel



VIGOR No.	— L — mm	⚖ kg	EAN 4047728+	€
V1135	300	300 g	011358	11,55
V2662	320	500 g	026628	14,75
V2665	350	800 g	026659	19,45
V2664	360	1000 g	026642	21,80
V2663	400	2000 g	026635	30,25

## Fäustel

- Eschestiel



VIGOR No.	— L — mm	⚖ kg	EAN 4047728+	€
V4235	280	1500 g	042352	26,10

## Kunststoff-Schonhammer

- Auswechselbare Köpfe aus schlagfestem Cellulose-Acetat
- Eschestiel



VIGOR No.	Durchmesser max	— L — mm	EAN 4047728+	€
V1212	32	280	012126	18,85
V4661	40	320	046619	28,25



VIGOR No.	Bezeichnung	∅ mm	EAN 4047728+	€
V3541	Ersatzkopf (Paar) für Kunststoff-Schonhammer V1212	32	035415	7,80
V4661-1	Ersatzkopf (Paar) für Kunststoff-Schonhammer V4661	40	048514	8,15



**V1221**, EAN 4047728012218

Flachmeißel

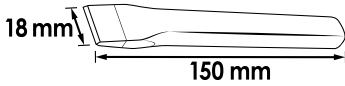

**12,- €**  
zzgl. MwSt.

**V1222**, EAN 4047728012225

Kreuzmeißel

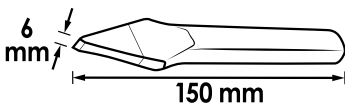

**12,- €**  
zzgl. MwSt.

**V1220**, EAN 4047728012201

Körner

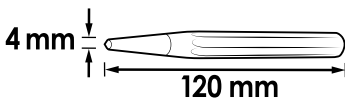

**5,80 €**  
zzgl. MwSt.

**V1783**, EAN 4047728017831

Körner · selbstschlagend

- Schlagkraft wird durch einfaches Niederdrücken des Oberteils freigesetzt

Stufenlos einstellbar

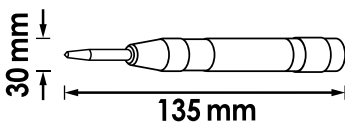

**22,95 €**  
zzgl. MwSt.

Splinttreiber



VIGOR No.	Ø	L mm	EAN 4047728+	€
V1214	2	150	012140	7,10
V1215	3	150	012157	7,10
V1216	4	150	012164	7,10
V1217	5	150	012171	7,10
V1218	6	150	012188	7,10
V1219	8	150	012195	7,65



**V1283**, EAN 4047728012836

## Schaber Satz · Edelstahl

- Entfernen von Dichtungsrückständen an Zylinderkopf-, Ventildeckel-, Vergaserdeckeldichtungen etc.
- Klängen aus Edelstahl
- Aufhängeloch
- 4-teiliger Satz

Mit Schlagkappe

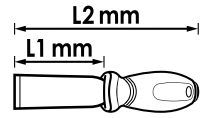

VIGOR No.	mm	mm	Meisselhöhe	EAN 4047728+	€
V2487	230	32	1.2	024877	11,20
V2488	230	32	2.5	024884	12,95
V2509	175	20	1.2	025096	11,20
V2508	175	20	2.5	025089	12,95

**46,95 €**  
zzgl. MwSt.

**V1368N**, EAN 4047728071017

## Universalschaber

- Entfernen von Vignetten, Plaketten und Aufklebern
- Auch für Ceranfeld, Windschutzscheibe etc. geeignet
- Klinge schnell und sicher auswechselbar
- Inklusive einer Klinge



**11,- €**  
zzgl. MwSt.

**V1372**, EAN 4047728013727

## Ersatzklingen



**3,15 €**  
zzgl. MwSt.

**V1213**, EAN 4047728012133

## Dichtungsschaber · lang

- Entfernung von Dichtungsrückständen an Zylinderkopf-, Ventildeckel-, Vergaserdeckeldichtungen etc.
- Lange Ausführung
- Griff aus Kunststoff



**28,10 €**  
zzgl. MwSt.

**V4663**, EAN 4047728046633

## Mini Haken Satz

- Einsetzen und Entfernen von O-Ringen oder Dichtungen
- Auch zum Entfernen der Schutzkappen bei Radbolzen
- Aufhängeloch
- Kurze Ausführung



**12,40 €**  
zzgl. MwSt.

**V5045**, EAN 4047728050456

## Haken- und Schaber Satz

- Entfernen und Einsetzen von O-Ringen und Dichtungen sowie zum Entfernen von Plaketten, Dichtungs- und Klebstoffresten
- Auch zum Entfernen von Schutzkappen bei Radbolzen
- Mit Aufhängeloch

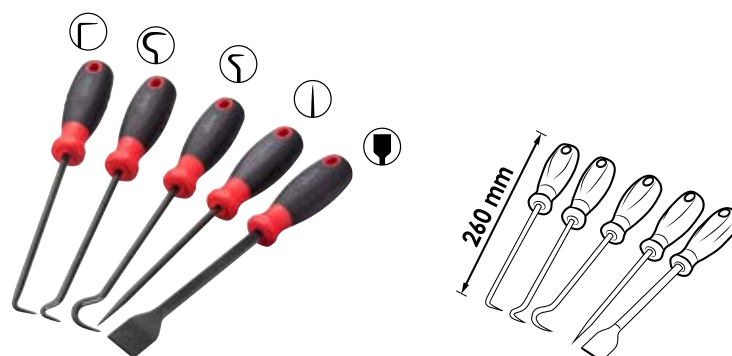

**34,10 €**  
zzgl. MwSt.



**V6210-4**, EAN 4047728065948

## Körner

- Markierung der zu bearbeiteten Komponenten
- Ergonomischer Zweikomponenten-Griff
- Sicherer Halt
- Reduzierung der Vibrationen beim Schlagen
- Verlängerter Schlagkopf
- Spitze Ø 4 mm
- Körner 4x10x185 mm



**8,15 €**  
zzgl. MwSt.

**V6210-10**, EAN 4047728065931

## Körner

- Markierung der zu bearbeiteten Komponenten
- Ergonomischer Zweikomponenten-Griff
- Sicherer Halt
- Reduzierung der Vibrationen beim Schlagen
- Verlängerter Schlagkopf
- Spitze Ø 10 mm
- Körner 10x12x185 mm



**10,50 €**  
zzgl. MwSt.

**V6230-5**, EAN 4047728065986

## Kreuzmeißel

- Sicheres, einfaches Trennen von Komponenten oder Bauteilen
- Ergonomischer Zweikomponenten-Griff
- Sicherer Halt
- Reduzierung der Vibrationen beim Schlagen
- Verlängerter Schlagkopf
- Klingenbreite: 5 mm
- Kreuzmeißel 5x10x170 mm



**9,30 €**  
zzgl. MwSt.

**V6230-7**, EAN 4047728065993

## Kreuzmeißel

- Sicheres, einfaches Trennen von Komponenten oder Bauteilen
- Ergonomischer Zweikomponenten-Griff
- Sicherer Halt
- Reduzierung der Vibrationen beim Schlagen
- Verlängerter Schlagkopf
- Klingenbreite: 7 mm
- Kreuzmeißel 7x12x190 mm



**11,65 €**  
zzgl. MwSt.

## V6200, EAN 4047728061940

### Splinttreiber Satz

- Ergonomischer 2-Komponenten-Griff
- Sicherer Halt
- Deutliche Reduzierung des Verletzungsrisikos dank Handschutz
- Reduzierung der Vibrationen beim Schlagen
- Verlängerter Schlagkopf
- 7 verschiedene Größen (Treibdorn  $\varnothing$  2 – 8 mm)
- Aufbewahrung in praktischer Rolltasche



VIGOR No.	$\varnothing$	L mm	EAN 4047728+	€
V6200-2	2	140	061957	8,35
V6200-3	3	150	061964	8,35
V6200-4	4	180	061971	8,35
V6200-5	5	200	061988	8,35
V6200-6	6	210	061995	8,35
V6200-7	7	210	062008	8,35
V6200-8	8	220	062015	9,55

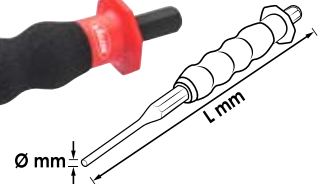

**58,70 €**  
zzgl. MwSt.

## V6220/4, EAN 4047728066006

### Flachmeißel Satz

- Sicheres, einfaches Trennen von Komponenten oder Bauteilen
- Ergonomischer Zweikomponenten-Griff
- Sicherer Halt
- Reduzierung der Vibrationen beim Schlagen
- Verlängerter Schlagkopf
- 4 verschiedene Größen: 10 · 16 · 20 · 29 mm
- Aufbewahrung in praktischer Rolltasche



VIGOR No.	L mm	Meißelhöhe mm	Meißelhöhe mm	EAN 4047728+	€
V6220-10	140	10	8	065955	8,15
V6220-16	170	16	10	065962	9,30
V6220-20	210	20	14	065979	16,35
V6220-29	250	29	18	063890	23,45

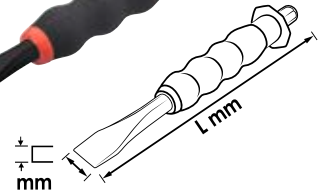

**58,- €**  
zzgl. MwSt.

## V6030, EAN 4047728060301

### Schaber Satz

- Entfernen von Plaketten, Aufklebern, Vignetten oder Kleberesten etc.
- Weitere Anwendungsbereiche: Entfernen von Motordichtungen, z.B. am Zylinderkopf oder Ventildeckel
- Einfaches Auswechseln der Klingen durch Lösen der Verschraubung am Spannfutter
- Verschiedene Klingen ermöglichen Anpassung auf unterschiedliche Anwendungsbereiche



VIGOR No.	Bezeichnung	mm	EAN 4047728+	€
V6030-12	Ersatzklingen	12	062121	3,65
V6030-16	Ersatzklingen	16	062138	3,65
V6030-20	Ersatzklingen	20	062145	3,65

**31,20 €**  
zzgl. MwSt.



## V1371, EAN 4047728069687

### Lösehebel Satz

- Filigrane Arbeiten an Türverkleidungen, Armaturenblech, Gummidichtungen, Zierleisten etc.
- Schlanke und stabile Ausführung
- Vielfältig einsetzbar in Werkstatt oder Haushalt



VIGOR No.	EAN 4047728+	€
V1371-1	069649	8,75
V1371-2	069700	8,75
V1371-3	069656	8,75
V1371-4	069694	8,75
V1371-5	069670	8,75
V1371-6	069632	8,75
V2491	024914	8,25
V2492	024921	8,25
V2493	024938	8,25
V2494	024945	8,25
V2495	024952	8,25

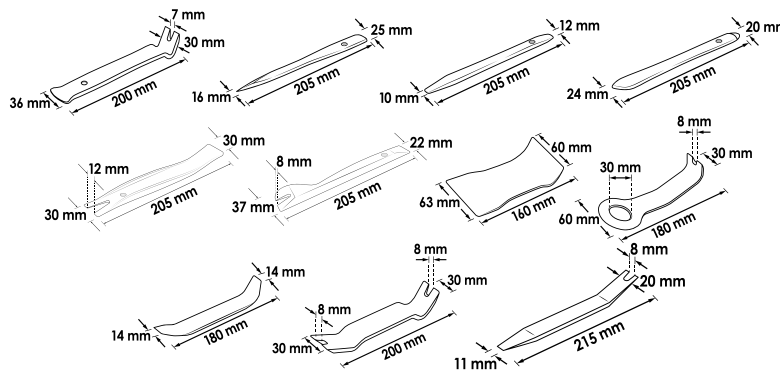

In praktischer Rolltasche



**40,65 €** zzgl. MwSt.

## V1369, EAN 4047728013697

### Lösehebel Satz

- Filigrane Arbeiten an Türverkleidungen, Armaturenblech, Gummidichtungen, Zierleisten etc.
- Verursacht keine Kratzer
- Schlanke und stabile Ausführung
- Vielfältig einsetzbar in Werkstatt oder Haushalt



VIGOR No.	l mm	b mm	EAN 4047728+	€
V2491	160	60	024914	8,25
V2492	180	30	024921	8,25
V2493	180	20	024938	8,25
V2494	200	30	024945	8,25
V2495	210	20	024952	8,25

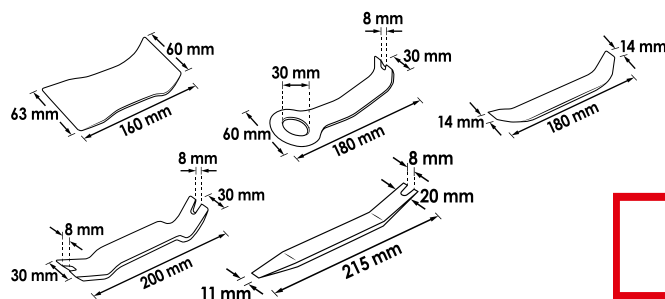

**32,85 €** zzgl. MwSt.

**V4885**, EAN 4047728**048859**

## Clip Löse Satz

- Metall- und Kunststoff-Clips von Fahrzeugverkleidungen
- Aufhängeloch

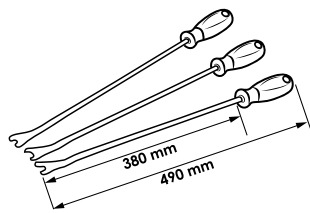

**55,30 €**  
zzgl. MwSt.

**V5885**, EAN 4047728**073851**

## Clip Löse Satz

- Metall- und Kunststoff-Clips von Fahrzeugverkleidungen
- Aufhängeloch

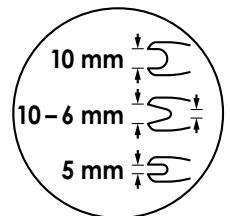
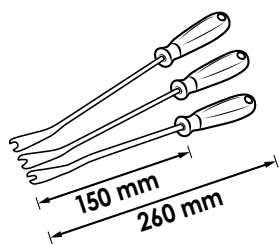

**35,55 €**  
zzgl. MwSt.

**V4310N**, EAN 4047728**062817**

## Lösehebel

- Schmale Bauart – zum Arbeiten in schwer zugänglichen Bereichen z.B. Demontage der Kunststoff-Clips von Tür- und Heckklappen-Verkleidungen
- Länge: 165 mm

Kunststoffschutz zum beschädigungsfreien Arbeiten

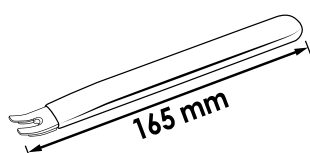

**15,50 €**  
zzgl. MwSt.



**V1301**, EAN 4047728013017

## Hebeleisen Satz

- Schlagfestes Heft



600 mm

450 mm

300 mm

200 mm

**42,35 €**  
zzgl. MwSt.

**V6952**, EAN 4047728069526

## Mini-Lösehebel Satz

- Batteriewechsel bei Autoschlüsseln oder Arbeiten am Armaturenbrett
- Handlich, fein und vielfältig einsetzbar

Beschädigungsfreies Arbeiten  
an lackierten Stellen



**24,70 €**  
zzgl. MwSt.

	L (mm)
1	190
2	185
3	185
4	165
5	170
6	170

**V5591**, EAN 4047728055918

## Bandmaß

- Millimetergenaue Ermittlung kurzer Distanzen bis 5 m
- Länge: 5 m, Breite: 19 mm
- Handschleife und Gürtelclip
- Magnetischer Anschlag
- Handregulierter Bändezug und Bandlaufperre
- Federbandstahl



**7,80 €**  
zzgl. MwSt.

**V1714**, EAN 4047728017145

## Fühlerlehren Satz

- Prüfen von Spaltmaßen, Kontaktabständen, Zwischenräumen
- Feststellmutter
- Blätter konisch zulaufend
- 20 Blatt
- 0,05 – 1,00 mm



**11,90 €**  
zzgl. MwSt.

# Diverse Handwerkzeuge Schneiden und Sägen



**V4690**, EAN 4047728046909

## Messschieber · analog

- Außen- und Innen-Messung im Bereich 0 – 150 mm
- Millimeter- und Zoll-Teilung
- Nonius 0,05 mm und  $\frac{1}{128}$ "
- Feststellschraube
- Tiefen-Messstab
- Im Kunststoffkasten
- DIN 862

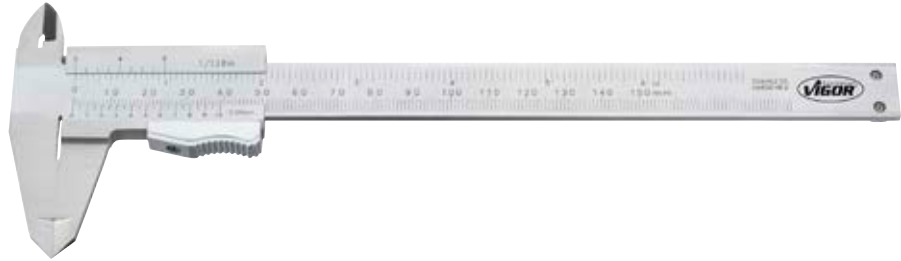

**36,10 €**  
zzgl. MwSt.

**V1713**, EAN 4047728017138

## Messschieber · digital

- Außen- und Innen-Messung im Bereich 0 – 150 mm
- Millimeter- und Zoll-Teilung
- Digitale Anzeige
- 1,5 V (LR 44) – 180 mAh
- Feststellschraube
- Tiefen-Messstab
- Im Kunststoffkasten



Umschaltung mm / inch

**48,35 €**  
zzgl. MwSt.

**V1304**, EAN 4047728013048

## Universalschere

- Lange, hochwertige Schneiden
- Klinge aus Edelstahl

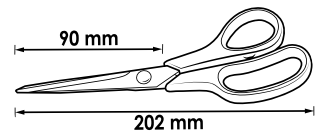

**7,10 €**  
zzgl. MwSt.

**V1715**, EAN 4047728017152

## Sägebogen

- Handelsübliche Sägeblätter

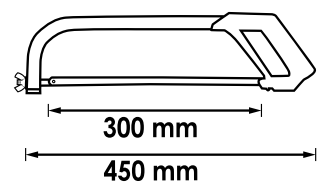

**19,30 €**  
zzgl. MwSt.



**V2790N**, EAN 4047728075664

## Handbügel-Säge · Klein

- Handelsübliche Sägeblätter

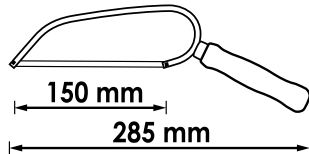
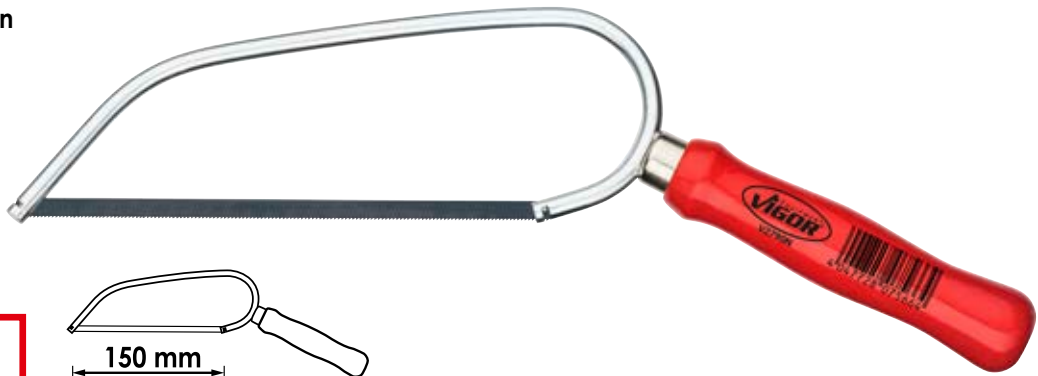

**11,05 €**  
zzgl. MwSt.

**V4651**, EAN 4047728046510

## Klappmesser · Outdoor

- Klingenlänge: 86 mm
- Gesamtlänge: 185 mm
- Klinge aus Edelstahl
- Griffgehäuse aus Aluminium



Mit Arretierung

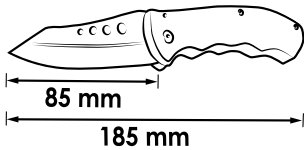

**19,20 €**  
zzgl. MwSt.



**V2627**, EAN 4047728026277

## Universalmesser

- Abbrechklinge 9 mm
- Gehäuse aus Edelstahl
- Taschen-Clip



**V4308**, EAN 4047728043083

## Abbrechklingen · 9 mm

- Klingen bestehen aus 12 Einzelklingen, die sich nach Verschleiß abtrennen lassen
- Für Universalmesser V2627

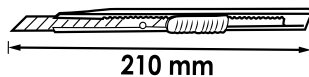

**3,85 €**  
zzgl. MwSt.



**2,45 €**  
zzgl. MwSt.

**V4275**, EAN 4047728042758

## Universalmesser

- Rutschfester Komfortgriff
- Stahlgeführte Klingenfixierung zur Unfallminimierung
- Schnellwechsel-Magazin
- Inklusive 6 Abbrechklingen (V4274)



**V4274**, EAN 4047728042741

## Abbrechklingen · 18 mm

- Klingen bestehen aus acht Einzelklingen, die sich nach Verschleiß abtrennen lassen
- Für Universalmesser V4275

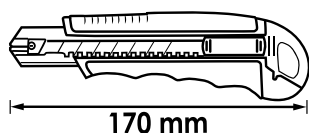

**8,90 €**  
zzgl. MwSt.



**2,80 €**  
zzgl. MwSt.



**V7099**, EAN 4047728070997

## Universal Klappmesser

- Universell einsetzbar in Lager, Garten, Haushalt, Werkstatt oder Industrie
- Einklappbar, daher verringertes Verletzungsrisiko
- Klingensicherung in offener Position
- Schneller Klappenwechsel
- Hochwertiges Aluminiumgehäuse

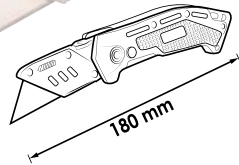

**12,- €**  
zzgl. MwSt.

**V1446**, EAN 4047728014465

## Trapez-Ersatzklingen

- Durch Trapezform 2-fach verwendbar
- Für Universalmesser V1345 · V7099
- Mit zwei Aufnahmen



**6,20 €**  
zzgl. MwSt.

**V7099/2**, EAN 4047728071123

## Universal Klappmesser Satz

- Universell einsetzbar in Lager, Garten, Haushalt, Werkstatt oder Industrie
- Einklappbar, daher verringertes Verletzungsrisiko
- Klingensicherung in offener Position
- Schneller Klappenwechsel
- Hochwertiges Aluminiumgehäuse

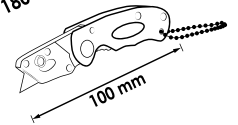
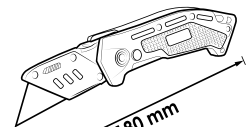

**17,55 €**  
zzgl. MwSt.

**V1345**, EAN 4047728013451

## Universalmesser

- Aluminiumgehäuse
- Schnellwechsel-Magazin
- Inklusive 10 Trapez-Ersatzklingen (V1446)

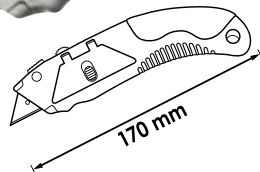

**19,10 €**  
zzgl. MwSt.

**V1446**, EAN 4047728014465

## Trapez-Ersatzklingen

- Durch Trapezform 2-fach verwendbar
- Für Universalmesser V1345 · V7099
- Mit zwei Aufnahmen



**6,20 €**  
zzgl. MwSt.



**V1787**, EAN 4047728017879

## Flachstumpf-Feile

- Zahnung (Hieb): 2 = mittel
- DIN 7261

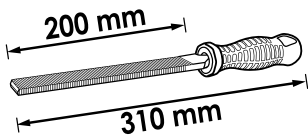

**13,55 €**  
zzgl. MwSt.

**V1788**, EAN 4047728017886

## Dreikant-Feile

- Zahnung (Hieb): 2 = mittel
- DIN 7261

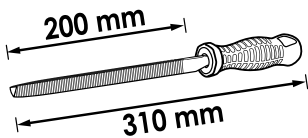

**13,55 €**  
zzgl. MwSt.

**V1789**, EAN 4047728017893

## Vierkant-Feile

- Zahnung (Hieb): 2 = mittel
- DIN 7261

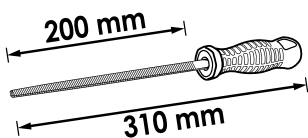

**13,55 €**  
zzgl. MwSt.

**V1790**, EAN 4047728017909

## Halbrund-Feile

- Zahnung (Hieb): 2 = mittel
- DIN 7261

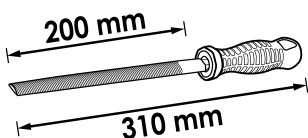

**15,90 €**  
zzgl. MwSt.

**V1801**, EAN 4047728018012

## Rund-Feile

- Zahnung (Hieb): 2 = mittel
- DIN 7261

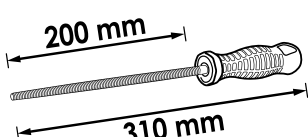

**13,55 €**  
zzgl. MwSt.

**V2626**, EAN 4047728026260

## Rohrschneider

- Für Rohre aus Kupfer, Messing, Leichtmetall und PVC-Hartkunststoff

Ø 3 – 16 mm



**16,- €**  
zzgl. MwSt.

**V3309**, EAN 4047728033091

## Ratschen-Rohrschneider für Auspuff

- Schneidet Edelstahl, Stahl, Kupfer, Aluminium
- Ratschenfunktion:
  - Erlaubt Arbeiten auch an schwer zugänglichen Stellen
  - Erübrigt Führung des Abschnidegriffes um das Rohr
- Arbeitsbereich: 32 – 67 mm
- Schnitttiefe: 3 mm



**180,50 €**  
zzgl. MwSt.

**V3451**, EAN 4047728034517

## Ersatzklingen

- Ersatzklingen für Auspuff-Ratschenrohrschneider V3309



**9,90 €**  
zzgl. MwSt.

**V1707**, EAN 4047728017077

## HSS-Stufenbohrer Satz

VIGOR No.	Ø mm	l mm	EAN 4047728+	€
V2394	4-12	65	023948	24,70
V2395	4-20	75	023955	32,15
V2396	4-30	100	023962	87,35



**138,- €**  
zzgl. MwSt.

**V6809-4**, EAN 4047728067720

## Drahtbürste · Stahl · 4-reihig

- Bearbeiten von Stahl
- Stahlborsten
- Draht: 0,30 mm



**4,70 €**  
zzgl. MwSt.

**V6807-4**, EAN 4047728067713

## Drahtbürste · Messing · 4-reihig

- Schonende Bearbeitung empfindlicher Oberflächen
- Messingborsten
- Draht: 0,30 mm



**7,35 €**  
zzgl. MwSt.



**V6800-50**, EAN 4047728067621

## Topfbürste · grob

- Beseitigung von groben Belägen und Rückständen sowie starkem Rost
- Stahldraht
- 6 mm Einspannschaff
- Maximal 4500 U/min
- 50 mm Ø
- Besatzhöhe 17 mm

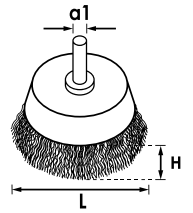

**3,75 €**  
zzgl. MwSt.

**V6800-75**, EAN 4047728067638

## Topfbürste · grob

- Beseitigung von groben Belägen und Rückständen sowie starkem Rost
- Stahldraht
- 6 mm Einspannschaff
- Maximal 4500 U/min
- 75 mm Ø
- Besatzhöhe 20 mm

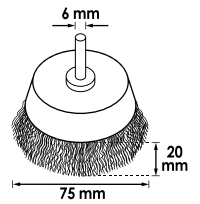

**4,45 €**  
zzgl. MwSt.

**V6802**, EAN 4047728067645

## Pinselkopfbürste

- Entgraten, Entlacken, Entrosten und Reinigen
- Stahldraht
- 25 mm Ø
- 6 mm Einspannschaff
- Maximal 4500 U/min

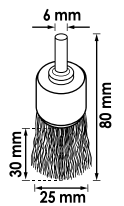

**5,65 €**  
zzgl. MwSt.

**V6803-100**, EAN 4047728067669

## Scheibenbürste

- Entfernen von Anlassarfarbe an Schweißnähten
- Stahldraht
- 6 mm Einspannschaff
- Maximal 4500 U/min
- 100 mm Ø

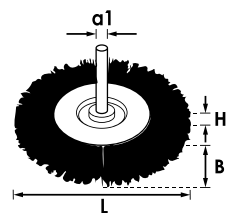

**7,35 €**  
zzgl. MwSt.

**V6803-75**, EAN 4047728067652

## Scheibenbürste

- Entfernen von Anlassarfarbe an Schweißnähten
- Stahldraht
- 6 mm Einspannschaff
- Maximal 4500 U/min
- 75 mm Ø

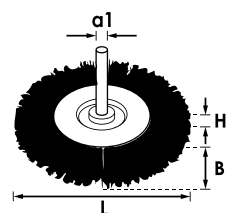

**6,15 €**  
zzgl. MwSt.

**V6806**, EAN 4047728067676

## Scheibenbürste · gezopft

- Beseitigung von groben Belägen und Rückständen sowie starkem Rost oder Verzunderungen
- Stahldraht
- Gezopfte Ausführung
- 75 mm Ø
- Maximal 12500 U/min

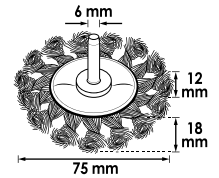

**10,60 €**  
zzgl. MwSt.

**V6804**, EAN 4047728067690

## Scheibenbürste

- Entgraten, Entlacken, Entrosten und Reinigen
- Gehärteter Stahldraht
- Gezopfte Ausführung
- 115 mm Ø
- Maximal 12500 U/min

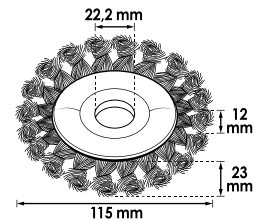

**13,35 €**  
zzgl. MwSt.

**V6805**, EAN 4047728067706

## Kegelbürste

- Kegelform für schwer zugängliche Stellen
- Gehärteter Stahldraht
- Gezopfte Ausführung
- 100 mm Ø
- Gewinde: M 14 x 2,0
- Maximal 12500 U/min

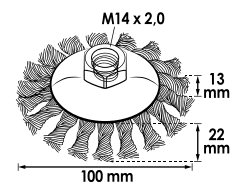

**11,05 €**  
zzgl. MwSt.

**V6801-65**, EAN 4047728067683

## Topfbürste

- Schwere Bürstarbeiten auf größeren Flächen sowie zum Entgraten, Entrosten und Reinigen
- Stahldraht
- Gezopfte Ausführung
- 65 mm Ø
- Gewinde: M 14 x 2,0
- Maximal 12500 U/min

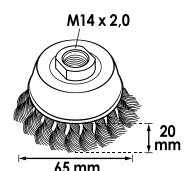

**10,60 €**  
zzgl. MwSt.





**Drehmoment-  
Werkzeuge**

## Drehmomentschlüssel

- Drehmoment-Auslösung: Haptisch und akustisch
- $\pm 4\%$  Auslöse-Genauigkeit vom Skalenwert (in Betätigungsrichtung)
- Mit Seriennummer und Zertifikat
- DIN EN ISO 6789-2:2017, DIN 3120, ISO 1174-1A
- 72 Zähne
- $5^\circ$  Betätigungswinkel



Drehmoment-Technik „Made in Germany“

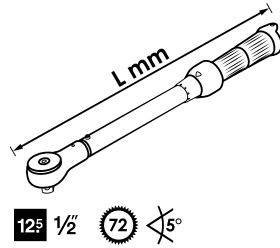

Kein Zurückdrehen mehr nötig

VIGOR No.	Nm	12.5 1/2	L mm	Toleranz	EAN 4047728+	€
V3898	20 - 120	12.5 1/2	445	4	038980	146,-
V3441	40 - 200	12.5 1/2	540	4	034418	146,-
V3899	60 - 320	12.5 1/2	610	4	038997	167,-

Feinverzahnte Umschaltknarre



Skalenteilung: 1 Nm



Doppelskala: Nm und lbf.ft.



Griff mit Aufhängöse



V2795, EAN 4047728027953

## Drehwinkel-Messgerät

- Feinauflösung (0,1°)
- Drehwinkelbereich bis 999° (addierend)
- Winkelmessungen gegen und im Uhrzeigersinn
- 99 Speicherplätze
- Anzeige für Batterieladestatus
- LED-Alarmanzeige (blinkend)
- Summeralarm-Anzeige
- Akustischer Warnton
- Automatische Abschalfunktion



**162,50 €**  
zzgl. MwSt.





## Pneumatik-Werkzeuge

Schlagschrauber

231-232

Luftratschen

233

Stabschleifer

234

Pneumatik-Pistolen

235  
237

Schlauchaufroller

236



**V5671N**, EAN 4047728076715

## Schlagschrauber · Mini

- Kompakte Bauweise für beengte Platzverhältnisse
- Mehrstufiger Rechts- / Linkslauf mit Einhand-Umstellung
- Ablufführung durch Handgriff nach unten
- Kälteisolierender Griff
- Hochleistungs-Jumbohammer-Schlagwerk
- Ergonomisch geformter Handgriff und Gehäuse für verbesserte Handhabung und Bedienung
- Stoßfänger an der Gehäusesseite schützt den Luftmotor

12<sup>5</sup> 1/2"

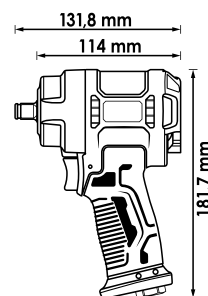

**Maximales Lösemoment  
1200 Nm**



12.91(4) 7.2

Inklusive Kupplungsstecker

VIGOR No.	12 <sup>5</sup> 1/2"	max. Nm	Nm	Nm	1/min	kg	Ø mm	l/min	bar	dB (A)	m/s <sup>2</sup>	EAN 4047728+	€
V5671N	12 <sup>5</sup> 1/2"	850	600	1200	10000	1.28	10	141.5	6.3	95.3	6.81	076715	130,-

**V4800N**, EAN 4047728075633

## Schlagschrauber

- Ablufführung durch Handgriff nach unten
- Kälteisolierender Griff
- Hochleistungs-Doppelhammer-Schlagwerk
- Ergonomisch geformter Handgriff und Gehäuse für verbesserte Handhabung und Bedienung
- Stoßfänger an der Gehäusesseite schützt den Luftmotor

**ECO GIANT**



12<sup>5</sup> 1/2"



**Hochleistungs-Doppelhammer-Schlagwerk**

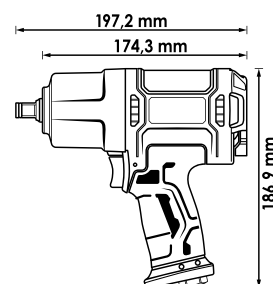

**Maximales Lösemoment:  
1720 Nm**



12.91(4) 7.2

Inklusive Kupplungsstecker

VIGOR No.	12 <sup>5</sup> 1/2"	max. Nm	Nm	Nm	1/min	kg	Ø mm	l/min	bar	dB (A)	m/s <sup>2</sup>	EAN 4047728+	€
V4800N	12 <sup>5</sup> 1/2"	1100	850	1720	7000	2.3	10	198.1	6.3	96.7	6.47	075633	107,-



**V6899N**, EAN 4047728**076944**

## Schlagschrauber

- Mehrstufiger Rechts- / Linkslauf mit Einhand-Umstellung
- Kälteisolierender Griff
- Abluftführung durch Handgriff nach unten
- Hochleistungs-Doppelhammer-Schlagwerk
- Ergonomisch geformter Handgriff und Gehäuse für verbesserte Handhabung und Bedienung
- Stoßfänger an der Gehäuseseite schützt den Luftmotor



**20** 3/4"



**Hochleistungs-Doppelhammer-Schlagwerk**

**Maximales Lösemoment  
2300 Nm**

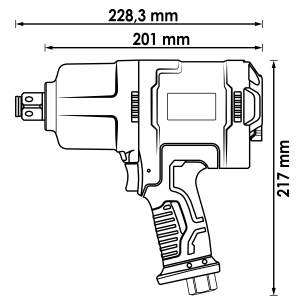

12.91 (w) 7.2

Inklusive Kupplungsstecker

VIGOR No.	max. Nm	Nm	Nm	1/min	kg	Ø mm	l/min	bar	dB (A)	m/s <sup>2</sup>	EAN	€
V6899N	2000	1400	2300	5500	3.6	13	254.8	6.3	97.9	5.75	4047728+076944	199,-

**V3653**, EAN 4047728**036535**

## Schlagschrauber

- Mehrstufiger Rechts- / Linkslauf mit Einhand-Umstellung
- Abluftführung durch Handgriff nach unten
- Kälteisolierender Griff
- Hochleistungs-Doppelhammer-Schlagwerk
- Ergonomisch geformter Handgriff und Gehäuse für verbesserte Handhabung und Bedienung

**GIGA GIANT**



**12<sup>5</sup>** 1/2"



**Hochleistungs-Doppelhammer-Schlagwerk**

**Maximales Lösemoment:  
1890 Nm**



Mehrstufiger Rechts-/ Linkslauf mit Einhand-Umschaltfunktion

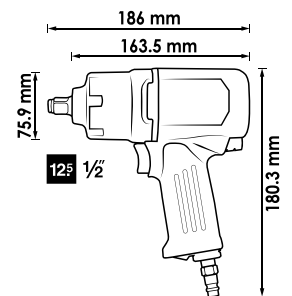

12.91 (w) 7.2

Inklusive Kupplungsstecker

VIGOR No.	max. Nm	Nm	Nm	1/min	mm	kg	Ø mm	l/min	bar	dB (A)	m/s <sup>2</sup>	EAN	€
V3653	1290	700	1890	8500	186	1.95	10	113	6.3	96	12.92	4047728+036535	306,-

## V5674, EAN 4047728056748

### Luftratsche

- Für beengte Platzverhältnisse
- Umschaltfunktion am Ratschenkopf

**QUICKGIANT**

**6.3** 1/4"



12,91 (€) 7.2

Inklusive Kupplungsstecker

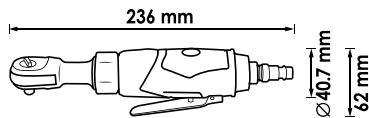

VIGOR No.		max. Nm	1/min	L mm	kg	Ø mm	l/min	bar	dB (A)	m/s <sup>2</sup>	EAN 4047728+	€
V5674	6.3 1/4"	35.2	240	236	0.6	10	77	6.3	87.5	3.47	056748	71,05

## V6554, EAN 4047728065542

### Luftratsche

- Für beengte Platzverhältnisse
- Umschaltfunktion am Ratschenkopf

**QUICKGIANT**

**10** 3/8"



12,91 (€) 7.2

Inklusive Kupplungsstecker

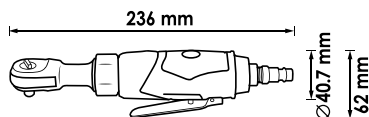

VIGOR No.		max. Nm	1/min	L mm	kg	Ø mm	l/min	bar	dB (A)	m/s <sup>2</sup>	EAN 4047728+	€
V6554	10 3/8"	35.2	240	236	0.6	10	77	6.3	87.5	3.47	065542	68,70

## V5675, EAN 4047728056755

### Luftratsche

- Für beengte Platzverhältnisse
- Umschaltfunktion am Ratschenkopf

**QUICKGIANT**

**12.5** 1/2"



12,91 (€) 7.2

Inklusive Kupplungsstecker

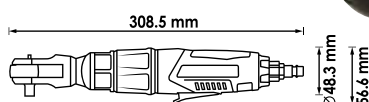

VIGOR No.		max. Nm	1/min	L mm	kg	Ø mm	l/min	bar	dB (A)	m/s <sup>2</sup>	EAN 4047728+	€
V5675	12.5 1/2"	67	160	308.5	1.2	10	114	6.3	100.5		056755	99,-



## V5672, EAN 4047728056724

### Stabschleifer · gerade

- Fräser, Trennscheiben, Schleifkörper mit 3 und 6 mm Spannfutter

3 + 6 mm



Inklusive Ø 3 mm Spannfutter

Inklusive Ø 6 mm Spannfutter

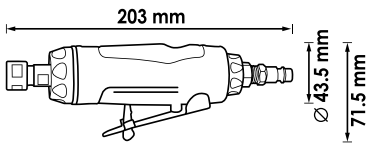

**SPEED GIANT**

12.91 (6) 7.2

Inklusive Kupplungsstecker



VIGOR No.	mm	1/min	mm	W Watt	kg	Ø mm	l/min	bar	dB (A)	m/s <sup>2</sup>	EAN 4047728+	€
V5672	3-6 mm	22000	203	350	0.54	10	128.2	6.3	97.1	2.90	056724	58,25

## V5673, EAN 4047728056731

### Stabschleifer · abgewinkelt

- Fräser, Trennscheiben, Schleifkörper mit 3 und 6 mm Spannfutter

3 + 6 mm



Inklusive Ø 3 mm Spannfutter

Inklusive Ø 6 mm Spannfutter

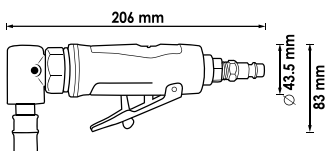

**SPEED GIANT**

12.91 (6) 7.2

Inklusive Kupplungsstecker



VIGOR No.	mm	1/min	mm	W Watt	kg	Ø mm	l/min	bar	dB (A)	EAN 4047728+	€
V5673	3-6 mm	20000	206	250	0.45	10	85.5	6.3	101.6	056731	86,15

## V6906, EAN 4047728069069

### Stabschleifer Satz · Mini

- Gerade Ausführung
- Kleine Ausführung für beengte Platzverhältnisse
- Zum Schleifen, Polieren oder Entgraten
- Inklusive Spannfutter für 3 und 6 mm Aufnahmen
- Ablufführung durch Handgriff nach unten
- Inklusive 10-teiligem Schleifstein Satz V6906-10

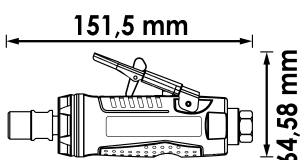

**SPEED GIANT**

12.91 (6) 7.2

Inklusive Kupplungsstecker

## V6906-10, EAN 4047728069571

### Schleifstein Satz

- Schleifsteine für VIGOR Stabschleifer V6906 · V5672 · V5673



**11,90 €**

VIGOR No.	mm	1/min	W Watt	kg	Ø mm	l/min	bar	dB (A)	EAN 4047728+	€
V6906	3-6 mm	25000	185	0.31	10	85	6.3	102	069069	54,15

**V6905**, EAN 4047728069052

## Reifenfüller

- Einhandbedienung mit ergonomischem Griff
- Gummiummanteltes Manometer zum Schutz vor leichten Stößen
- Leicht ablesbares Präzisionsmanometer mit bar und PSI-Angabe
- Teilung: 0,1 bar
- Gut dosierbarer Füllhebel und Ablassknopf, einfach am Handgriff erreichbar
- Ablassknopf zur Nivellierung der Befüllmenge

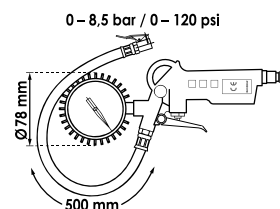

**19,80 €**  
zzgl. MwSt.

**V7135**, EAN 4047728071352

## Ausblas-Pistole · kurz

- Schnelles Säubern oder Entfernen von Spänen und anderen Fremdkörpern
- Langlebiges Aluminium Gehäuse
- Aufhängevorrichtung eingearbeitet

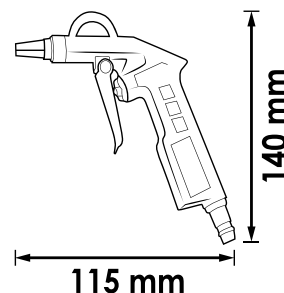

**11,55 €**  
zzgl. MwSt.

**V7135-150**, EAN 4047728071369

## Ausblas-Pistole · lang

- Schnelles Säubern oder Entfernen von Spänen und anderen Fremdkörpern
- Langlebiges Aluminium Gehäuse
- Aufhängevorrichtung eingearbeitet

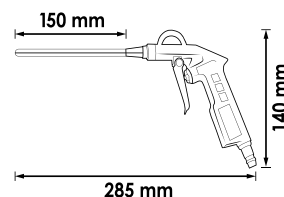

**15,05 €**  
zzgl. MwSt.



V7143-10, EAN 4047728071437

## Schlauchaufroller

- Reduziert Unfallgefahr, da kein Schlauch herumliegt
- Kompaktes Gehäuse, inklusive Öffnungsklappe zur Beseitigung von Schmutz oder zum Richten des Schlauches
- Wandhalterung: 180° schwenkbar
- Automatisches Aufrollen durch geführten Einzugs
- Druckluftadapter vorinstalliert
- Hybrid Polymer-Schlauch
- Auto Stop Funktion
- Schlagfestes Gehäuse aus Polypropylen
- Angepasste Einzugskraft
- Betriebsdruck maximal: 12 bar

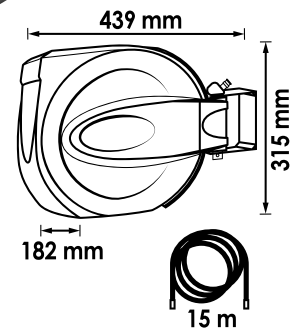

**118,50 €**  
zzgl. MwSt.



**V4322**, EAN 4047728043229

## Unterbodenschutz-Pistole

- Für handelsübliche 1000 ml Kartuschen
- Belliegender flexibler 500 mm-Schlauch mit Spreizdüse für Rundum-Wachsnebel ermöglicht problemlosen Wachsaufrag in Hohl- und Zwischenräumen
- Einfaches Auftragen des Unterbodenschutzes (bzw. Schallschutz) mit standardmäßig installierter Düse
- Anwendungstipp: Kartusche öffnen, Ansaugrohr eintauchen, Kartusche festschrauben. Fertig.

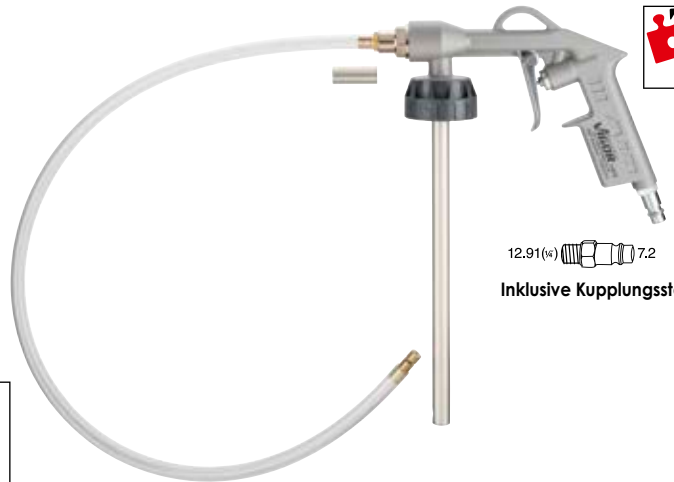

12.91(e) 7.2

Inklusive Kupplungsstecker



**36,20 €**  
zzgl. MwSt.

**V6907**, EAN 4047728075497

## Mini-Fettpresse

- Einfaches Wechseln der Fetttube durch Schraubgewinde
- Fördermenge: 0,45 ml/Hub
- Schmiernippel in 30° und 90° Ausführung
- Innengewinde M15 x 1,5



**24,95 €**  
zzgl. MwSt.

**V6907-1**, EAN 4047728075503

## Hochleistungs-Fett

- Fetten von Schlagwerken, Spindeln und Verschraubungen
- Austausch-Fetttube für V6907
- Korrosionsschutz durch gute Haft Eigenschaften auf metallischen Oberflächen
- Füllmenge: 100 ml
- Außengewinde: M 15 x 1,5



**7,45 €**  
zzgl. MwSt.





**Allgemeiner  
Werkstattbedarf**



**V4241**, EAN 4047728**042413**

## Schaltschrankschlüssel Sub Maker Quadro 10-in-1

- Für fast alle gängigen Schließungen in Sanitär, Heizung, Bau, Lüftung, Klima etc.

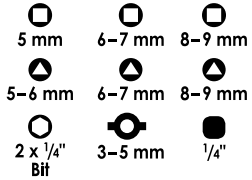

**MADE IN GERMANY**

**28,60 €**  
zzgl. MwSt.

**V4228**, EAN 4047728**042284**

## Baustellenschlüssel MasterKey Bau

- Für gängige Schließungen in Sanitär, Heizung, Bau, Lüftung, Klima etc.
- Vierkant-Dorn ermöglicht Betätigen der Schloßnuss ohne Türdrücker und Vierkantschlüssel

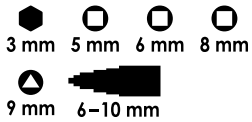

**MADE IN GERMANY**

Zinkdruckguss

**18,85 €**  
zzgl. MwSt.

**V4227**, EAN 4047728**042277**

## Baustellenschlüssel MasterKey Elektro

- Für fast alle gängigen Schließungen in Sanitär, Elektro, Heizung, Lüftung, Klima etc.

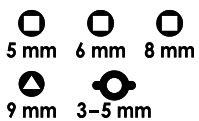

**MADE IN GERMANY**

Zinkdruckguss

**19,45 €**  
zzgl. MwSt.



**V4279**, EAN 4047728**042796**

## Japanspachtel Satz · Metall

- Auftragen von Material bzw. zum Glätten von Oberflächen sowie zum Einsatz in vielen weiteren Anwendungsbereichen
- Breite Spachtel 50 · 80 · 100 · 120 mm

MADE IN GERMANY



Aus hochflexiblem  
Federbandstahl



**7,90 €**  
zzgl. MwSt.

**V4278**, EAN 4047728**042789**

## Japanspachtel Satz · Kunststoff

- Auftragen von Material bzw. zum Glätten von Oberflächen sowie zum Einsatz in vielen weiteren Anwendungsbereichen
- Für Arbeiten im Karosseriebereich, z.B. Verfüllen von Löchern und Dellen sowie vielen weiteren Anwendungsbereichen
- Breite Spachtel 50 · 80 · 100 · 120 mm

MADE IN GERMANY



**7,90 €**  
zzgl. MwSt.

**V5480**, EAN 4047728**054799**

## Teleskopspiegel Satz

- Sichtprüfung an schwer zugänglichen Stellen
- Federgespanntes Doppelgelenk zur Einsicht in unsichtbaren Bereichen
- Spiegel austauschbar über Schnellwechsel-System mit 6,3 mm Aufnahme

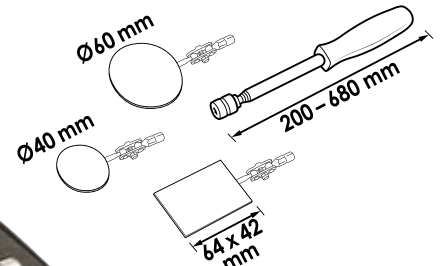

Spiegel austauschbar über  
Schnellwechsel-System



Schnelle Identifikation von  
z.B. Ölverlust, Korrosion  
oder Steckverbindungen

**63,60 €**  
zzgl. MwSt.

**V1740**, EAN 4047728068673

## Magnetheber · semi-flexibel

- Ausziehbarer Magnet zur punktuellen Aufnahme
- Hochwertiger Kunststoffgriff
- Semi-flexibler Schaft



**30,90 €**  
zzgl. MwSt.

**V1741**, EAN 4047728017411

## Teleskop-Magnetheber

- Aufnehmen von eisenhaltigen Teilen auch an unzugänglichen Stellen
- Ausziehbar
- Praktischer Taschen-Clip



**14,30 €**  
zzgl. MwSt.

**V1764**, EAN 4047728017640

## Krallengreifer mit Magnet · flexibel

- Aufnehmen von Kleinteilen wie Schrauben, Muttern etc. an unzugänglichen Stellen
- Mit Magnet für zusätzlichen Halt
- Greif- und Magnetfunktion



**22,70 €**  
zzgl. MwSt.

**V1438**, EAN 4047728014380

## Pinzetten Satz

- Filigrane Arbeiten z.B. an schwer zugänglichen Stellen
- Hohe Griffigkeit
- Edelstahl



**11,90 €**  
zzgl. MwSt.



**V5512**, EAN 4047728055123

## Gas LötKolben Satz

- Löt-, Schmelz-, Schrumpf-, Heißschneid-Arbeiten durch sieben verschiedene Adapter
- Flexibler, autarker Einsatz durch Gasbetrieb
- Gerät kombiniert drei Funktionen in einem:
  - LötKolben, maximale Temperatur: 450° C
  - Brenner, maximale Temperatur: 1300° C
  - Heißluftfön, maximale Temperatur: 600° C
- Klein und handlich zur Durchführung direkter Arbeiten, z.B. am Fahrzeug
- Stufenlose Gasregulierung zur optimalen Einstellung auf durchzuführende Arbeit und Material
- Flamm-Temperatur maximal: 1300° C
- Standfuß für stationäres Arbeiten
- Piezozündung
- Befüllung mit handelsüblichem Feuerzeug- / ISO-Butangas
- Inhalt:
  - Gas-LötKolben
  - Lötspitze 3,5 mm
  - Lötspitze 4,5 mm
  - Schrumpfschlauch-Aufsatz
  - Schneid-Spitze
  - Lötschwamm Schutzkappe
  - Lötendraht



Verbesserte Lötspitzen Füllstandanzeige



Gasventil



Edelstahl



Überall flexibel einsetzbar durch Gasbetrieb

**75,55 €**  
zzgl. MwSt.

**V5488**, EAN 4047728054881

## Mehrzweckwanne · 50 l

- Einsatz als Reinigungswanne, Schmutzwanne, Ölwanne, Aufbewahrungswanne, Desinfektionswanne, Leckagewanne, Transportwanne und Futterwanne z.B. im Sanitär- und Heizungsbau, Kfz-Industrie- und Werkstatt, Jagdbedarf, Chemie/Labor, Lebensmittelindustrie / Fleischerei, Angelsport, Tierbedarf, Pferdezubehör usw
- Lauge- und säurefest

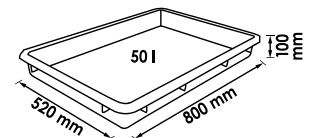

Universell einsetzbar mit großem Fassungsvermögen

**69,55 €**  
zzgl. MwSt.

**V5677**, EAN 4047728056779

## Magnetschale mit Kunststoff-Rahmen

- Zwei starke Magnete zur Befestigung an Hebebühnen, Werkstattwagen, Maschinen, etc
- Ablegen von magnetischen und nicht-magnetischen Kleinteilen – freie Hände zum Arbeiten
- Kunststoff-Rahmen bietet Ablagefläche für Kunststoffschrauben o.ä. und dient dadurch zusätzlich als Auffangschale
- Kleinteile werden gut sichtbar und wieder auffindbar abgelegt

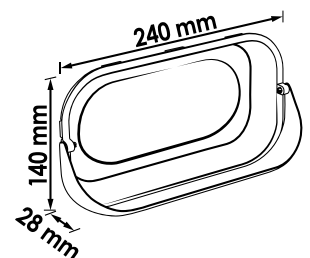

Kleiner Helfer für große Ordnung

**21,- €**  
zzgl. MwSt.

**V5678**, EAN 4047728070539

## Magnet-Halbschale

- Aufbewahrung von Schrauben, Dichtungen oder Kleinteilen
- Befestigung an Werkstattwagen, Hebebühnen oder Metallschränken
- Für die Werkstatt, Produktionsstätte oder den Hobbykeller
- Stabiles Kunststoffgehäuse mit optimiertem Magneten
- Große Öffnung für gute Sicht in die Halbschale
- Gummischutz am Magneten verhindert Beschädigungen
- Magnetschale beidseitig magnetisch – magnetische Kleinteile haften an der Rückwand
- Zusätzliche Stabilisierung unterhalb des Magneten für planes Aufliegen der Halbschale
- Magnethaltkraft: circa 2,5 kg

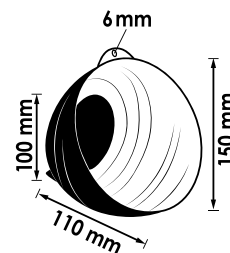

**8,30 €**  
zzgl. MwSt.



**V6468**, EAN 4047728064682

## Düseninsteller mit Magnet

- DüsenEinstellung von Scheibenwaschanlagen
- Zusätzliche Funktion als Magnetheber
- Taschen-Clip



Schmale Einstecknadel Ø 0,6 mm

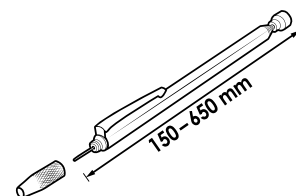

**Inklusive Display bei einer Abnahme von mindestens 16 Stück**

**15,20 €**  
zzgl. MwSt.



**V7221**, EAN 4047728072212

## Waschdüsen-Einstellwerkzeug · MERCEDES-BENZ

- Beschädigungsfreies Einstellen von Fächerdüsen der Scheibenwaschanlage an MERCEDES-BENZ W204 · W207 · W212 · W218
- Optimales Einstellen von Fächerdüsen der Scheibenwaschanlage an MERCEDES-BENZ
- Passgenaues Düsenkopf Profil
- Außensechskanttrieb: 6 mm
- Für folgende Modelle: W204 · W207 · W212 · W218
- Gesamtlänge: 67 mm

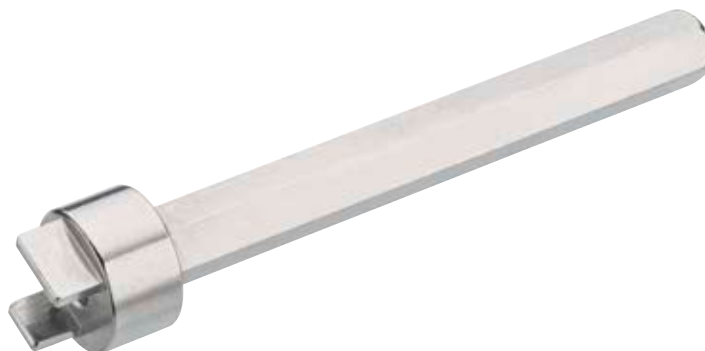

**17,35 €**  
zzgl. MwSt.



**V6742**, EAN 4047728067423

## Werkzeug-Magnethalter

- Lagerung von Krafteinsätzen, Schlagschraubern, Drehmomentschlüsseln oder Schläuchen direkt an Ort und Stelle
- Starke Magneten (Ø je 80 mm) garantieren guten Halt an Hebebühnen, Werkstattwagen oder weiteren eisenhaltigen Untergründen
- Magnethaltekraft: circa 20 kg



Optimale Lagerung von Krafteinsätzen und Schlagschraubern direkt an Ort und Stelle

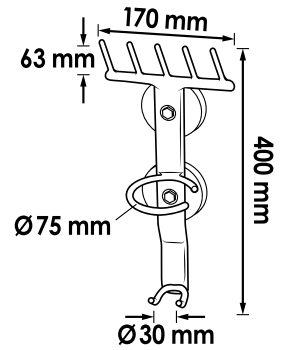

**35,40 €**  
zzgl. MwSt.

**V6605**, EAN 4047728066051

## Koffügeschoner

- Schutz vor Beulen, Kratzern, Öl und Schmutz
- Universalgröße
- Kein Verdecken der Räder

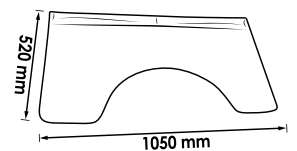

**37,20 €**  
zzgl. MwSt.

**V6606**, EAN 4047728066068

## Mehrweg-Sitzschoner

- Schutz des Autositzes vor Verschmutzung
- Universalgröße, für die meisten Pkw und gängige Nutzfahrzeuge
- Leichtes Nylon, PU-beschichtet
- Wasser-, fett- und ölabweisend
- Inhalt: 1 Stück
- Waschbar bei 40° C

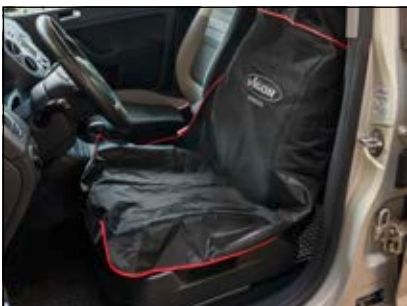

Maße: L: 1350 x B: 760 mm

**21,60 €**  
zzgl. MwSt.

## Arbeitshandschuhe

- Montagearbeiten in der Werkstatt, Lager / Logistik und überall dort, wo hohe Griffsicherheit und Präzision wichtig sind
- Leichte Polyester-Strickhandschuhe mit ergonomischer Passform
- EN 388:2003 (3131A)



Schwarze PU-Beschichtung auf der Handinnenfläche

VIGOR No.	Handschuhgröße	EAN 4047728+	€
V6435	9 / L	064354	1,70
V6435-XL	10 / XL	069984	1,60

## Handschuhe · Grip

- Schützen die Hände vor Öl, Fett, Chemikalien und Dreck
- Oberflächenstruktur bietet gute Haftung, auch bei öligen Arbeitsbedingungen
- Sicherheitsfarbe orange für bessere Erkennbarkeit in dunklen Arbeitsräumen
- Komfortabler, reißfester Handschuh mit gutem Fingerspitzengefühl
- Touchscreen-kompatibel
- Material: Nitril
- Materialstärke: 7 Mil (entspricht 0,18 mm)
- Latex- und pulverfrei



V6436-M 100 Stk./Karton  
 V6436-L 100 Stk./Karton  
 V6436-XL 90 Stk./Karton  
 V6436-XXL 90 Stk./Karton

VIGOR No.	Handschuhgröße	EAN 4047728+	€
V6436-M	8 / M	080118	44,30
V6436-L	9 / L	077712	44,30
V6436-XL	10 / XL	077729	44,30
V6436-XXL	11 / XXL	077736	44,30



**V2338**, EAN 4047728023382

## Kniekissen

- Komfortables Arbeiten in der Werkstatt, Industrie, Garten oder Haushalt
- Hochwertiger Schaumstoff
- Knieschonend
- Wärmeisolierend
- Wasser- und Ölabweisend
- Mit Tragegriff

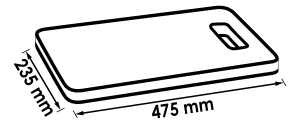

*Komfortables und gelenkschonendes Arbeiten in der Werkstatt, Industrie, im Garten oder Haushalt*

**22,20 €**  
zzgl. MwSt.

**V6973**, EAN 4047728069731

## Montage-Rollbrett

- Gepolstertes Kopfteil
- Zwei seitliche Ablagefächer für Schrauben oder andere Kleinteile
- Hochwertige Verarbeitung aus Kunststoff
- Leicht zu reinigen
- Sechs Hartkunststoff-Rollen
- Belastbarkeit maximal 150 kg

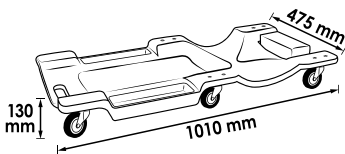

Bequemes Arbeiten unter dem Fahrzeug



**85,15 €**  
zzgl. MwSt.

**V6973-1**, EAN 4047728069748

## Ersatzrolle für Montage-Rollbrett



**10,60 €**  
zzgl. MwSt.





**V4646**, EAN 4047728**046466**

## Bürsten Satz

- Professionelles Reinigen und Entgraten von Zylindern, Röhren, Buchsen etc.
- Für Betrieb mit Bohrmaschinen und Druckluftbohrern (Bei Maschinenverwendung nur rechtslaufend einsetzen)
  - 12 Nylonbürsten: Ø 8 · 9 · 10 · 11 · 12 · 13 · 14 · 15 · 16 · 17 · 18 · 19 mm
  - 12 Stahlbürsten: Ø 8 · 9 · 10 · 11 · 12 · 13 · 14 · 15 · 16 · 17 · 18 · 19 mm
  - 12 Bürsten mit Messingbeschichtung: Ø 8 · 9 · 10 · 11 · 12 · 13 · 14 · 15 · 16 · 17 · 18 · 19 mm
  - 1 Handgriff mit Aufnahme und Schnellverriegelung
  - 1 Verlängerung 150 mm

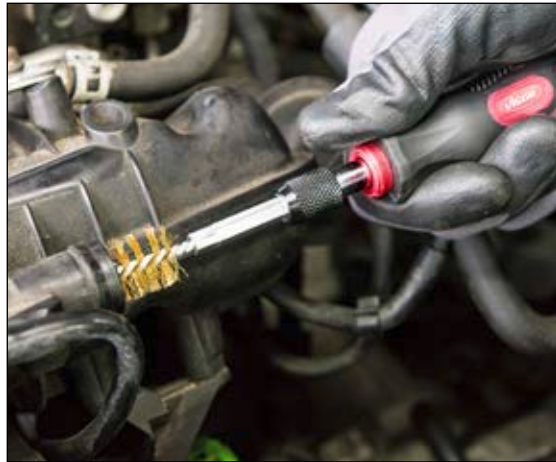

**38**

**61,80 €**  
zzgl. MwSt.



Ersatzteile 10er Pack

**10**

VIGOR No.	Bezeichnung	EAN 4047728+	€
V4646M-8	Messingbürsten Satz Ø 8 mm	054102	17,35
V4646M-9	Messingbürsten Satz Ø 9 mm	054119	17,35
V4646M-10	Messingbürsten Satz Ø 10 mm	054126	17,35
V4646M-11	Messingbürsten Satz Ø 11 mm	054133	17,35
V4646M-12	Messingbürsten Satz Ø 12 mm	054140	17,35
V4646M-13	Messingbürsten Satz Ø 13 mm	054157	17,35
V4646M-14	Messingbürsten Satz Ø 14 mm	054164	17,35
V4646M-15	Messingbürsten Satz Ø 15 mm	054171	19,25
V4646M-16	Messingbürsten Satz Ø 16 mm	054188	19,25
V4646M-17	Messingbürsten Satz Ø 17 mm	054195	19,25
V4646M-18	Messingbürsten Satz Ø 18 mm	054201	19,25
V4646M-19	Messingbürsten Satz Ø 19 mm	054218	19,25
V4646N-8	Nylonbürsten Satz Ø 8 mm	054225	15,50
V4646N-9	Nylonbürsten Satz Ø 9 mm	054232	15,50
V4646N-10	Nylonbürsten Satz Ø 10 mm	054249	15,50
V4646N-11	Nylonbürsten Satz Ø 11 mm	054256	15,50
V4646N-12	Nylonbürsten Satz Ø 12 mm	054263	15,50
V4646N-13	Nylonbürsten Satz Ø 13 mm	054270	15,50

VIGOR No.	Bezeichnung	EAN 4047728+	€
V4646N-14	Nylonbürsten Satz Ø 14 mm	054287	15,50
V4646N-15	Nylonbürsten Satz Ø 15 mm	054294	15,50
V4646N-16	Nylonbürsten Satz Ø 16 mm	054300	15,50
V4646N-17	Nylonbürsten Satz Ø 17 mm	054317	15,50
V4646N-18	Nylonbürsten Satz Ø 18 mm	054324	15,50
V4646N-19	Nylonbürsten Satz Ø 19 mm	054331	15,50
V4646S-8	Stahlbürsten Satz Ø 8 mm	053587	15,50
V4646S-9	Stahlbürsten Satz Ø 9 mm	053594	15,50
V4646S-10	Stahlbürsten Satz Ø 10 mm	053600	15,50
V4646S-11	Stahlbürsten Satz Ø 11 mm	054010	15,50
V4646S-12	Stahlbürsten Satz Ø 12 mm	054027	15,50
V4646S-13	Stahlbürsten Satz Ø 13 mm	054034	15,50
V4646S-14	Stahlbürsten Satz Ø 14 mm	054041	15,50
V4646S-15	Stahlbürsten Satz Ø 15 mm	054058	17,35
V4646S-16	Stahlbürsten Satz Ø 16 mm	054065	17,35
V4646S-17	Stahlbürsten Satz Ø 17 mm	054072	17,35
V4646S-18	Stahlbürsten Satz Ø 18 mm	054089	17,35
V4646S-19	Stahlbürsten Satz Ø 19 mm	054096	17,35



## Fächerscheiben Satz 115 mm

- Starke Abtragsleistung und müheloser Flächenschliff auf Stahl und Edelstahl ohne zu schmieren. Hinterlässt keine Kratzer auf dem Werkstück
- Universal Fächerscheibe mit hoher Standzeit
- Inhalt: 10 Stück



VIGOR No.	XX	Außen Ø mm	Aufnahme mm	Körnung	1/min	EAN 4047728+	€
V6810-115K40	10	115	22.23	40	13280	067737	29,90
V6810-115K60	10	115	22.23	60	13280	067744	29,90
V6810-115K80	10	115	22.23	80	13280	067751	29,90

## Fächerscheiben Satz 125 mm

- Starke Abtragsleistung und müheloser Flächenschliff auf Stahl und Edelstahl ohne zu schmieren. Hinterlässt keine Kratzer auf dem Werkstück
- Universal Fächerscheibe mit hoher Standzeit
- Inhalt: 10 Stück



VIGOR No.	XX	Außen Ø mm	Aufnahme mm	Körnung	1/min	EAN 4047728+	€
V6810-125K60	10	125	22.23	60	12200	067775	31,10
V7010-125K80	10	125	22.23	80	12200	070690	31,10

## Trennscheiben Satz

- Freihand-Trennscheiben zur Bearbeitung von Edelstahl und Stahl u.a. für dünne Bleche (z.B. Karosserie), Stahlseile, Profile, Rohre, NE-Metallen und hochwarmfesten Materialien
- Besonders schnittige Scheibe mit guter Standzeit

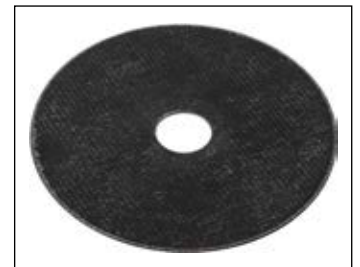

VIGOR No.	XX	Außen Ø mm	Aufnahme mm	Stärke mm	1/min	EAN 4047728+	€
V6811-115	10	115	22.23	1	13280	067287	12,25

## Außen-Entgrater

- Entgraten von Schrauben, Gewinden sowie Anpassen von deformierten Antriebswellen, Spurstangen und Stehbolzen an der Radnabe
- 6,3 mm Sechskant Antrieb
- Drehzahl: 0 – 500 U/Min
- Schneidplättchen aus hochfestem Wolframstahl gefertigt
- Geeignet für folgende Materialien:
  - Edelstahl
  - Stahl
  - Messing
  - NE-Metalle
  - Kunststoffe

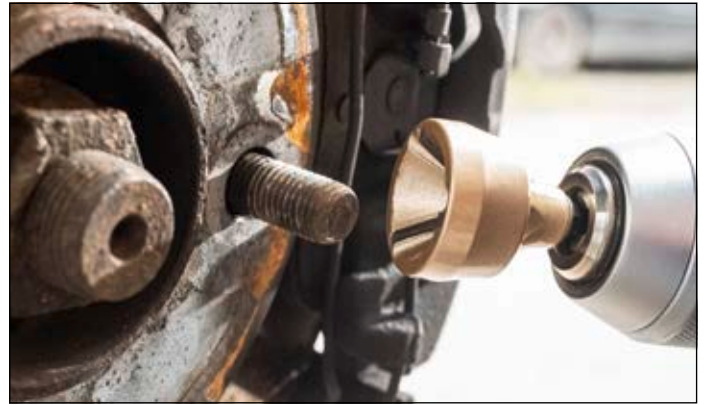
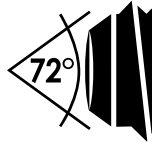

V7402



V7403



VIGOR No.	∅ mm	EAN 4047728+	€
V7402	3–19	074025	54,35
V7403	13–35	074032	93,85

## V4638, EAN 4047728046381

### Sicherheits-Laufbühne · Aluminium

- Leicht zu tragen
- Sicherheitsverriegelung an beiden Füßen
- Maximale Tragkraft: 150 kg
- Gewicht: 7,2 kg



Platzsparend  
zusammenklappbar

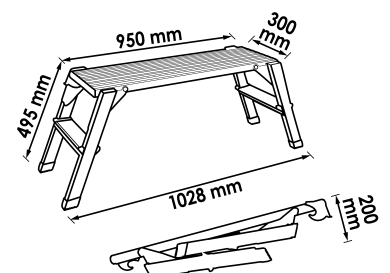

**164,50 €**  
zzgl. MwSt.





**V5679M**, EAN 4047728080637

### Magnet-Button Satz

- Befestigung von beispielsweise Auftragszetteln, Notizen und Erinnerungen an metallischen Oberflächen
- Satz bestehend aus 3 Stück
- Haltekraft: 3 kg



**NEU**



**21,20 €**  
zzgl. MwSt.

**V5680**, EAN 4047728081436

### Magnethalter

- Universelles Befestigen von Gegenständen und Equipment, z.B.: Druckluftschläuche, Kabel, Gehörschutz, kabelgebundene Werkzeuge
- Gummierter Magnet zum Schonen der Oberfläche
- Haltekraft: 18 kg

**NEU**



**28,- €**  
zzgl. MwSt.

**V5531**, EAN 4047728055314

### Einhand Mini-Saugheber

- Zum Heben, Tragen und Halten
- Justieren und Einsetzen von Spiegelgläsern
- Einhandbedienung durch Hebel
- Tragkraft maximal: 8 kg

Mit Löseknopf

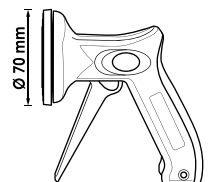

**21,60 €**  
zzgl. MwSt.



## Diagnose / Batterie / Elektrik

Video-Endoskop	252
Rauchgas-Leckagetester	253
Elektrik	254 256-257
Multimeter	254
Kabelentriegelung	255
Crimpzangen Satz	256



V7501/2, EAN 4047728080255

## Video-Endoskop

- Analyse und Dokumentation von Schadensbildern an schwer zugänglichen Stellen
- Sonde: Ø 4,9 mm
- Sondenlänge: 1000 mm
- Kamera-Auflösung: 1280x720 Pixel
- Kamera Blickwinkel: 80°
- 6 dimmbare LED
- Tiefenschärfe: 20 – 80 mm
- 5 Zoll Display, schwenkbar
- Bildschirmauflösung: 1280x720 Pixel
- 6 Ah, 3,7 V Li-Ionen Akku
- Netzteil 2 A · 5 V, USB-Ladekabel und 32 GB TF-Speicherkarte im Lieferumfang enthalten

**NEU**



**1280 x 720 Pixel**



**800,- €**  
zzgl. MwSt.



# Rauchgas-Leckagetester



V7524, EAN 4047728081320

## Rauchgas-Leckagetester

- Leckage-Suche in geschlossenen Systemen
- Durch Applikation von Rauchgas werden Undichtigkeiten schnell visualisiert
- Betrieb über das 12 V Bordnetz
- Druckbeaufschlagung mittels „Luft“-Modus und integriertem Manometer ohne weitere Hilfsmittel möglich
- Rauchgaserzeugung mit geeignetem Hilfsmittel (Pflanzliches Glycerin oder Baby-Pflegeöl)
- Universelle Anwendungsmöglichkeiten durch verschiedene Adapter
- Eingebauter Luftkompressor
- Automatische Sicherheitsabschaltung bei drohender Überhitzung
- Stufenlos einstellbarer Luftdurchfluss
- Vielfältige Anwendungsmöglichkeiten, zum Beispiel:
  - Ansaug- und Ladedrucksystem
  - Kurbelgehäuse
  - Abgas- und Abgasrückführungssystem
  - Kraftstoffsystem
  - Adblue- und Additivsystem
  - Reifen
  - Klimaanlage
  - EVAP-Kraftstoffsystem (US-Fahrzeuge)
  - Karosserie und Verglasung
  - (Windgeräusche, Feuchtigkeitseintritt etc.)

**NEU**



**599,- €**  
zzgl. MwSt.

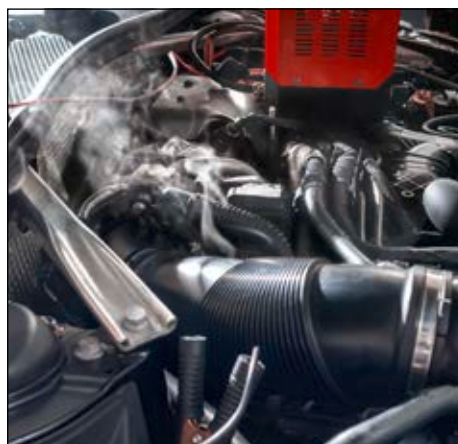

**V4324**, EAN 4047728**043243**

## Digital Multimeter

- Kompakt und handlich
- Kontrastreiche, einzeilige LCD-Anzeige inklusive Hintergrundbeleuchtung
- 19-stelliger Drehschalter
- Zuverlässige Warnung durch automatische Überlauf- und Polaritätsanzeige zur möglichen Fehlervermeidung
- Aufstellbar inklusive Gummi-Schutzhülle
- Messkabel mit Berührungsschutz
- DC: 200 mV – 600 V
- AC: 200 V – 600 V
- DC: 200 mA – 10 A
- Widerstand: 200 – 2000 Ohm
- Dioden-Tester
- Maximale Anzeige: 1999
- 9 V Batterie (im Gerät)
- Sicherungen:
  - 1 x 250 mA / 250 V
  - 1 x 10 A / 250 V
- Multimeter zur Ruhestromprüfung
- Verwendung mit Messkabel Satz V4326
- Funktionen:
  - Gleich- und Wechselspannung-Messungen
  - Gleich- und Wechselstrom-Messung
  - Widerstandsmessung
  - Diodenprüfung (mit akustischem Signal)
  - Durchgangsprüfung (mit akustischem Signal)
  - Data Hold Funktion



VIGOR No.	Bezeichnung	EAN 4047728+	€
V4324-1	Sicherungen · 5 Stück	053532	4,45
V4324-2	Messkabel für V4324	053549	6,55

**36,10 €**  
zzgl. MwSt.

**V1722**, EAN 4047728**017220**

## Autolichtprüfer

∠ 6 – 24 V

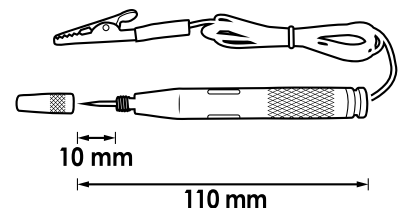
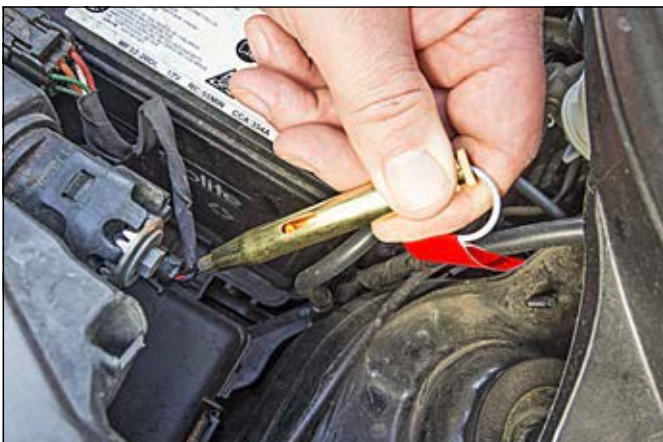

**9,20 €**  
zzgl. MwSt.



# Kabelentriegelung



**V4451**, EAN 4047728**044516**

## Kabelentriegelungs-Werkzeug Satz

- Beschädigungsfreies Entriegeln von elektrischen Steckern und Verbindern z.B. bei ABS, Klimasensoren, Radio, PDC, Anhängerkupplungs-Modul etc.
- Schnelle Fehlersuche durch Korrosions- oder Verbindungsdefekte
- Für Rund- und Flachsteckkontakte



**Unentbehrlich für Mechatroniker  
und Kfz-Elektriker**

VIGOR No.	Bezeichnung	Ausführung	EAN 4047728+	€
V4451-1	Einzelner Kabelentriegeler 1 · BMW · MERCEDES-BENZ · OPEL · VW/AUDI		053693	14,80
V4451-2	Einzelner Kabelentriegeler 2 · BMW · JAGUAR · MERCEDES-BENZ · PORSCHE · SAAB · SEAT · ŠKODA		053709	14,80
V4451-3	Einzelner Kabelentriegeler 3 · BMW · MERCEDES-BENZ · OPEL · PORSCHE · VW/AUDI		053716	14,80
V4451-4	Einzelner Kabelentriegeler 4 · FORD		053723	10,60
V4451-5	Einzelner Kabelentriegeler 5 · BMW · FORD · MERCEDES-BENZ · OPEL · PORSCHE · SEAT · ŠKODA · VW/AUDI		053730	10,60
V4451-6	Einzelner Kabelentriegeler 6 · BMW · FORD · JAGUAR · OPEL · MERCEDES-BENZ · PORSCHE · SAAB · SEAT · ŠKODA · VW/AUDI		053747	10,60
V4451-7	Einzelner Kabelentriegeler 7 · MERCEDES-BENZ		053754	10,60
V4451-8	Einzelner Kabelentriegeler 8 · FORD · JAGUAR · MERCEDES-BENZ · OPEL · PORSCHE · VW/AUDI		053761	10,60
V4451-9	Einzelner Kabelentriegeler 9 · FORD · MERCEDES-BENZ		053815	10,60
V4451-10	Einzelner Kabelentriegeler 10 · MERCEDES-BENZ		053822	10,60
V4451-11	Einzelner Kabelentriegeler 11 · BMW · FORD · JAGUAR · MERCEDES-BENZ · OPEL · PORSCHE · SAAB · SEAT · ŠKODA · VW/AUDI		053839	10,60
V4451-12	Einzelner Kabelentriegeler 12 · OPEL · RENAULT · ŠKODA · VW/AUDI		053846	10,60
V4451-13	Einzelner Kabelentriegeler 13 · FORD · MERCEDES-BENZ		053853	10,60
V4451-14	Einzelner Kabelentriegeler 14 · FORD · JAGUAR · PORSCHE		053860	10,60
V4451-15	Einzelner Kabelentriegeler 15 · BMW · FORD · MERCEDES-BENZ · OPEL · SEAT · ŠKODA · VW/AUDI		053877	10,60
V4451-16	Einzelner Kabelentriegeler 16 · BMW · FORD · JAGUAR · MERCEDES-BENZ · OPEL · PORSCHE · VW/AUDI		053884	10,60
V4451-17	Einzelner Kabelentriegeler 17 · BMW		053891	10,60
V4451-18	Einzelner Kabelentriegeler 18 · MERCEDES-BENZ		053907	10,60
V4451-19	Einzelner Kabelentriegeler 19 · CITROËN · FIAT CHRYSLER · FORD · HONDA · MAZDA · OPEL · MERCEDES-BENZ · MITSUBISHI · PORSCHE · RENAULT · SEAT · TOYOTA · VW/AUDI		053914	10,60
V4451-20	Einzelner Kabelentriegeler 20 · FORD		053921	10,60
V4451-21	Einzelner Kabelentriegeler 21 · BMW · FORD · JAGUAR · MERCEDES-BENZ · OPEL · PORSCHE · SAAB · SEAT · ŠKODA · VW/AUDI		053938	10,60
V4451-22	Einzelner Kabelentriegeler 22 · HONDA · OPEL · TOYOTA · VW/AUDI		053945	10,60
V4451-23	Einzelner Kabelentriegeler 23 · OPEL · VW/AUDI		053952	10,60



**232,- €**  
zzgl. MwSt.



**V2499**, EAN 4047728024990

## Crimpzangen Satz

- Fünf austauschbare Crimp-Einsätze:
- Crimp-Einsatz A: für isolierte Kabelschuhe 0,5 – 6,0 mm<sup>2</sup> (rot, blau, gelb)
- Crimp-Einsatz B: für geschlossene, unisolierte Kabelschuhe 1,5 · 2,5 · 6,0 · 10 mm<sup>2</sup>
- Crimp-Einsatz C: für offene, unisolierte Kabelschuhe 0,5 – 6,0 mm<sup>2</sup> (Breite bis 6,3 mm)
- Crimp-Einsatz D für Ader-Endhülsen mit und ohne Kragen 0,5 – 4,0 mm<sup>2</sup>
- Crimp-Einsatz F: für Ader-Endhülsen über 6,0 mm<sup>2</sup>



**159,50 €**  
zzgl. MwSt.

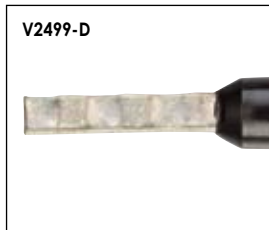
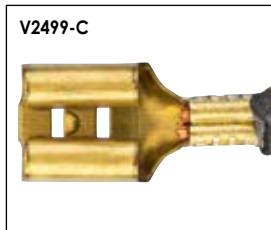

## Ersatzteile

VIGOR No.	Bezeichnung	Ausführung	EAN 4047728+	€
V2499-A	Crimp-Einsatz A: für isolierte Kabelschuhe von 0,5 – 6,0 mm <sup>2</sup> (rot · blau · gelb)		053440	31,20
V2499-B	Crimp-Einsatz B: für geschlossene · unisolierte Kabelschuhe von 1,5 · 2,5 · 6,0 · 10 mm <sup>2</sup>		053457	31,20
V2499-C	Crimp-Einsatz C: für offene · unisolierte Kabelschuhe von 0,5 – 6,0 mm <sup>2</sup> (Breite bis 6,3 mm)		053464	31,20
V2499-D	Crimp-Einsatz D: für Aderendhülsen mit und ohne Kragen von 0,5 – 4,0 mm <sup>2</sup>		053471	31,20
V2499-F	Crimp-Einsatz F: für Aderendhülsen über 6,0 mm <sup>2</sup>		053488	31,20

**V2499-A**, EAN 4047728053440

## Crimp Einsatzbacken



**31,20 €**  
zzgl. MwSt.

**V7548**, EAN 4047728075480

## Batterie-Tester

- Prüfung des Status von Batterie und Ladesystemen (12- und 24 V)
- Geeignet für Start-Stopp Batterien
- Für Pkw, Motorräder, Transporter und Boote
- Funktionen:
  - Statusbericht von Batterie und Ladesystemen
  - Belastungsanzeige beim Startvorgang des Motors
  - Identifizierung von defekten Batterien
  - Optionaler Druck der Testergebnisse
- Mobiler Einsatz, ohne Stromzufuhr
- Ermöglicht die Prüfung im ein- und ausgebauten Zustand
- Benutzerfreundliche Bedienung
- Verpolungsschutz verhindert Kurzschluss
- Thermopapier-Rolle im Lieferumfang enthalten
- Klemmkabel-Länge: 600 mm



**238,- €**  
zzgl. MwSt.

**V7548-1**, EAN 4047728075527

## Thermopapier-Rolle

- Breite: 56 mm
- Lauflänge: 5 m
- Durchmesser: 29 mm
- Hülsendurchmesser: 15 mm



**8,35 €**  
zzgl. MwSt.

**V4326N**, EAN 4047728079860

## Messkabel Satz

- Kfz-Bedarf und 12 V Batterien
- Messleitung-Adapter zur Vereinfachung der Fehlersuche direkt am Fahrzeug
- Polaritätsprüfer zur Prüfung von Hallgeber und Photosensoren
- Mess-Potentiometer zur Prüfung des Temperaturfühlers und Tankgebers
- Verwendung mit Multimeter V4324
- Je 3 Flachstecker, Flachsteckhülsen, Rundstecker, Stiftkabelstecker und Stiftkabelhülsen



**NEU**

**233,- €**  
zzgl. MwSt.



## Motor / Kühlung / Klima

Motor-Werkzeuge

259–262

Kühlsystem-Diagnose

263–265

Turbosystem-Diagnose

266–267

Kompressions- und Druckverlusttester

268

Vakuum- und Druckpumpen Satz

269

Injektorschacht Reinigung

270



**V5676**, EAN 4047728**056762**

## Lambdasonden Satz

- Lambdasonden, Einspritzdüsen sowie Thermoventile in schwer zugänglichen Bereichen

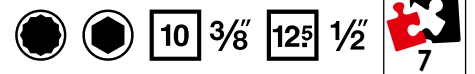

**92,- €**  
zzgl. MwSt.

● 22 mm

10 3/8



80  
L  
mm

● 22 mm

10 3/8



90  
L  
mm

● 27 mm

10 3/8



74  
L  
mm

● 22 mm

125 1/2



● 29 mm

125 1/2



90  
L  
mm

○ 27 mm

125 1/2



83  
L  
mm

● 22 mm

10 3/8



**V7002/4**, EAN 4047728079815

## Zündkerzen Steckschlüssel Satz

- Kugelgelenke ermöglichen leichten Ein- und Ausbau an schwer zugänglichen Stellen z.B. bei Motorrädern oder BMW N43- und N53-Motoren
- Magnetisch
- Schlanke Bauform
- Größen: SW 14 · 16 · 18 · 20,8 mm
- Für Handbetätigung

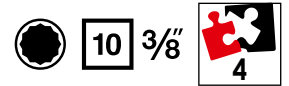

**NEU**

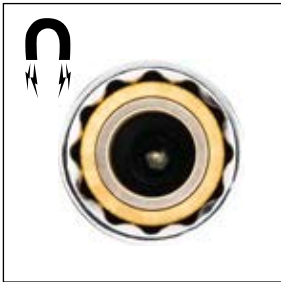

VIGOR No.	Bezeichnung	Ausführung	■	SW	EAN 4047728+	€
V7002-14	Zündkerzen-Einsatz		10 3/8	14 mm	079822	18,-
V7002-16	Zündkerzen-Einsatz		10 3/8	16 mm	079839	20,-
V7002-18	Zündkerzen-Einsatz		10 3/8	18 mm	079846	22,-
V7002-20.8	Zündkerzen-Einsatz		10 3/8	20.8 mm	079853	24,-

**69,- €**  
zzgl. MwSt.



**V6741**, EAN 4047728**067416**

## Abzieher Satz für Zündspulen

- Professionelles und beschädigungsfreies Demontieren von Zündspulen und Zündspulen-Leisten an VAG und OPEL- Motoren
- Aufstecken und anschließendes Abziehen ermöglicht gleichmäßiges Demontieren des Zündmoduls
- Paarweise Verwendung empfohlen
- Größte Marktdeckung
- 2 Zündmodul-Abzieher für:
  - CHEVROLET/GMC Aveo Cruze · OPEL/VAUXHALL Adam · Agila B · Astra J · Cascada Combo · Corsa D · Meriva B · Mokka · Zafira Tourer
  - Motoren:
    - 1 Liter A10XEP (LDB), 1,2: A12XEL (LWD) A12XER (LDC), 1,4: A14XEL (L2Z) A14XER (LDD) LDU
    - 1,4 Liter (T) A14NEL (LUH) A14NET (LUJ) Twinport / ecoFLEX Motoren
  - OPEL 3- bzw. 4-Zylinder Benzin-Einspritzmotoren z.B. bei Agila A · Astra F · Astra G · Astra H · Astra J · Calibra Combo · Corsa B · Corsa C · Corsa D · Frontera A · Frontera B · Insignia · Meriva A · Meriva B · Omega B · Signum · Tigra A · Tigra B · Vectra B · Vectra C · Zafira A · Zafira B
  - Motorcodes: 20LEH · 2HO · A10XEP · A14NEL · A14NET · A14XER · A16LET · A16XER · A18XER · C22SEL · LDD · LDE · LLU · LUH · LUJ · X14NZ · X14SZ · X14XE · X16SZR · X16XE · X16XEL · X18XE · X20SE · X20XEV · X22SE · X22XE · Y22SE · Z10XEP · Z12XE · Z12XEP · Z14XE · Z14XEL · Z14XEP · Z16LEL · Z16LER · Z16LET · Z16XE · Z16XER · Z16YNG · Z18XE · Z18XER · Z20LER
  - 4 Zündklaven:
    - TYP A (26 mm): z.B. VW Golf · Bora · Beetle · Lupo · Passat · Touran · T4 · AUDI A2
    - TYP B (18 mm): Bora · Golf · Passat · Sharan · Touareg · Phaeton · T5
    - TYP C (43 mm): 8 und 12 Zylinder Motoren wie Phaeton u.a.
    - TYP D (35 mm): Direkteinspritzer VW Golf · Touran · Passat und Eos sowie AUDI A4 und A6



**76,85 €**  
zzgl. MwSt.

**V6740**, EAN 4047728**077774**

## Abzieher Satz für Zündspulen · VAG

- Sicheres und beschädigungsfreies Entfernen von Zündspulen mit Leistungsstufe gemäß Herstellervorgabe, z.B. an 1,0 l · 1,0 l TSI · TFSI · TGI · GTI · CNG · 1,2 l TSI · 1,4 l 25 · 30 · 35 · 40 · 45 TSI · TFSI · TGI · CNG · GTE · Mild Hybrid · e-Hybrid · 1,6 l · 1,6 l SRE · MPI 2,0 l GTI
- Motoren u.a. verbaut in folgenden Modellen: AUDI A1 · A3 · A4 · A5 · Q2 · Q3 SEAT Alhambra · Arona · Ateca · Cupra Formentor · Ibiza · León · Mii · Tarraco · Toledo ŠKODA Citigo · Fabia · Kamiq · Karoq · Kodiaq · Octavia · Rapid · Scala · Super · Yeti VW Arteon · Beetle · Caddy · Golf 6-8 · Jetta 4-7 · CC · Passat B8 · Polo 5-6 · Scirocco · Sharan · T7 · Taigo · Tiguan · Touran · T-Cross · T-Roc · Up!
- Demontage von beiden Zündspulenversionen möglich: → 04C.905.110.J Bj. →2017 → 04E.905.110.K Bj. 2017→

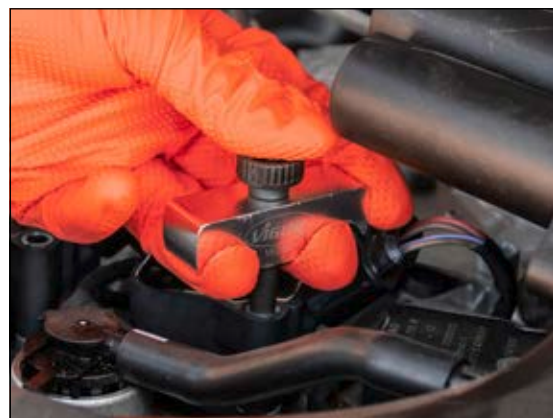

**39,90 €**  
zzgl. MwSt.



**V3381**, EAN 4047728033817

## Schlauchschellen Satz

- Für Schläuche mit Ø bis 45 mm



**32,40 €**  
zzgl. MwSt.

**V3571**, EAN 4047728035712

## Keilrippenriemen Werkzeug

- Glasfaserverstärktes Nylon
- Einfachste Handhabung auf dem Markt
- Keine Anpassung notwendig
- Für alle elastischen Riemenarten:  
Klimaanlagen, Lichtmaschinen sowie einfache und doppelte Riemenscheiben



Montage



Demontage



**48,35 €**  
zzgl. MwSt.



**V5660**, EAN 4047728056601

**Kupplung 4,4 mm auf 7,2 mm**

- Adaptierung Handpumpe V3729 auf Fremdfabrikate, z.B. Klann Adapter / Systeme (4,4 mm auf 7,2 mm)



**24,70 €**  
zzgl. MwSt.

**V5922**, EAN 4047728059220

**Kupplung 7,2 mm auf 4,4 mm**

- Adaptierung VIGOR Kühlsystem Adapter auf z.B. Klann Handpumpen / Systeme (7,2 mm auf 4,4 mm)



**24,70 €**  
zzgl. MwSt.

**V2459N**, EAN 4047728075541

**Refraktometer**

- Schnelle, präzise Kontrolle des Frostschutzgehaltes an Kühl- und Scheibenwaschflüssigkeit sowie zur Prüfung der Batteriesäuredichte und AdBlue
- Einstellbares Okular mit Gummi-Augenaufgabe
- Linke Skala: Batteriesäuredichte Messbereich 1100 – 1400 sg / Auflösung 0,01 sg
- Mittlere Skala: Frostschutz auf Basis Propylenglykol G 13 Messbereich 0° C bis -50° C / Auflösung 5° C sowie Frostschutz auf Basis Ethylenglykol G 11 / G 12 Messbereich 0° C bis -50° C / Auflösung 5° C
- Rechte Skala oben: AdBlue (VRA) Harnstoffgehalt Messbereich 30% – 35% / Auflösung 0,1%
- Rechte Skala unten: Frostschutz Scheibenwaschflüssigkeit SRF 1 Messbereich 10° C bis -40° C / Auflösung 1° C
- Kunststoffbox mit Weichschaum-Einlage
- Inhalt:
  - 1 x Refraktometer
  - 1 x Pipette



**Anwendbar u.a. für Kühl- und Scheibenwasser, Batteriesäure und AdBlue**

**71,30 €**  
zzgl. MwSt.



**V1963/28**, EAN 4047728081467

## Kühlsystem-Diagnose Satz

- Pkw Diagnose
- Neue Adapter Serie mit ca. 20% Platzersparnis pro Adapter
- VIGOR Kühlsystem-Deckel bauen ca. 20% weniger an Höhe auf als auf dem Markt vergleichbare Produkte
- Komfortables und effizientes Arbeiten, durch das Erreichen von nahezu allen Ausgleichsbehältern
- Größte Marktabdeckung
- Inklusive Adapter Nr. 23 für gängige Fahrzeugmodelle wie AUDI A3 · A4 · VW Golf · Passat · Polo
- Kompletter Satz für Servicearbeiten am Kühlsystem und am Heizkreislauf
- Umfangreiche Adapterauswahl für Fahrzeuge mit wassergekühlten Motoren
- 3 Funktionen: Kühler abdrücken (Kontrolle auf Undichtigkeiten) · befüllen · reinigen
- Druckverlustkontrolle über Manometer
- Befüllen erzeugt Vakuum im Kühlkreislauf (Vorteil: Blasenfreies Einsaugen der Flüssigkeit)
- Problemlose Befüllung auch größerer Motoren ohne thermische Schwachpunkte
- Füllsystem universell adaptierbar durch konischen Gummianschluss-Stutzen
- Messbereich: 0 – 2,5 bar



VIGOR No.	Bezeichnung	Ausführung	EAN 4047728+	€
V1963N-6	Kühlsystem Diagnose Adapter		082044	22,50
V1963N-8	Kühlsystem Diagnose Adapter		082051	22,50
V1963N-9	Kühlsystem Diagnose Adapter		082068	22,50
V1963N-A	Kühlsystem Diagnose Adapter		082082	22,50
V1963N-B	Kühlsystem Diagnose Adapter		082136	22,50
V1963N-C	Kühlsystem Diagnose Adapter		082099	22,50
V1963N-E	Kühlsystem Diagnose Adapter		082129	22,50
V1963N-F	Kühlsystem Diagnose Adapter		082112	22,50
V1963N-G	Kühlsystem Diagnose Adapter		082167	22,50
V1963N-H	Kühlsystem Diagnose Adapter M32x2,0		082181	22,50
V1963N-M	Kühlsystem Diagnose Adapter		082105	22,50
V1963N-R	Kühlsystem Diagnose Adapter		082174	22,50



**NEU**

28

**399,- €**  
zzgl. MwSt.

**Größte Modellabdeckung  
auf dem Markt!**  
**Kompatibel mit Hybridfahrzeugen**

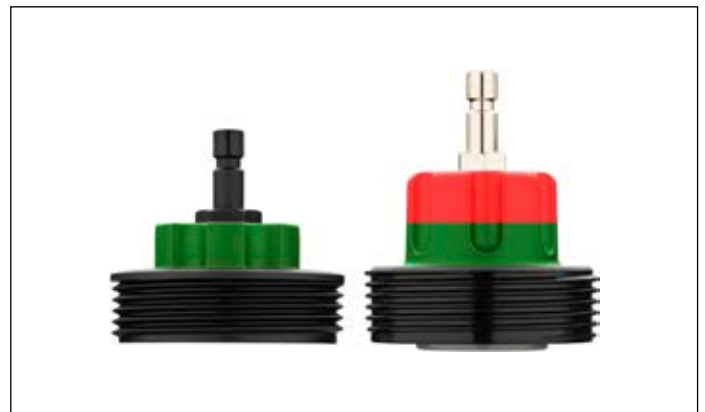

VIGOR No.	Bezeichnung	Ausführung	EAN 4047728+	€
V1963N-S	Kühlsystem Diagnose Adapter		082143	22,50
V1963N-T	Kühlsystem Diagnose Adapter		082150	22,50
V1963N-X	Kühlsystem Diagnose Adapter M55x2,5		082198	22,50
V1963-3	Prüfadapter schwarz R123 · R124		053242	16,80
V1963-4	Prüfadapter blau R123 · R125		053259	23,90
V1963-5	Bajonett Adapter · Ø 38 mm		053266	27,60
V1963-6	Bajonett Adapter · Ø 42 mm		053273	27,60
V1963-7	Bajonett Adapter · Ø 50 mm		053280	27,60
V3729	Handpumpe mit Manometer		037297	102,50
V4202	Vakuum-Befüllereinheit		042024	107,50
V1963-22	Thermometer		053433	20,40
V1963-25	Universaladapter / Konus		060127	16,80



**V4192**, EAN 4047728041928

## Turbosystem-Abdrücker Satz für Klicksysteme

- Schnelle Diagnose der Ladeluft-Systeme in neuen Fahrzeuggenerationen, bei denen Luffrohre mit Klicksystem verbunden werden
- Durchführung der Dichtheitsprüfung anhand von Geräuschenwicklung, Lecksuchspray oder Druckabfall
- Inhalt: 6 Stopfen-Paare 31 · 38 · 46 · 51 · 56 · 61 mm



Ohne Manometer

*Ermöglicht zeitsparende und fachgerechte Ermittlung von undichten Ladeluftschläuchen*



**239,- €**  
zzgl. MwSt.

**V4233**, EAN 4047728042338

## Manometer für Turbosystem-Abdrücker Satz

Für V3595 · V4192 und V4331



**61,70 €**  
zzgl. MwSt.



**V4461**, EAN 4047728044615

## Kompressions- und Druckverlusttester Satz

- Professionelle Prüfung von Kompression oder Druckverlust für die meisten Pkw-, Lkw-, Motorrad-, Bus-, Agrar- und Boots- Motoren sowie Hdi- TDCI- und Pumpe-Düse- Motoren
- Für Diesel- und Benzinmotoren
- Enthält Glühkerzenadapter für z.B.: ALFA ROMEO · BMW · CHRYSLER · DAEWOO · FIAT · FORD · HYUNDAI · ISUZU · LANDROVER · MAZDA · MERCEDES-BENZ · MITSUBISHI · NISSAN · OPEL · PSA · RENAULT · SAAB · SUZUKI · TOYOTA · VAG · VAUXHALL · Volvo · etc.
- Zündkerzenadapter M 10 · M 12 · M 14 · M 18
- Kompressions-Druckprüfer maximal 50 bar
- Schnellkupplungen in gerader und abgewinkelter Ausführung
- Einspritzdüsen Adapter M 20 · M 22 · M 24 sowie für FORD Stanadyne Injektoren

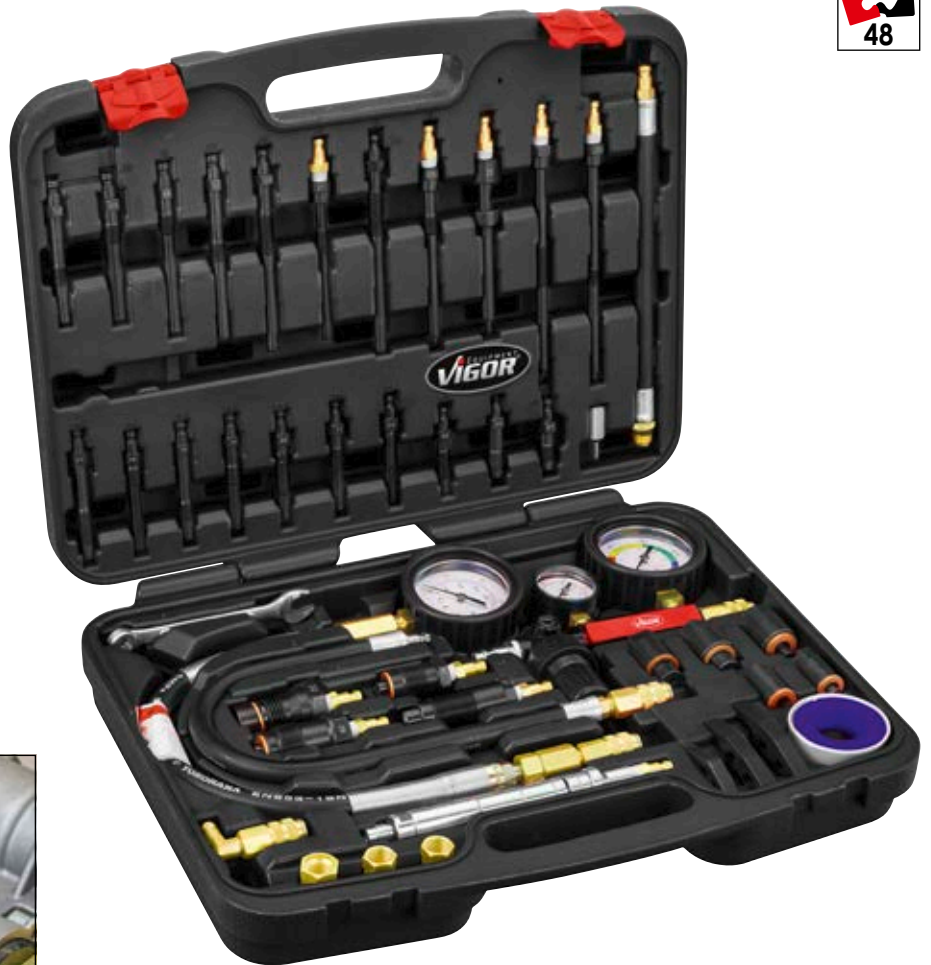

*Für Diesel- und Benzinmotoren*

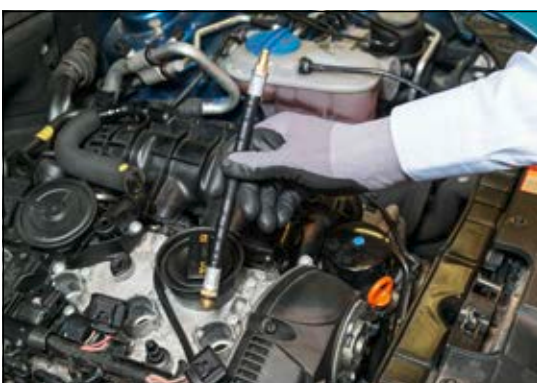

**804,- €**  
zzgl. MwSt.

# Vakuum- und Druckpumpen Satz



V4325, EAN 4047728043250

## Vakuum- und Druckpumpen Satz

- Überprüfen von Druck- und Unterdrucksystemen
- Ladedruck
- Unterdruck-Magnetventilen
- MAP-Sensoren
- Tankbelüftungen
- Bremsleitungs-Systeme
- Inklusive umfangreichem Adapter Sortiment



**204,- €**  
zzgl. MwSt.

**Auch geeignet für  
Bremsleitungs-Systeme**



Schlauchlänge: 630 mm



Füllmenge: 120 ml



Robuste  
Metallausführung

Anzeigebereich: -1 bis 4 bar  
Unterdruckanzeige-Bereich: von -1 bis 0 bar

Maximaler Druck: bis 3 bar  
Maximaler Unterdruck: bis 0,7 bar



**V4941N**, EAN 4047728077293

## Injektorschacht Reinigungs Satz

- Beseitigung von Rußrückständen, Partikeln an HDi-, Diesel-Direkteinspritzung und Common-Rail Motoren mit Bosch- und Delphi-Injektoren
- Inklusive Verschlussstopfen gegen Brennraum-Verunreinigungen
- Zentrierkronen zur genauen Führung



**266,- €**  
zzgl. MwSt.



**Fachgerechtes Reinigen des Injektorschachtes, der Injektorspitze und Düsenzapfenöffnung**

VIGOR No.	Bezeichnung	Ausführung	L mm	EAN 4047728+	€
V4941N-1	Dichtring-Spreizer		265	077415	59,90
V4941N-2	Reibahle		225	077422	24,90
V4941N-3	Fräserkopfhalter · lang · Rändelgriff		255	077439	39,90
V4941N-4	Adapter · flexibel		225	077446	19,90
V4941N-5	Fräserkopfhalter kurz		175	077453	19,90
V4941N-M5	Schutzkappe · M5		15	077460	7,-
V4941N-BL	Reinigungsbürste · lang		300	077576	9,90
V4941N-BK	Reinigungsbürste · kurz		85	077569	9,90
V4941N-19T	Sechskant · T-Griff · 19 mm		155	077521	19,90
V4941N-10	Halter für Schutzkappe · M5		200	077477	9,90
V4941N-11	Halter für Reinigungsbürste		90	077514	19,90
V4941N-245	Adapter · Ø 24,5 mm		32,8	077552	7,-
V4941N-20	Adapter · Ø 20 mm		32	077538	7,-
V4941N-22	Adapter · Ø 22 mm		32,8	077545	7,-

VIGOR No.	Bezeichnung	Ausführung	L mm	EAN 4047728+	€
V4941N-R1	Fräser · 120 Grad · 15,5x15,5 mm		38	077583	19,90
V4941N-R2	Fräser · 90 Grad · 15,5x15,5 mm		38	077590	19,90
V4941N-R3	Fräser · 90 Grad · 14x14 mm		38	077606	19,90
V4941N-R4	Fräser · 90 Grad · 19x21,5 mm Sechskant		38	077613	19,90
V4941N-R5	Fräser · 120 Grad · 17x21 mm		38	077620	19,90
V4941N-R6	Fräser · 90 Grad · 17x20 mm		38	077637	19,90
V4941N-R7	Fräser · 120 Grad · 17,5x20,5 mm		38	077644	19,90
V4941N-R8	Fräser · 90 Grad · 17x19,5 mm		38	077651	19,90
V4941N-R9	Fräser · 90 Grad · 17x19 mm		38	077668	19,90
V4941N-R10	Fräser · 90 Grad · 15x19 mm		38	077675	19,90
V4941N-R11	Fräser · 90 Grad · 17x17,5 mm		38	077682	19,90
V4941N-R12	Fräser · 120 Grad · 17x17 mm		38	077699	19,90
V4941N-R13	Fräser · 90 Grad · 17x17 mm		38	077705	19,90





## Öldienst



Öl-Messstäbe

272

Ölfilter-Spannschlüssel

273–274

Öl-Pumpen und Einfüllgeräte

275–276

**V5048**, EAN 4047728**050487**

## Tankgeberschlüssel · universal

- Betätigung Verschlussring Tankgeber
- Für beengte Platzverhältnisse

Fachgerechtes und  
zeitsparendes Arbeiten  
ohne Beschädigung  
des Verschlussringes

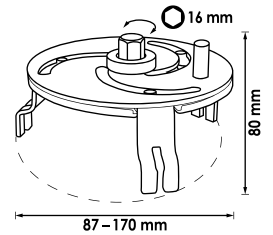

**95,85 €**  
zzgl. MwSt.

**V2112**, EAN 4047728**021128**

## Ölmesststäbe Satz MERCEDES-BENZ

- Messen des Motor- und Automatikgetriebe-Ölstandes
- Unverzichtbar nach Ölwechsel (Fahrzeugauslieferung werksseitig ohne Messstäbe, sondern nur mit Verschlussstopfen)

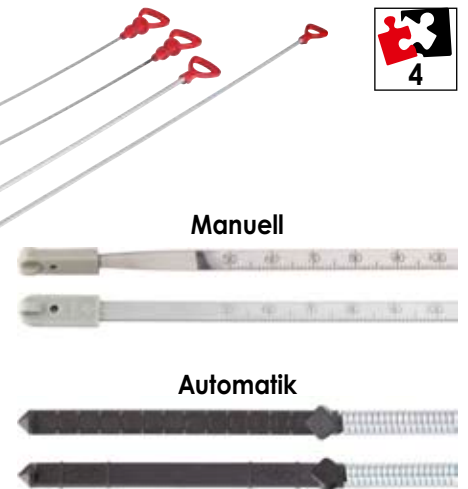
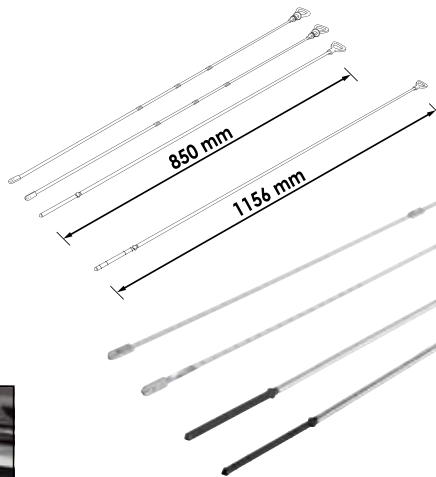

Manuell

Automatik



**155,- €**  
zzgl. MwSt.

**V2645**, EAN 4047728**026451**

## Ölmesststab AUDI

- Kontrolle des Füllstands nach Ölwechsel und anschließendem Vergleich mit Displayanzeige
- Für Modelle mit Ölstandsanzeige im Display (kein Peilstab am Motor)
- Hilfreich nach Tausch des Ölsensors oder Kalibrierung der Anzeige im Fahrerdisplay (vergleichbar T40178)
- Anwendung: u.a. für AUDI A4 / A5 / A6 mit Motoren 1,8 · 2,0 TFSI / 3,0 · 3,2 FSI / 2,0 · 2,7 · 3,0 TDI

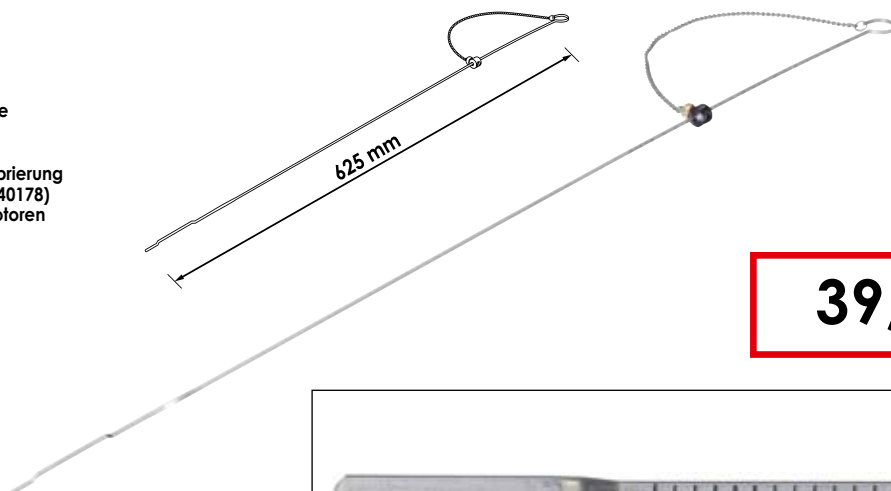

**39,60 €**  
zzgl. MwSt.



**V2511N**, EAN 4047728068239

## Ölfilter-Bandschlüssel

- Ein- und Ausbau von Ölfiltern
- Stufenlos verstellbar
- Einstellung auf Filter-Ø durch Drehen am Griffende
- Ergonomischer Handgriff

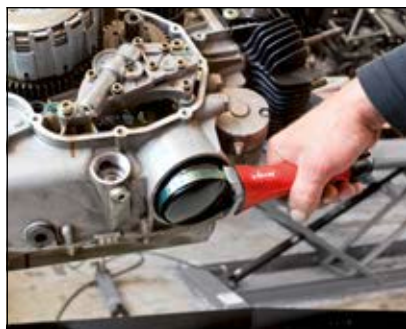

**23,20 €**  
zzgl. MwSt.

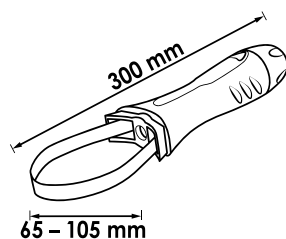

**V2521**, EAN 4047728025218

## Ersatz-Spannband

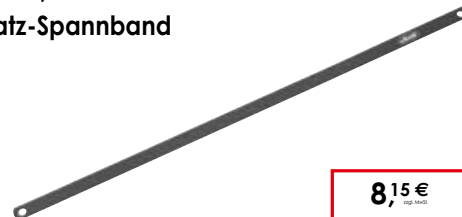

**8,15 €**  
zzgl. MwSt.

**V1281**, EAN 4047728012812

## Ölfilterkralle

- Antrieb wahlweise: 12 1/2 Innenvierkant oder SW 21 mm Außensechskant

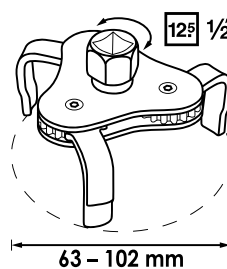
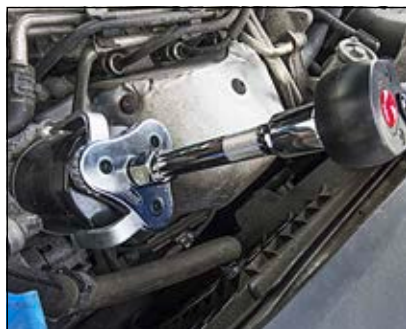

**31,35 €**  
zzgl. MwSt.



**V7385**, EAN 4047728077194

## Getriebe Werkzeug Satz · MERCEDES-BENZ · 9G-Tronic

- Ablassen und Befüllen des Getriebeöls an 9-Gang Tronic Automatikgetriebe mit Kennung 725 (725589029000 · 725589009000)
- Alle notwendigen Werkzeuge für den Ölwechsel
- Ablassschlüssel zum Einstellen des Steigrohres
- Inhalt:
  - Ölfilter-Adapter (Verwendung mit Öl Einfüllgerät V4385N)
  - Multifunktions-Ölablassschlüssel
  - Ölablassschrauben-Schlüssel



**39,90 €**  
zzgl. MwSt.

## Ölfilter-Spannschlüssel · universal

- Mechanische Arretierung des Ölfilterschlüssels vereinfacht das nachträgliche Ansetzen der Umschaltknarre an dem Ölfilterschlüssel
- Bei Rückbewegung der Umschaltknarre bleibt der Ölfilter-Spannschlüssel stets unter Spannung
- Stufenlos verstellbar
- Einsatz mittels Schraubenschlüssel SW 21 mm oder  $\frac{19}{16}$  Umschaltknarre
- Optimaler Halt beim Lösen des Ölfilters durch linksverzahnte Backen
- Für schwer zugängliche Filtergehäuse
- Anwendung im Rechts- und Linksbetrieb ermöglicht Befügung Schraubverbindung

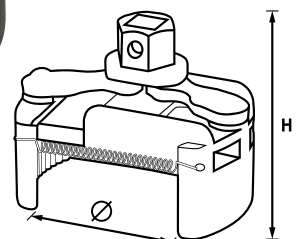

### Durchgängige Verzahnung



VIGOR No.	Höhe	■	Ø mm	EAN 4047728+	€
<b>V4413</b>	60	● 21 mm, $\frac{19}{16}$	60-80	044134	90,85
<b>V4414</b>	70	● 22 mm, $\frac{19}{16}$	80-115	044141	119,-
<b>V4415</b>	105	● 24 mm, $\frac{19}{16}$	115-140	062114	169,50

**V4701**, EAN 4047728073844

## Vakuumpumpe · Mini

- Manuelle Vakuumpumpe zum Absaugen und Einfüllen von Fahrzeugflüssigkeiten
- Gute Ablesbarkeit des Füllstands
- Genaue Dosierung und leichte Handhabung durch ergonomisches Design
- Fassungsvermögen: 100 ml
- Inklusive Gummischlauch mit Auslaufstopp-Kappe
- Für folgende Flüssigkeiten:
  - Dieselkraftstoffe
  - Benzin
  - Bremsflüssigkeit
  - Frostschutz
  - Motoröl
  - Getriebeöl
  - Servolenkungslöl

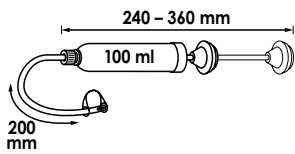

**24,70 €**  
zzgl. MwSt.

**V4369**, EAN 4047728043694

## Vakuumpumpe

- Ansaugen und Umfüllen von Kraftstoffen, Ölen und anderen Flüssigkeiten
- Fassungsvermögen: 350 ml
- Für u. a. folgende Flüssigkeiten:
  - Dieselkraftstoffe
  - Benzin
  - Bremsflüssigkeit
  - Frostschutz
  - Motoröl
  - Getriebeöl
  - Servolenkungslöl
- Inhalt:
  - 1 x Handpumpe 350 ml
  - 1 x PVC-Schlauch Ø 9,8 x 300 mm
  - 1 x Silikonschlauch Ø 11 x 300 mm
  - 1 x Tropfstopfen
  - 1 x Universal Adapter

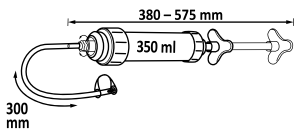

**57,05 €**  
zzgl. MwSt.

**V4201**, EAN 4047728042017

## Vakuumpumpe

- Manuelle Vakuumpumpe zum Absaugen und Einfüllen von Fahrzeugflüssigkeiten
- Vorbefüllen des Kraftstofffilters, bei Fahrzeugen ohne Vorfilterpumpe z.B. beim 2,0 l TDI FORD Galaxy und Mondeo
- Fassungsvermögen: 1,5 l
- Für folgende Flüssigkeiten:
  - Dieselkraftstoffe
  - Benzin
  - Bremsflüssigkeit
  - Frostschutz
  - Motoröl
  - Getriebeöl
  - Servolenkungslöl

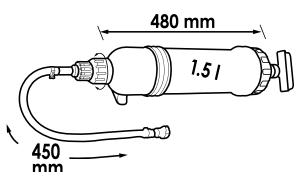

Geeignet für alle Kraftstoffe

**83,85 €**  
zzgl. MwSt.

**V4201-1**, EAN 4047728056588  
Dichtungssatz für V4201



**32,15 €**  
zzgl. MwSt.



**V4385N**, EAN 4047728072601

## Öl-Einfüllgerät mit Adapter Satz

- Befüllen von Getrieben und Differentialen mit Öl
- Inklusive Ölwanne und 16 Adapter für Fahrzeuge mit extrem beengten Bauräumen
- Befüllschlauch 1,5 m

Neue, verbesserte  
Satzzusammenstellung



VIGOR No.	Bezeichnung	Ausführung	EAN 4047728+	€
V3681	Adapter FORD · mit Gewindeanschluss		036818	15,75
V3682	Adapter BMW · abgelenkt		036825	18,65
V3683	Adapter VAG · kurz · abgelenkt		036832	18,65
V3684	Adapter VAG · lang · abgelenkt		036849	18,65
V3685	Adapter VAG · gerade · mit Gewindeanschluss		036856	15,75
V3686	Adapter MERCEDES-BENZ · 7-Gang Automatik		036863	19,80
V3687	Adapter VAG · DSG Direktschaltgetriebe		036870	19,80
V3688	Adapter VAG · CVT stufenlose Automatik		036887	19,80
V3689	Adapter Volvo · gerade		036894	19,80
V3690	Adapter ŠKODA · M 18x1,5 mm		036900	19,80
V3691	Adapter VW · Passat		036917	22,70
V4113	Adapter TOYOTA · LEXUS · 18x1,5		041133	23,40
V4114	Adapter Infiniti · 7 Speed M 8x1,0		041140	23,40
V4115	Multifunktions Adapter		041157	23,40
V4383	Adapter NISSAN · Juke M 12x1,25 mm		043830	14,70
V4384	Adapter MINI Cooper · M 14x1,5 mm		043847	18,65
V7285	Adapter NISSAN · Hybrid · M 10x1,5		072854	23,20
V7286	Adapter GM · M 12x1,75		072861	23,20
V7287	Adapter ŠKODA · M 18x1,5		072878	23,20
V7288	Adapter VAG · 7-Gang Doppelkupplung		072885	23,20

**357,- €**  
zzgl. MwSt.



## Bremsen

Bremswartung und Entlüftung

278–280

Bremskolben-Rückstellwerkzeuge

281–284

Bremsscheiben-Werkzeuge

285–286

Bördelgeräte

287–289

Inspektions-Werkzeuge

290–294



**V4411**, EAN 4047728044110

## Bremsentlüfter Satz 3 l · manuell

- Entlüftung von Brems- und Kupplungssystemen
- Betriebsdruck: max 1,4 bar
- Manometer-Bereich: 0 – 2 bar
- Ablassen des Drucks durch integriertes Druckablassventil
- Inhalt:
  - 3 Liter Tank
  - E20 Euro Adapter
  - Universal Adapter mit Kette
  - Verbindungs-Schlauch mit Schnellanschluss
  - Auffangbehälter mit Anschlussnippel für Bremssysteme

*Besonders geeignet für mobile Anwendung durch manuelle Druckaufbau-Funktion*



**Fassungsvermögen:**  
3 Liter

**150,50 €**  
zzgl. MwSt.



**V4668**, EAN 4047728046688

## Bremsflüssigkeit-Behälter

- Auffangbehälter zum Entlüften von Brems- und Kupplungssystemen
- Silikonschlauch, Länge: 550 mm
- Im Satz V4411 enthalten

*Geeignet für alle gängigen Entlüfterventile*



**Fassungsvermögen:**  
0,7 Liter

**31,10 €**  
zzgl. MwSt.





**V4381**, EAN 4047728**043816**

## Adapter für Bremswartungssysteme

- In Verbindung mit konventionellen Bremswartungs-Geräten
- Deckel aus langlebigem Aluminium
- Inhalt:
  - Adapter E 20 W für schwer zugängliche Ausgleichsbehälter, für fast alle europäischen Fahrzeuge
  - Adapter G 75 für ISUZU · MITSUBISHI · PROTON · SUBARU · SUZUKI · Volvo · KIA
  - Adapter B 35 für CHRYSLER · FORD · NISSAN · SUBARU · HYUNDAI
  - Universal Adapter mit Kettenbefestigung

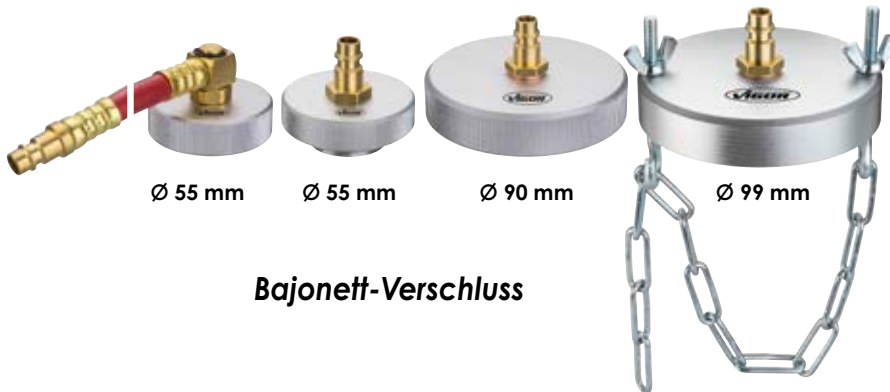

Ø 55 mm

Ø 55 mm

Ø 90 mm

Ø 99 mm

### Bajonett-Verschluss

*Einfache und nützliche Ergänzung zur Verwendung von Wartungsgeräten an nahezu allen Fahrzeugen*

VIGOR No.	Bezeichnung	Ausführung	EAN 4047728+	€
V4381-1	Adapter E 20 W für Bremswartungs-Systeme		046930	69,85
V4381-2	Adapter G 75 für Bremswartungs-Systeme		046947	65,20
V4381-3	Adapter B 35 für Bremswartungs-Systeme		046954	65,20
V4381-4	Universal Adapter mit Kettenbefestigung für Bremswartungs-Systeme		046961	69,85

**232,- €**  
zzgl. MwSt.



## V7471, EAN 4047728074711

### Bremsentlüfter Satz

- Entlüften von Bremsleitungssystemen, Wechsel der Bremsflüssigkeit ohne Demontage der Räder
- Auch zum Entlüften von Kupplungssystemen
- Komfortable Anwendung dank ergonomischer Spezialratsche
- Einfaches Öffnen und Schließen des Bremsnippels dank spezieller Gelenk-Ratsche
- Garantiert schneller Zugang zum Bremsennippel auch bei montiertem Rad
- Gute Kraftübertragung durch anwendungsoptimierten Handgriff
- Winkel-Kupplung in 90° Ausführung mit Rückstoßventil und Verdreherschutz
- Rückstoßventil verhindert Eindringen von Luft in das System



10 – 11 mm

**143,- €**  
zzgl. MwSt.



Optionales Zubehör (nicht im Lieferumfang enthalten)

VIGOR No.	Bezeichnung	Ausführung	SW	EAN 4047728+	€
V7471-A	90° Universal Adapter		-	074889	51,20
V7471-T	Silikon Schlauch		-	074896	14,30
V7471-TL	Gummischlauch · lang		-	074865	14,30
V7471-TS	Gummischlauch · kurz		-	074858	8,65
V7471-W	Bremsentlüfter-Ratsche 14 mm Sechskant		-	074872	51,20
V7471L-10	Steckschlüsseinsatz · lang · 10 mm		10 mm	074834	14,30
V7471L-11	Steckschlüsseinsatz · lang · 11 mm		11 mm	074827	14,30
V7471S-10	Steckschlüsseinsatz · kurz · 10 mm		10 mm	074759	10,60
V7471S-11	Steckschlüsseinsatz · kurz · 11 mm		11 mm	074766	10,60

VIGOR No.	Bezeichnung	Ausführung	SW	EAN 4047728+	€
V7471S-7	Steckschlüsseinsatz · kurz · 7 mm		7 mm	074728	10,60
V7471S-8	Steckschlüsseinsatz · kurz · 8 mm		8 mm	074735	10,60
V7471S-9	Steckschlüsseinsatz · kurz · 9 mm		9 mm	074742	10,60
V7471S-12	Steckschlüsseinsatz · kurz · 12 mm		12 mm	074773	10,60
V7471L-7	Steckschlüsseinsatz · lang · 7 mm		7 mm	074780	14,30
V7471L-8	Steckschlüsseinsatz · lang · 8 mm		8 mm	074797	14,30
V7471L-9	Steckschlüsseinsatz · lang · 9 mm		9 mm	074803	14,30
V7471L-12	Steckschlüsseinsatz · lang · 12 mm		12 mm	074841	14,30

## V7471/17, EAN 4047728077187

### Bremsentlüfter Komplett Satz

- Entlüften von Bremsleitungssystemen, Wechsel der Bremsflüssigkeit ohne Demontage der Räder
- Auch zum Entlüften von Kupplungssystemen
- Komfortable Anwendung dank ergonomischer Spezialratsche
- Einfaches Öffnen und Schließen des Bremsnippels dank spezieller Gelenk-Ratsche
- Garantiert schneller Zugang zum Bremsennippel auch bei montiertem Rad
- Gute Kraftübertragung durch anwendungsoptimierten Handgriff
- Winkel-Kupplung in 90° Ausführung mit Rückstoßventil und Verdreherschutz
- Rückstoßventil verhindert Eindringen von Luft in das System
- Steckschlüssel: SW 7 – 12 mm in kurzer und langer Ausführung im Lieferumfang



7 – 12 mm

**240,- €**  
zzgl. MwSt.



**V1711N**, EAN 4047728060738

## Bremskolben-Rückstellwerkzeug Satz · pneumatisch

- Drehen und Drücken von Bremskolben an fast allen Pkw
- Effizientes, beschädigungsfreies Arbeiten an Bremsanlagen
- Für rechts- sowie linksdrehende Bremskolben
- Ermöglicht kontrolliertes Zurückdrehen per Hand zusätzlich zur pneumatischen Unterstützung
- Schnellverbinder ermöglicht einfaches Aufsetzen der Adapter
- Automatischer Ausgleich bei unterschiedlichen Gewindesteigungen
- 23-teiliger Satz: 1 Druckluftspindel · 22 Adapterplatten



Jetzt noch größere Marktabdeckung



**198,50 €**  
zzgl. MwSt.

**V1711-1**, EAN 4047728067331

## Bremskolben-Rückstellwerkzeug · pneumatisch

- Für Rechts- und Linksgewinde
- Schützt vor Beschädigungen der Dichtungsmanschetten
- Ermöglicht zeitgleiches Betätigen und Drehen
- Magnet an der Aufnahme sorgt für sicheren Halt des Adapters



**99,40 €**  
zzgl. MwSt.



**V3760N**, EAN 4047728066310

## Bremskolben-Rückstellwerkzeug Satz

- Links- und rechtsdrehende Kolben
- Inklusive 4 Spezial Steckschlüssel-Einsätze
- Zurücksetzen durch Drücken und zeitgleiches Drehen des Bremskolbens
- Nummerierung der Adapterplatten zur detaillierten Zuordnung
- Aufnahmen der Spindeln sind magnetisch, für komfortables Arbeiten
- Inhalt:
  - 2 Spindeln (links- und rechtsdrehend)
  - 2 Winkelschlüssel (6 und 7 mm)
  - 2 Splinttreiber
  - 3 austauschbare Rückhalteplatten
  - 36 Rückhalteplatten und Adapter
  - 4 Spezial Bremsverschraubung-Einsätze
  - 1 Spindelfett
- Adapter ermöglichen Einsatz auch bei stark abgefahrenen Belägen sowie den Zusammenbau der Rücksteller im Bremsattel



**262,- €**

zzgl. MwSt.

VIGOR No.	Bezeichnung	Ausführung	■	Ø	Zapfendurchmesser	Zapfenhöhe	SW	EAN 4047728+	€
V3760-1	Adapterplatte 1		-	-	-	-	-	067164	5,50
V3760-2	Adapterplatte 2		-	51	6	9	-	066853	10,75
V3760-3	Adapterplatte 3		-	55	-	-	-	067201	8,40
V3760-4	Adapterplatte 4		-	32	5	2,5	-	066631	8,40
V3760-5	Adapterplatte 5		-	36	6	4	-	066648	10,75
V3760-6	Adapterplatte 6		-	42	6	4	-	066655	8,40
V3760-7	Adapterplatte 7		-	42	6	2	-	066662	8,40
V3760-11	Adapterplatte 11		-	-	-	-	-	066679	5,95
V3760-12	Adapterplatte 12		-	-	-	-	-	066686	5,95
V3760-A	Adapterplatte A		-	41	6	4	-	066693	10,25
V3760-B	Adapterplatte B		-	38	10	3	-	066709	10,25
V3760-C	Adapterplatte C		-	38	4	3	-	066716	10,75
V3760-D	Adapterplatte D		-	51	6	3	-	066723	11,40
V3760-E	Adapterplatte E		-	42	5	3	-	066730	9,55
V3760-F	Adapterplatte F		-	36	6	4	-	066747	11,40
V3760-G	Adapterplatte G		-	32	4	3	-	066754	8,40
V3760-J	Adapterplatte J		-	44	6	3	-	066761	11,40

# Bremskolben-Rückstellwerkzeuge



VIGOR No.	Bezeichnung	Ausführung	■	∅	Zapfendurchmesser	Zapfenhöhe	SW	EAN 4047728+	€
V3760-K1	Adapterplatte K1		-	54	10	7	-	066778	11,90
V3760-K2	Adapterplatte K2		-	45	6	4	-	066785	10,75
V3760-M	Adapterplatte M		-	32	6	3	-	066792	8,40
V3760-P	Adapterplatte P		-	38	4	4.5	-	066808	8,40
V3760-Q	Adapterplatte Q		-	32	5.5	3	-	066815	10,25
V3760-R	Adapterplatte R		-	36	6	4	-	066822	10,75
V3760-S	Adapterplatte S		-	38	4	3	-	066839	10,75
V3760-T	Adapterplatte T		-	28	5	4	-	066952	10,75
V3760-V	Adapterplatte V		-	40	4	2.5	-	066969	10,25
V3760-X	Adapterplatte X		-	-	-	-	-	066976	10,25
V3760-Z	Adapterplatte Z		-	30	4	4.5	-	066983	10,25
V3760-8	Adapterplatte 8		-	48	5.5	3	-	066990	10,75
V3760-9	Adapterplatte 9		-	54	5.5	3	-	067003	11,90
V3760-0	Adapterplatte 0		-	63.5	5.5	3	-	067010	11,90
V3760-0-DISC	Adapterplatte 0-DISC		-	59	-	-	-	067027	7,15
V3760-K	Adapterplatte K		-	54	8	4	-	067034	10,75
V3760-N	Adapterplatte N		-	32	12	5	-	067041	10,25
V3760-IV	Adapterplatte IV		-	42	6	9	-	067058	10,25
V3760-H6	Winkelschraubendreher H6		-	-	-	-	-	067065	10,25
V3760-H7	Winkelschraubendreher H7		-	-	-	-	-	067072	10,25
V3760-A1	Adapterplatte A1		-	40	5.5	4	-	067089	10,75
V3760-B1	Adapterplatte B1		-	45	6	5	-	067096	10,75
V3760-F1	Adapterplatte F1		-	44	4	3.5	-	067102	10,75
V3760-P1	Adapterplatte P1		-	37	6	3.5	-	067119	10,75
V3760-G1	Druckplatte G1		-	42	5	5	-	067133	10,75
V6632	Steckschlüsseinsatz			-	-	-	9 mm	066327	19,95
V6633	Steckschlüsseinsatz			-	-	-	22 mm	066334	19,95
V6634	Steckschlüsseinsatz			-	-	-	20 mm	066341	19,95
V6635	Steckschlüsseinsatz			-	-	-	11.5 mm	066358	19,95

**V3760-VW, EAN 4047728071666**  
**Adapter VW**



**11,90 €**  
 zzgl. MwSt.

**V7132N**, EAN 4047728076500

## Bremskolben-Rückstellwerkzeug Satz · hydraulisch

- Für Mehrkolben Bremsanlagen  
Gleichmäßiges Rücksetzen des Bremskolbens,  
ohne Beschädigung an Kolben und Dichtung
- Auswechselbare Pressbacken für  
Spannbereich 30 – 70 mm
- Pressbacken 360° einstellbar  
– optimale Anpassung
- Ideal für Schwimmsättel und Festsättel
- Einstellbar auf unterschiedlichste  
Bremsattel-Formen und Kolbenzahl
- Pressplatten: 2x L 90 x B 2 mm · 2x L  
90 x B 4 mm · 2x L 150 x B 4 mm
- Maximale Kraftübertragung: 2 t



**240,- €**

zzgl. MwSt.



**V7158**, EAN 4047728071581

## Bremssattel-Verschraubungs Satz

- Bremssattel-Verschraubungen an z.B. VW · AUDI · PORSCHE · MERCEDES-BENZ · BMW · FORD · MAZDA · Volvo
- Inklusive aller üblichen Profilgrößen zur Demontage / Montage des Bremssattels
- Sonderprofile zum Lösen der Verschraubungen von geteilten Bremssätteln
- Ideal für Schwimm- und Festbremssattel



12



**99,- €**  
zzgl. MwSt.

VIGOR No.	Bezeichnung	Ausführung	■	●	SW	L mm	EAN 4047728+	€
V6633	Steckschlüsseinsatz		$12\frac{1}{2}$	-	22 mm	48	066334	19,95
V6634	Steckschlüsseinsatz		$12\frac{1}{2}$	-	20 mm	38	066341	19,95
V6635	Steckschlüsseinsatz		$12\frac{1}{2}$	-	11.5 mm	50	066358	19,95
V6636	Steckschlüsseinsatz		$12\frac{1}{2}$	-	14 mm	50	071406	23,20
V7158-1	Steckschlüsseinsatz		$10\frac{3}{8}$	●	7 mm	24	071598	11,55
V7158-2	Steckschlüsseinsatz		$10\frac{3}{8}$	●	8 mm	24	071604	11,55
V7158-3	Steckschlüsseinsatz		$6.3\frac{1}{4}$	●	9 mm	20	071611	11,55
V7158-4	Steckschlüsseinsatz		$10\frac{3}{8}$	○	9 mm	50	071628	11,55
V7158-5	Steckschlüsseinsatz		$10\frac{3}{8}$	○	7 mm	65	071635	11,55
V7158-6	Steckschlüsseinsatz		$10\frac{3}{8}$	○	7 mm	92	071642	11,55
V7158-7	Steckschlüsseinsatz		$10\frac{3}{8}$	○	11 mm	100	071659	11,55
V7158-8	Steckschlüsseinsatz		$10\frac{3}{8}$	○	8 mm	30	071888	17,35

**V6632**, EAN 4047728066327

## Steckschlüsseinsatz

- Bremssattel-Verschraubungen an z.B. VW · AUDI · PORSCHE · MERCEDES-BENZ · BMW · FORD · MAZDA · Volvo

SW 9 mm



$10\frac{3}{8}$

**19,95 €**  
zzgl. MwSt.

**V4930**, EAN 4047728**049306**

## Bremsscheiben Messschieber

- Schnelle, effektive Bestimmung des Bremsscheiben-Durchmessers ohne vorherige Demontage des Rades
- Zeitersparnis durch eindeutige Identifikation der verbauten Bremsanlage (Vorteil: weniger Fehlbestellungen)
- Spannungsbereich universell: 200 – 400 mm

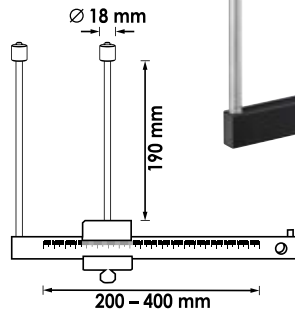

Durchführung der Messung  
ohne Rad-Demontage

**122,50 €**  
zzgl. MwSt.

**V4399**, EAN 4047728**043991**

## Bremsscheiben Dickenmesser

- Schneller, effizienter Test zur Bestimmung der aktuellen Bremsscheiben-Dicke
- Hinweis: Mindestverschleißgrenzen der Bremsscheiben entnehmen Sie dem Fahrzeughersteller-Handbuch

Anzeigebereich 0 – 45 mm

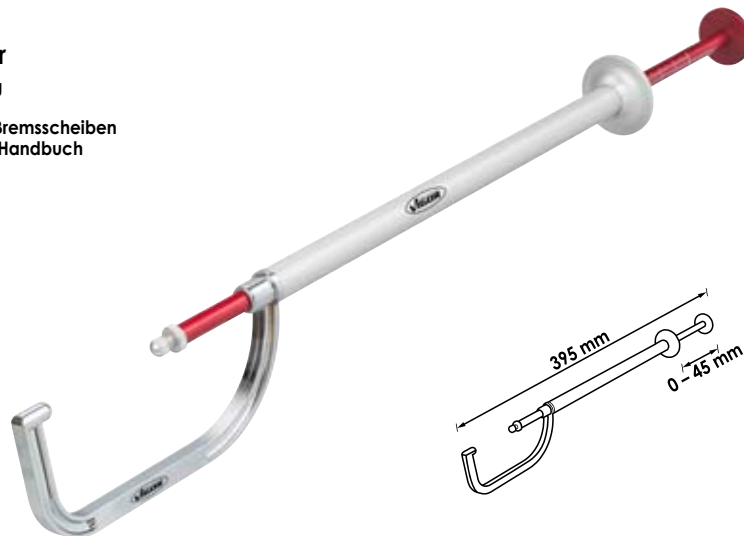
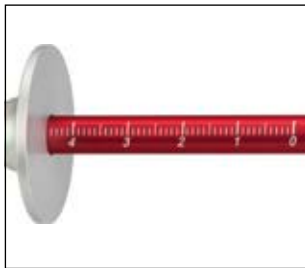

Durchführung der Messung  
ohne Rad-Demontage

**57,05 €**  
zzgl. MwSt.

**V7401**, EAN 4047728**074018**

## Bremsscheiben-Dickenmesser · digital

- Messen der Mindest-Stärke von Bremsscheiben
- Durchführung der Messung ohne Rad-Demontage
- Digitale Anzeige LCD Display
- Edelstahlausführung
- Hinweis: Mindestverschleißgrenzen der Bremsscheiben im Fahrzeughersteller-Handbuch beachten
- Inklusive 3 Volt Batterie CR2032
- Messbereich von 0 – 80 mm



**115,50 €**  
zzgl. MwSt.



## V4416, EAN 4047728044165

### Bördelgerät für Ø 4,75 mm

- Ausschließlich für DIN Bördelungen
- Leicht und handlich
- Genaue Positionierung der Bremsleitung im Gerät erfolgt mittels Abstandsadapter
- Einsatz an Brems- bzw. Hydraulikleitungen direkt am Fahrzeug
- Für dünnwandige Stahl-, Aluminium- und Kupferleitungen (Metrisch / Zoll)
- Keine Beschädigung beschichteter Leitungen
- Für DIN F-Bördel 180°



Für DIN F-Bördel



Besonders geeignet für den Einsatz direkt am Fahrzeug

VIGOR No.	Bezeichnung	Ausführung	EAN 4047728+	€
V4416-1	DIN Bördelschraube 4,75 mm		049313	20,30
V4416-2	Gewindehülse		049337	20,30
V4416-3	Abstandsschraube		049344	9,80
V4416-4	Schraube		049351	2,45
V4416-5	Griff		049375	9,80

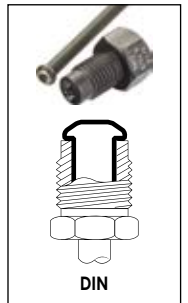

**87,35 €**  
zzgl. MwSt.

## V4697, EAN 4047728046978

### Bördelgerät für Ø 4,75 mm

- Bördelungen von Ø 4,75 mm Leitungen nach DIN und SAE Standard
- Extrem kleine Konstruktion gewährleistet Arbeiten auch bei engen Platzverhältnissen
- Keine Beschädigung beschichteter Leitungen
- Abstands Adapter verhindert Fehlpositionierung der Bremsleitung
- Für Stahl-, Aluminium- und Kupferleitungen
- Für DIN F-Bördel 180°, sowie SAE F Doppel-Bördel
- Inhalt:
  - 1 Grundgerät
  - 1 DIN-Bördeladapter
  - 1 SAE-Bördeladapter
  - 1 Abstands Adapter
  - 1 Spezialfett



Für DIN · SAE und F-Bördel



Durch einfache und handliche Bedienung besonders geeignet für den direkten Einsatz am Fahrzeug

VIGOR No.	Bezeichnung	Ausführung	EAN 4047728+	€
V4416-1	DIN Bördelschraube 4,75 mm		049313	20,30
V4416-2	Gewindehülse		049337	20,30
V4416-3	Abstandsschraube		049344	9,80
V4416-4	Schraube		049351	2,45
V4697-1	Bördelschraube (SAE) · 4,75 mm		049320	26,70
V4697-2	Griff		049368	12,70

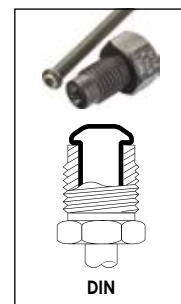

**159,- €**  
zzgl. MwSt.



**V1728**, EAN 4047728017282

## Bördelgerät Satz

- Direkter Einsatz an Brems- bzw. Hydraulikleitungen am Fahrzeug
- Für dünnwandige Stahl-, Aluminium- und Kupferleitungen (Metrisch / Zoll)
- Anfertigung von Konvex und Doppelbördelungen (DIN/SAE-Standards)
- Keine Beschädigung beschichteter Leitungen
- Für DIN F-Bördel 180°, sowie SAE F Doppel-Bördel, ebenso wie den einfachen D Bördel



## Für DIN · SAE Bördel



VIGOR No.	Bezeichnung	Ausführung	EAN 4047728+	€
V2466	Schnellwechsel-Halterung		024662	64,85
V2559	Grundgerät		025591	158,50
V2467	Hydraulik-Spindel		024679	127,-
V2558	Druckstück 90° DIN / SAE		025584	23,40
V2553	Druckstück DIN/SAE		025539	23,40
V2554	Druckstück DIN/SAE		025546	23,40
V2556	Druckstück DIN/SAE		025560	23,40
V2555	Druckstück DIN/SAE		025553	23,40
V2626	Rohrschneider		026260	16,-
V2551	Spannbacken-Paar 5 mm		025515	37,15
V2552	Spannbacken-Paar 6 mm		025522	37,15
V2540	Spannbacken-Paar 4,75 mm		025409	37,15
V1782	Rohrbieger		017824	28,65

**348,50 €**  
zzgl. MwSt.

**V5513**, EAN 4047728055130

## Bördelgerät Satz

- Bördeln von Stahl-, Aluminium-, oder Kupfer-Bremsleitungen mit  $\varnothing 4,75 \cdot 5 \cdot 5,15 \cdot 5,25 \cdot 6$  mm
- Moderne BMW- und VAG-Bremsleitungen sind mit zusätzlicher Kunststoffschicht überzogen ( $\varnothing 5,15$  bzw.  $5,25$  mm)
- Bördeln ist mit handelsüblichen Bördelgeräten nicht möglich
- Ausschließlich für DIN Bördelungen
- Direkter Einsatz an Brems- bzw. Hydraulikleitungen am Fahrzeug

*Für neuartige VAG und BMW Bremsleitungen mit zusätzlicher Ummantelung*

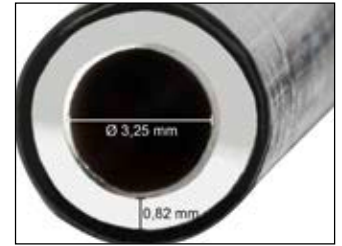

Neuartige Bremsleitung



Positionierung der Leitung um Ummantelung abzuschaben



Aufstecken der Überwurfmutter



Positionieren der Leitung



DIN-Bördelvorgang



**361,- €**  
zzgl. MwSt.

VIGOR No.	Bezeichnung	Ausführung	EAN 4047728+	€
V5513-1	DIN Bördelschraube 6 mm		055147	22,85
V5513-2	Leitungsschneider 3 – 16 mm		055154	26,55
V5513-3	Leitungsschaber 3 – 16 mm		055161	37,95
V4416-1	DIN Bördelschraube 4,75 mm		049313	20,30
V4416-2	Gewindehülse		049337	20,30
V4416-3	Abstandsschraube		049344	9,80
V4416-4	Schraube		049351	2,45
V4697-2	Griff		049368	12,70
V1782	Rohrbieger		017824	28,65



**V5649**, EAN 4047728056496

## Entgrater für Bremsleitungen · innen / außen

- Entgraten von Bremsleitungen
- Für Rohr-Innen-Ø 3 – 12 mm
- Für Rohr-Außen-Ø 4 – 14 mm
- Entgraten von Bremsleitungen
- Für Stahl, Kupfer, Edelstahl, Aluminium Leitungen

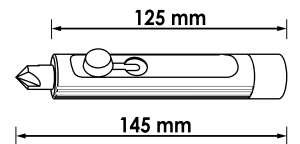

**40,20 €**  
zzgl. MwSt.

**V2789N**, EAN 4047728062824

## Inspektions-Werkzeug für Brems- und Kraftstoffleitungen

- Aufspüren verborgener Korrosionsstellen bei Hauptuntersuchung
- 12 Abstreifflächen zur Beseitigung von Schmutz und Korrosion verschiedener Leitungen
- Ø 3,5 mm · 4,0 mm · 4,75 mm

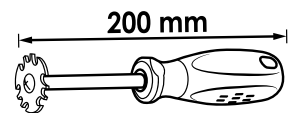

**15,50 €**  
zzgl. MwSt.

**V5691**, EAN 4047728056915

## Bremssattelfeile

- Entfernen von Bremsstaub, Rost und Verschmutzungen am Bremssattel ohne Beschädigung der Bremsmanschetten
- Extrem schmale Bauform ermöglicht hohe Flexibilität
- Alle vier Seiten des Vierkants mit 2 unterschiedlichen Stärken (Hieb) verzahnt
- Breite Vierkant: 9 mm

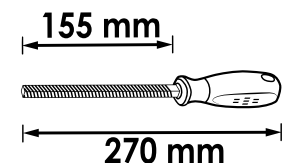
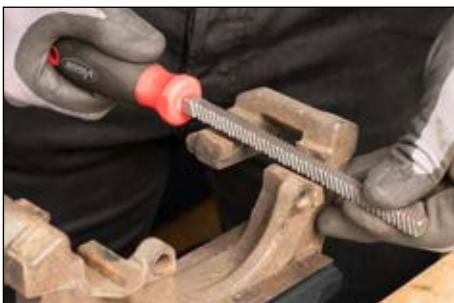

**39,- €**  
zzgl. MwSt.

**V5909**, EAN 4047728**059091**

## Bremshaken

- Aufhängen des Bremsstells bei Bremsarbeiten (Beschädigung des Bremschlauchs wird verhindert)
- Auch zum Aufhängen von Schläuchen oder Kabeln
- Oberfläche: tauchisoliert



**16,35 €**  
zzgl. MwSt.

**V2250**, EAN 4047728**022507**

## Bremssattel-Bürste · Stahl

- Entfernen von hartnäckigem Bremsstaub
- Sehr schmale Ausführung



Mit Aufhängeloch

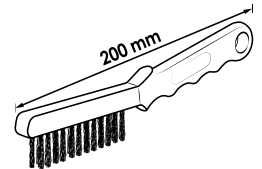

**11,90 €**  
zzgl. MwSt.

**V2249**, EAN 4047728**022491**

## Bremssattel-Bürste · Messing

- Reinigen von Aluminium-Bremssätteln
- Entfernen von hartnäckigem Bremsstaub
- Für enge Bremssattelschächte



Mit Aufhängeloch

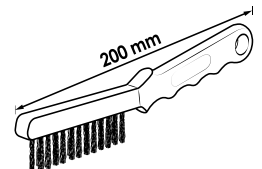

**15,50 €**  
zzgl. MwSt.



**V6917**, EAN 4047728069175

## Bremsleitungs Ratschen-Rohrschneider

- Platzsparend, mit Ratschen-Mechanismus  
Für 4,75 mm Bremsleitungen
- Ratschen-Mechanismus im Kopf des Werkzeuges minimiert Platzbedarf – direkt am Fahrzeug verwendbar
- Kein Nachstellen des Schneidrades durch Selbstjustierung
- Schnelleres Schneidergebnis als konventionelle Leitungsschneider
- Einstellen der selbstjustierenden Schneidkraft möglich
- Ersatzklingen V6917-REP



Selbstjustierend

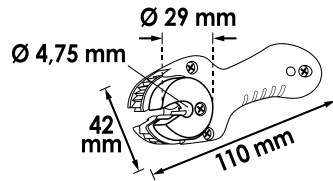

**45,40 €**  
zzgl. MwSt.



**V6917-REP**, EAN 4047728069199

## Ersatzschneidrad für Bremsleitungs Ratschen-Rohrschneider V6917



**5,95 €**  
zzgl. MwSt.

**V1782**, EAN 4047728017824

## Rohrbieger

- Für Kupfer-, Messing-, Alu- und Weichstahlrohre
- Biegen bis zu 90°
- Biegen von Rohren mit 3 mm, 4,75 mm und 6 mm Ø

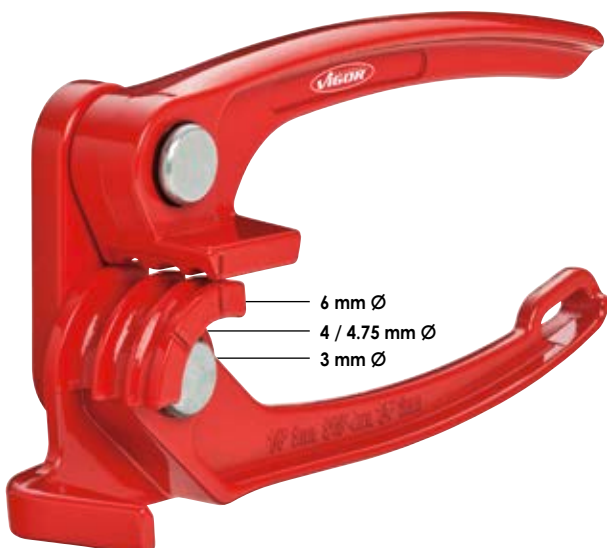

6 mm Ø  
4 / 4,75 mm Ø  
3 mm Ø

**28,65 €**  
zzgl. MwSt.

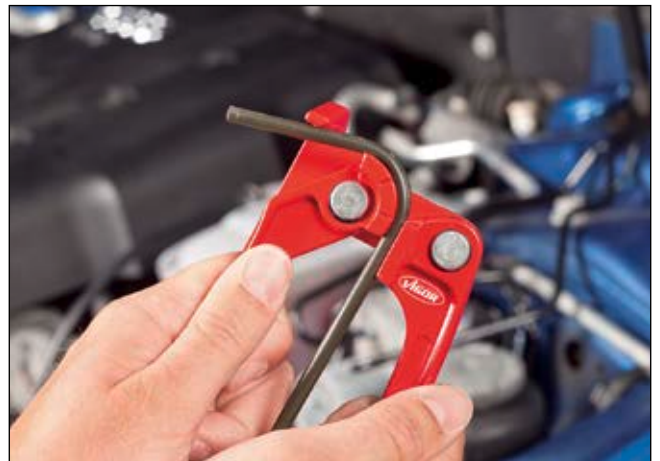

**V7244**, EAN 4047728072441

## Bremseleitung-Begradigungswerkzeug Ø 4,75 mm

- Einfaches Begradigen von 4,75 mm Leitungen
- Speziell für Bremsleitungen aus Stahl oder Kupfer-Nickel
- Effektive Methode, um unförmige Leitungen zu begradigen, speziell für Rollenware
- Einfaches Hin- und Herschieben ist als Anwendungsimpuls ausreichend
- Zielgerichtetes Begradigen verringert den Materialaufwand
- Ersetzt konventionelles, unpräzises Formen von Leitungen



**149,- €**  
zzgl. MwSt.

**V7259**, EAN 4047728072595

## Bremseleitung-Biegewerkzeug Ø 4,75 mm

- Biegevorrichtung zum einfachen Duplizieren von formtreuen Bremsleitungen



**34,85 €**  
zzgl. MwSt.



**V7120**, EAN 4047728077200

## Bremseleitung-Haltewerkzeug

- Beschädigungsfreies Halten von  $\varnothing$  4,75 mm Bremsleitungen durch optimierte Klemmung
- Die Bremsleitung kann im eingebauten Zustand nachgebogen werden, um eine exakte Form des Originals nachzubilden
- Für Stahl, Kupfer-Nickel sowie kunststoffummantelte Bremsleitungen

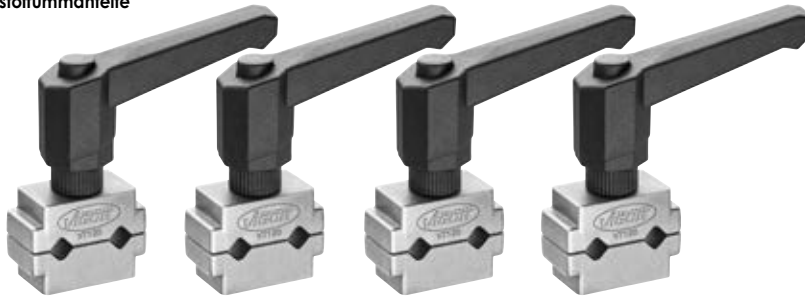

**77,-€**  
zzgl. MwSt.

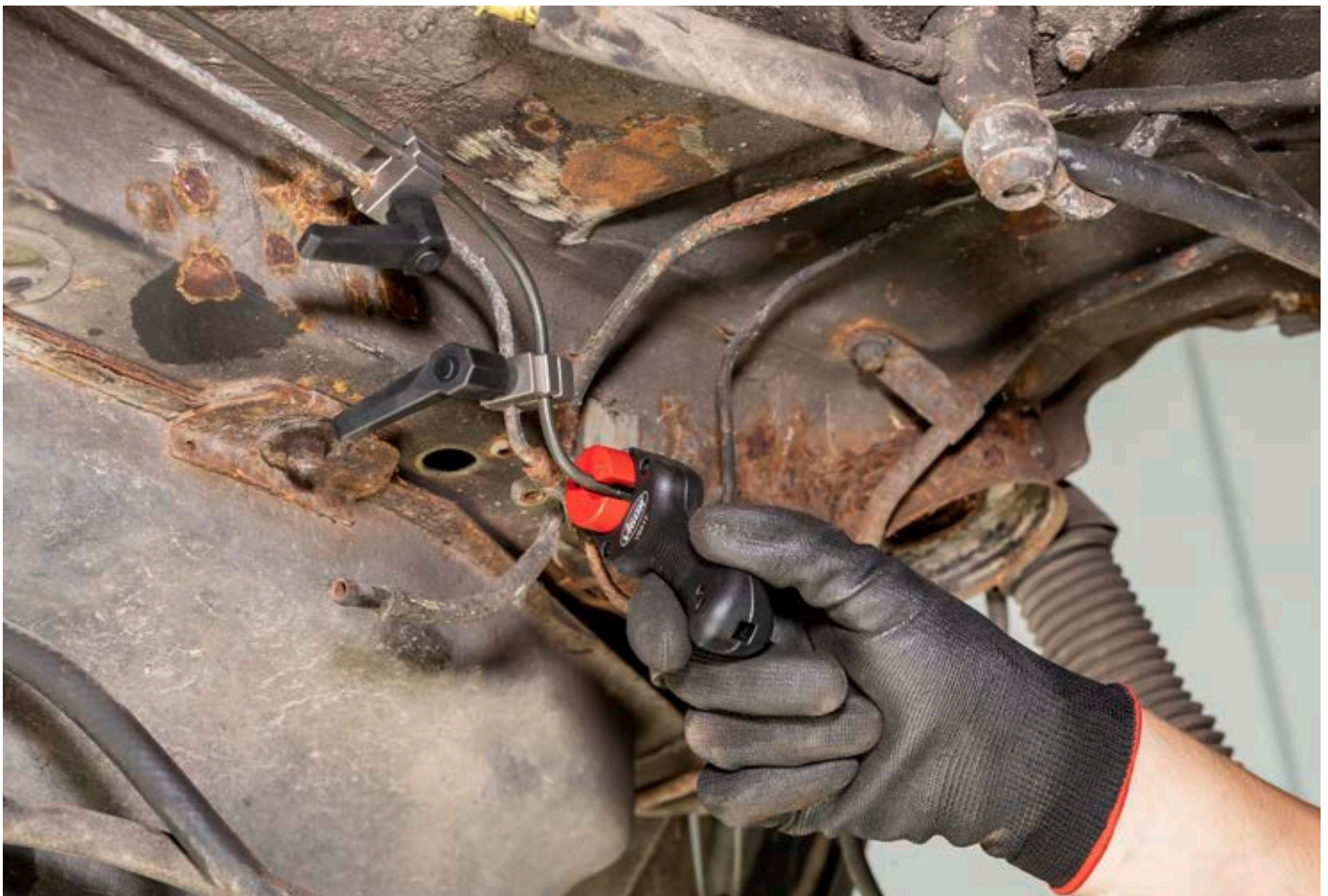





## Räder / Reifen

Schlagschrauber-Krafteinsätze

296-298

Wagenheber und Böcke

299-302

Räder / Reifen-Werkzeuge

303-306



**V6311**, EAN 4047728077798

## Schlagschrauber Steckschlüsseleinsatz · TESLA

- 22,2 mm Sechskant beziehungsweise 7/8"
- 21 mm Radmuttern können sich, aufgrund von Witterungsbedingungen, plastisch verformen und ausdehnen

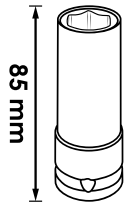

**20,45 €**  
zzgl. MwSt.

**V4309**, EAN 4047728043090

## Schlagschrauber Steckschlüsseleinsatz · MERCEDES-BENZ

- Befähigung von Radschrauben mit MERCEDES-BENZ Spezialprofil
- Für folgende Modelle:
  - C-Klasse · GLK (W204)
  - E-Klasse (W211 · W212 · W207)
  - SLK (W172)
  - M-Klasse (W164 · W166)
  - CL-Klasse (W216)
  - S-Klasse (W221, W222)
  - MAYBACH
- Für Maschinenbetätigung

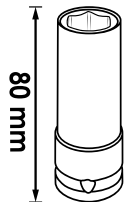

**20,55 €**  
zzgl. MwSt.

**V6309**, EAN 4047728075534

## Schlagschrauber Steckschlüssel Satz

- Betätigung von beschädigten 19 mm FORD Radmuttern
- Für z.B.: FORD B-Max · C-Max · Fiesta · Focus · Mondeo · Transit
- Inhalt:
  - 18,5 mm Schlagschrauber Steckschlüsseleinsatz für Radmuttern mit fehlender Chromkappe
  - 19,5 mm Schlagschrauber Steckschlüsseleinsatz für Radmuttern mit verformter Chromkappe

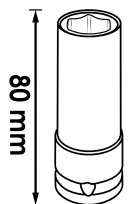
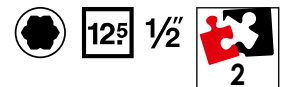

**28,80 €**  
zzgl. MwSt.

**V5930**, EAN 4047728059305

## Schlagschrauber Steckschlüsseleinsatz · lang

- Beschädigungsfreie Betätigung von Radschrauben durch mitdrehenden Kunststoffschutz
- Für Maschinenbetätigung

Vergleich Standard-Steckschlüsseleinsatz zu extra langem Steckschlüsseleinsatz

SW 17 mm

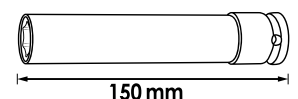

**34,90 €**  
zzgl. MwSt.

**V5931**, EAN 4047728060318

## Schlagschrauber Steckschlüsseinsatz · lang

- Beschädigungsfreie Betätigung von Radschrauben durch mitdrehenden Kunststoffschutz
- Für Maschinenbetätigung



SW 19 mm

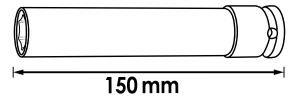

**34,90 €**  
zzgl. MwSt.

Vergleich Standard-Steckschlüsseinsatz zu extra langem Steckschlüsseinsatz



**V5932**, EAN 4047728079617

## Schlagschrauber Steckschlüsseinsatz · lang

- Beschädigungsfreie Betätigung von Radschrauben durch mitdrehenden Kunststoffschutz
- Für Maschinenbetätigung



SW 21 mm

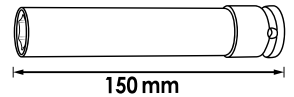

**34,90 €**  
zzgl. MwSt.

**NEU**

**V6312/10**, EAN 4047728077804

## Schlagschrauber Steckschlüsseinsatz Satz

- Beschädigungsfreie Betätigung von Radschrauben durch mitdrehenden Kunststoffschutz
- Satz mit allen benötigten Steckschlüsseinsätzen
- Für Maschinenbetätigung



**122,50 €**  
zzgl. MwSt.



**V5933/3**, EAN 4047728079624

## Schlagschrauber Steckschlüssel Satz · extra lang

- Beschädigungsfreie Betätigung von Radschrauben durch mitdrehenden Kunststoffschutz
- Extra lange Ausführung
- SW 17 · 19 · 21 mm
- Für Maschinenbetätigung

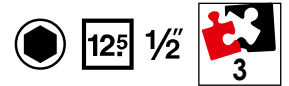

**NEU**

VIGOR No.	■	Ø	SW	← L → mm	EAN 4047728+	€
V5930		26	17 mm	150	059305	34,90
V5931		28	19 mm	150	060318	34,90
V5932		30	21 mm	150	079617	34,90

**89,- €**  
zzgl. MwSt.

**V2522**, EAN 4047728025225

## Schlagschrauber Steckschlüsseleinsatz Satz

- Für Maschinenbetätigung

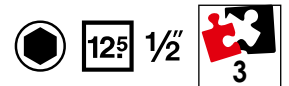

VIGOR No.	SW	← L → mm	EAN 4047728+	€
V2472	17 mm	85	024723	13,70
V2473	19 mm	85	024730	15,-
V2474	21 mm	85	024747	16,45

**41,40 €**  
zzgl. MwSt.

**V2257**, EAN 4047728022576

## Schlagschrauber Steckschlüsseleinsatz Satz

- Für Maschinenbetätigung

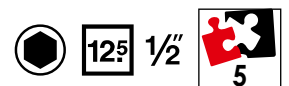

VIGOR No.	SW	← L → mm	EAN 4047728+	€
V2471	15 mm	85	024716	13,70
V2472	17 mm	85	024723	13,70
V2473	19 mm	85	024730	15,-
V2474	21 mm	85	024747	16,45
V2475	22 mm	85	024754	17,75

**63,55 €**  
zzgl. MwSt.

# Wagenheber und Böcke



**V2481**, EAN 4047728024815

## Hydraulik Alu Rangier-Wagenheber 1,35 Tonnen

- Radwechsel am Fahrzeug bzw. Reparaturen unter dem Fahrzeug, bei denen eine Hebebühne nicht notwendig ist
- $\approx$  10 kg

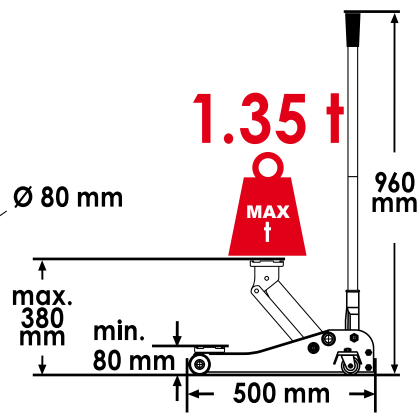
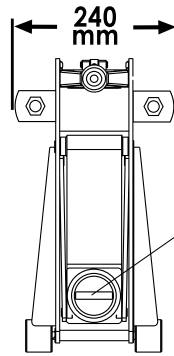

Alu – nur 10 kg

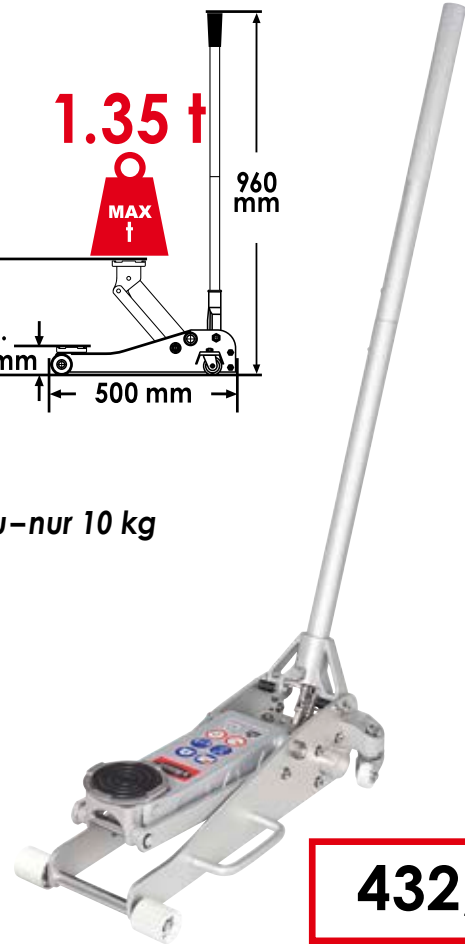

**432,- €**  
zzgl. MwSt.

VIGOR No.	Bezeichnung	EAN 4047728+	€
V2631	Bockrolle (Paar)	026314	25,40
V2632	Lenkrolle (Paar)	026321	25,40
V2639	Hydraulik-Einheit	026390	239,-
V2640	Gummi-Auflage	026406	12,-

**V6028**, EAN 4047728060288

## Hydraulik Rangier-Wagenheber 2 Tonnen · ultraflach

- Radwechsel am Fahrzeug bzw. Reparaturen unter dem Fahrzeug, bei denen eine Hebebühne nicht notwendig ist
- Robuste Gummiauflage für sicheren Halt
- Schneller Hub dank Turbo-Lift-Funktion
- Solider Stahlkorpus – garantiert hohe Qualität
- Geräuscharme Rollen aus Polyurethan
- $\approx$  32 kg

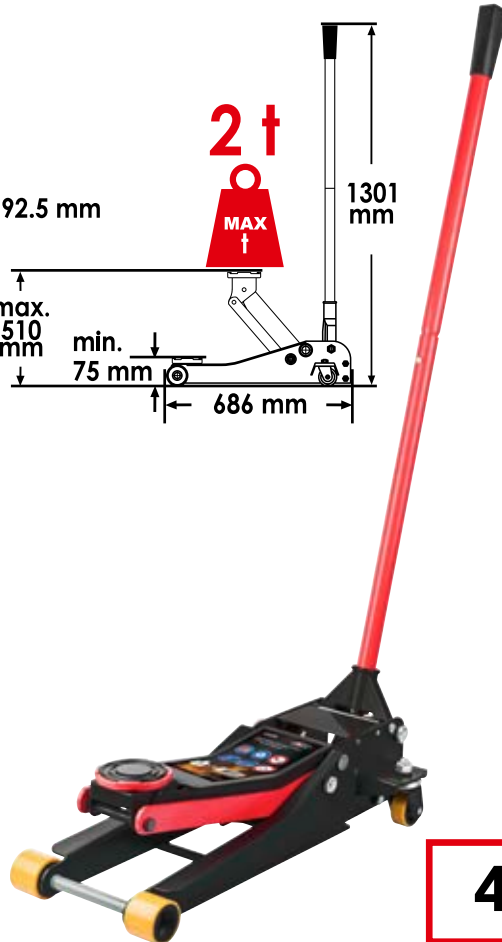
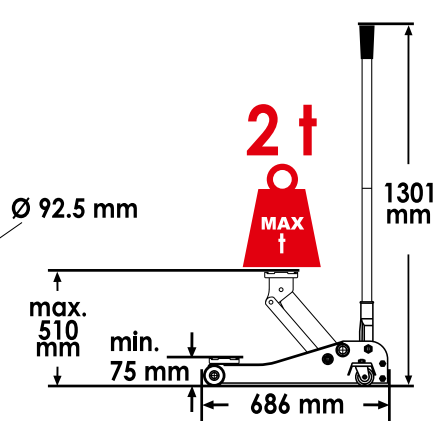
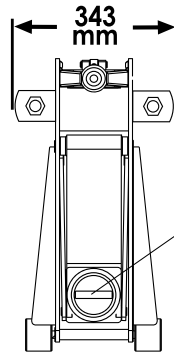

**432,- €**  
zzgl. MwSt.

VIGOR No.	Bezeichnung	EAN 4047728+	€
V6028-1	Bockrolle (Paar)	062503	25,40
V6028-2	Lenkrolle (Paar)	062497	25,40
V6028-3	Gummi-Auflage	062480	12,-
V6028-4	Hydraulik-Einheit für V6028	062473	112,-



**V6031**, EAN 4047728071109

## Hydraulik Rangier-Wagenheber 2 Tonnen · extra lang

- Radwechsel am Fahrzeug bzw. Reparaturen unter dem Fahrzeug, bei denen eine Hebebühne nicht notwendig ist
- $\approx$  42 kg

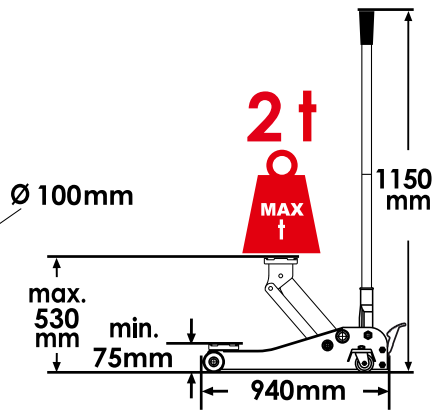
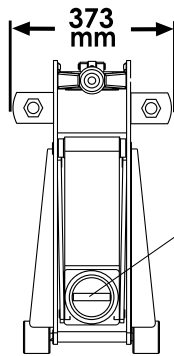

**478,50 €**  
zzgl. MwSt.

VIGOR No.	Bezeichnung	EAN 4047728+	€
V6031-1	Bockrolle (Paar)	075879	37,70
V6031-2	Lenkrolle (Paar)	075886	32,30
V6031-3	Gummi-Auflage	075893	12,-

**V6029**, EAN 4047728069786

## Hydraulik Rangier- Wagenheber 3 Tonnen

- Radwechsel am Fahrzeug bzw. Reparaturen unter dem Fahrzeug, bei denen eine Hebebühne nicht notwendig ist
- $\approx$  31 kg
- Kompakte Bauform
- Geräuscharme Rollen aus Polyurethan

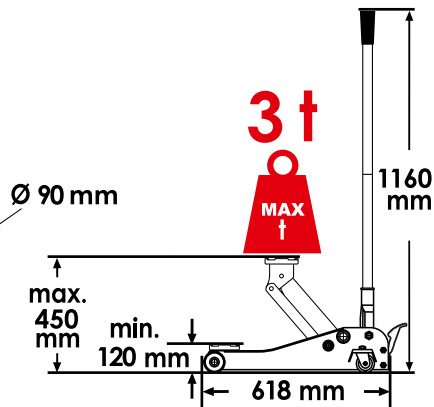
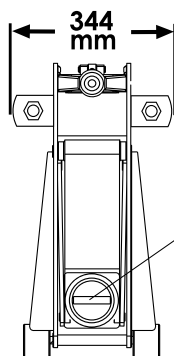

Fußpedal ermöglicht  
rasches Ansetzen an der  
Wagenheber-Aufnahme

**468,- €**  
zzgl. MwSt.

VIGOR No.	Bezeichnung	EAN 4047728+	€
V6029-1	Bockrolle (Paar)	075855	37,70
V6029-2	Lenkrolle (Paar)	075848	32,30
V6029-3	Gummi-Auflage	075862	12,-

# Wagenheber und Böcke



**V2478**, EAN 4047728024785

## Flaschen-Wagenheber 6 Tonnen

- Horizontaler und vertikaler Einsatz
- ⚖️ 4,4 kg

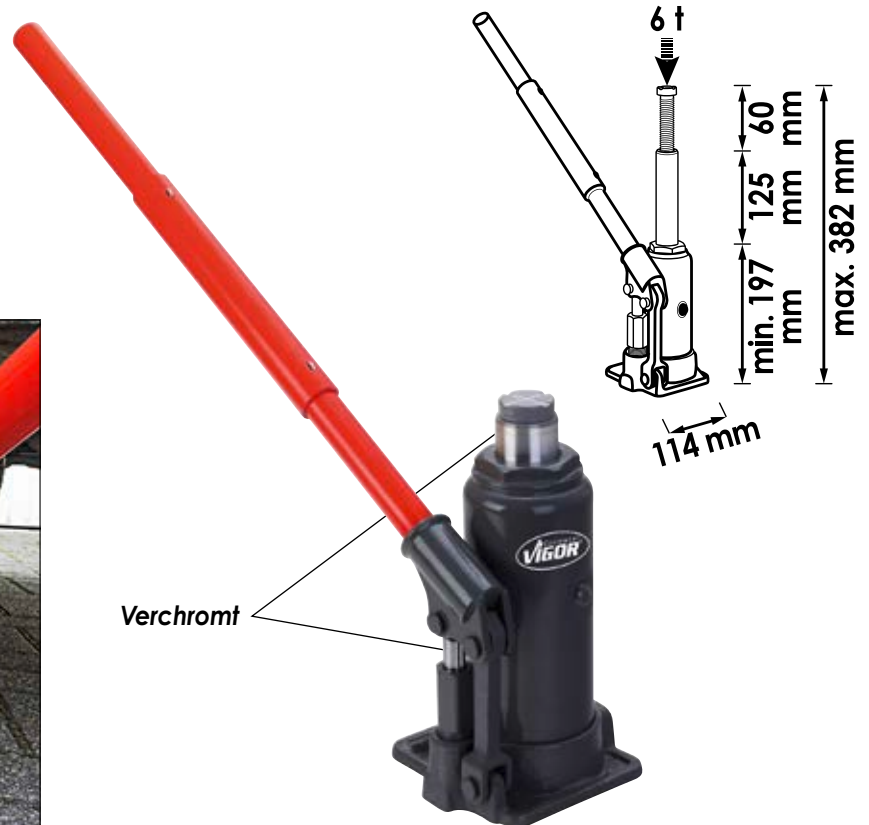

**64,80 €**  
zzgl. MwSt.

**V2477**, EAN 4047728024778

## Unterstellbock Satz 3 Tonnen

- ⚖️ 5,2 kg pro Paar
- Tragkraft: 3 Tonnen
- Höhe 315 – 460 mm
- Tiefe: 230 mm

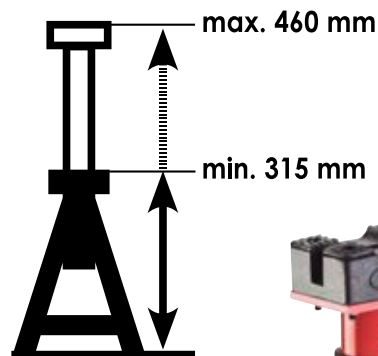

Preis pro Paar

**114,50 €**  
zzgl. MwSt.

VIGOR No.	Bezeichnung	EAN	€
V2762	Gummi-Auflage	4047728+027625	11,90



**V2648**, EAN 4047728**026482**

## Unterstellbock Satz 6 Tonnen

- 11 kg pro Paar
- Tragkraft: 6 Tonnen
- Höhe 370 – 575 mm
- Tiefe: 300 mm

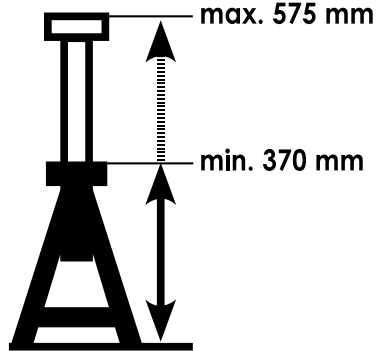

Preis pro Paar

**222,- €**

zzgl. MwSt.

VIGOR No.	Bezeichnung	EAN 4047728+	€
V2762	Gummi-Auflage	027625	11,90





**V3563**, EAN 4047728**035637**

## Reifen- und Montagehebel mit Kunststoff-Belag

- Auf- und Abziehen der Reifen an Stahl- und insbesondere Alu-Felgen
- Länge: 500 mm



**32,05 €**  
zzgl. MwSt.

Verchromt

Mit verschraubtem, auswechselbarem Kunststoff-Belag, inklusive Schrauben



VIGOR No.	Bezeichnung	EAN 4047728+	€
V3615	Kunststoff-Belag mit Schrauben	036153	10,60

**V2512**, EAN 4047728**025126**

## Klebegewicht-Entferner Satz

- Demontage Klebegewichten auf Alufelgen bei Pkw und Motorrad
- Lösemittelbeständig
- Mittels Feile nachschleifbar
- Auch zum Ablösen von Etiketten, Klebe- und Typenschildern
- Oberflächen werden nicht beschädigt



VIGOR No.	h mm	L mm	EAN 4047728+	€
V2513	19	500	025133	10,75
V2514	22	500	025140	11,90
V2515	25	500	025157	12,60
V2516	38	500	025164	13,15

**34,95 €**  
zzgl. MwSt.

**V1657**, EAN 4047728**016575**

## Auswuchtgewicht-Zange

- Befestigen, Lösen und Abschneiden von Auswuchtgewichten

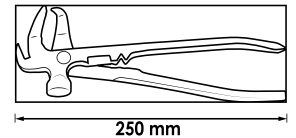

**29,95 €**  
zzgl. MwSt.

**V1584**, EAN 4047728**015844**

## Profiltiefenmesser

- Messung von Profiltiefen, Bremsklötzen und Bremsbelägen
- Nullstellung in jeder Position
- 3 V (CR 2032)–240 mAh

Maximal 27 mm



Große LCD-Anzeige  
Umschaltung mm / Inch möglich

**25,05 €**  
zzgl. MwSt.



**V1423**, EAN 4047728014236

## Reifendrucktester

- Schnelle Überprüfung des Reifendrucks
- Klein und handlich
- Digitalanzeige
- Messbereiche:
  - 0,15 - 7 bar
  - 2 - 99,5 PSI
  - 15 - 70 KPA
- 3 V (CR 2032) - 240 mAh



Automatische Abschaltung nach 90 Sek.

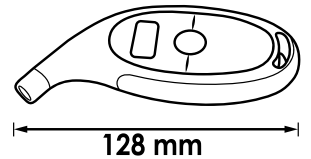

**18,05 €**  
zzgl. MwSt.

## Gummihammer

- Lösen festgerosteter Felgen beim Radwechsel



Kunststoff-Stiel

Rückschlagfrei durch Stahlkugeln

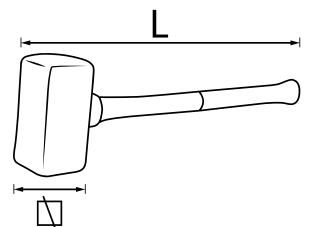

VIGOR No.	mm	kg	EAN 4047728+	€
V2235	50	2,5	022354	72,20
V2234	74	5	022347	115,50

**V1571**, EAN 4047728015714

## Lenkrad-Einstellwaage

- Ausrichtung des Lenkrades während der Achsvermessung sowie bei Arbeiten im Bereich der Lenksäule
- Schnelle Montage
- Einfache Justierung am Lenkrad
- Leicht ablesbar
- Universell einsetzbar für Pkw, Transporter und Lkw
- Durch Nutzung der Lenkrad-Einstellwaage können Lenkrad-Fehlstellungen vermieden werden
- Eine genaue Achsvermessung sollte stets durch geeichtes Achsvermessungsgerät durchgeführt werden

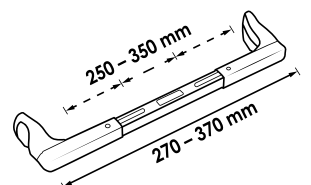

**78,05 €**  
zzgl. MwSt.

**V7181**, EAN 4047728071819

## Gewindeschneid Satz für Radschrauben und Radmuttern

- Beschädigte oder rostige Gewinde können falsche Drehmomentwerte verursachen
- Nachschneiden und Reinigen von Radschrauben und Radmuttern mit Innen- und Außengewinde
- Direkt am Fahrzeug anwendbar
- TiN-HSS beschichtete Oberfläche
- Im Kunststoffkoffer
- Geeignet für folgende Gewindegrößen:
  - M 12x1,25 mm
  - M 12x1,5 mm
  - M 14x1,5 mm



**Beschädigte oder rostige Gewinde können falsche Drehmomentwerte verursachen**

### Innengewinde



### Außengewinde

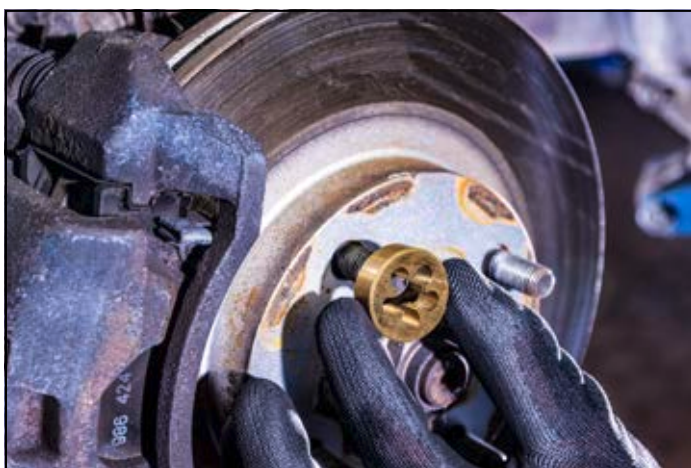

VIGOR No.	Bezeichnung	Ausführung	EAN 4047728+	€
V7181-1	Schneideisen · M 12x1,25 TiN		071840	23,90
V7181-2	Schneideisen · M 12x1,5 TiN		071833	23,90
V7181-3	Schneideisen · M 14x1,5mm TiN		071826	23,90
V7181-4	Handgewindebohrer · M 12x1,25 TiN		071864	29,90
V7181-5	Handgewindebohrer · M 12x1,5 TiN		071857	29,90
V7181-6	Handgewindebohrer · M 14x1,5 TiN		071871	29,90

**107,- €**  
zzgl. MwSt.



**V7001**, EAN 4047728075060

## Universal Felgenschloss-Demontage Satz

- Formbare Felgenschlüssel zum Lösen von nahezu allen Felgenschlössern
- Unter anderem auch für Felgenschlösser mit Kleeblatt-Profil
- Formbare Felgenschlüssel passen sich durch Hammerschlag an das Profil an
- Beidseitig verwendbar
- Mehrfachverformung einer Schlüsselseite nicht möglich
- Inhalt:
  - 8 Felgenschlüssel
  - 2 Adapter
  - Steckschlüsseleinsatz □ 12,5 mm (1/2") - SW 24 mm
  - Schlagkörper
  - Zentrierdorn
  - Handschutz-Polster



**287,50 €**  
zzgl. MwSt.



**V7001/4**, EAN 4047728075336

## Felgenschlüssel Satz

- Zweiseitig verwendbare Felgenschlüssel mit Ø 13 mm und 15 mm
- Für Universal Felgenschloss Demontage Satz V7001
- Material: AHSS (Kohlenstoffstahl)

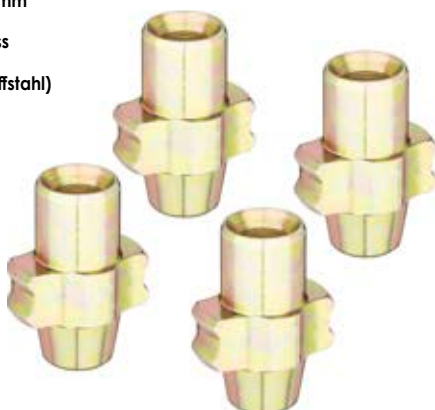

**37,80 €**  
zzgl. MwSt.

## Karosserie

Scheibenwischerarm-Abzieher Satz

308

Reparatur und Einbausätze

309

Induktionsheizgerät und Zubehör

310-314



**V2523**, EAN 4047728**025232**

## Scheibenwischerarm-Abzieher Satz

- Universell verwendbar
- Zum problemlosen Ausbau aller gängigen Wischerarme
- Optimale Einsatzmöglichkeiten bei gerosteten und festsitzenden Wischerarmen
- Größtmöglicher Schutz für integrierte Wischerdüsen bei Anwendung mit Schlagauszieher



VIGOR No.	Bezeichnung	Ausführung	EAN 4047728+	€
V4153	Abzieher · universal		041539	49,15
V4154	Schlagauszieher		041546	43,20
V4155	Druckspindel		041553	15,75
V4156	Spindelverlängerung		041560	7,80
V4157	Spindelvorsatz		041577	7,80
V4159	Zugglocke Nr. 1		041591	15,75
V4160	Zugglocke Nr. 2		041607	15,75
V4161	Zugglocke Nr. 3		041614	15,75
V4163	Zugglocke Nr. 5		041638	15,75
V4164	Zugglocke Nr. 6		041645	15,75
V4165	Zugglocke Nr. 7		041652	15,75
V4158	Zugglocke Nr. 8		041584	15,75



**204,- €**  
zzgl. MwSt.

**V3551N**, EAN 4047728075084

## Kunststoff-Reparatur Satz

- Reparatur und Verstärkung von Kunststoffteilen wie z.B. gerissene Lampenbügel und Gehäuse Teile
- Umfangreich und praktisch für Haushalt, Werkstatt oder Handwerk
- 3-in-1 Funktion mit auswechselbaren Aufsätzen
- Klammern aus rostfreiem Edelstahl
- Im Lieferumfang enthalten:
  - 50 Reparaturklammern Typ W / Ø 0,6 mm
  - 50 Reparaturklammern Typ W / Ø 0,8 mm
  - Je 5 Schweißstäbe, Material PE, PS, ABS
  - 10 Schweißstäbe, Material PP
  - 2 Verstärkungsgitter
- Leistung: 50 Watt
- Maximale Nutzungsdauer: 35 Min
- Ladezeit: 3,5 Stunden

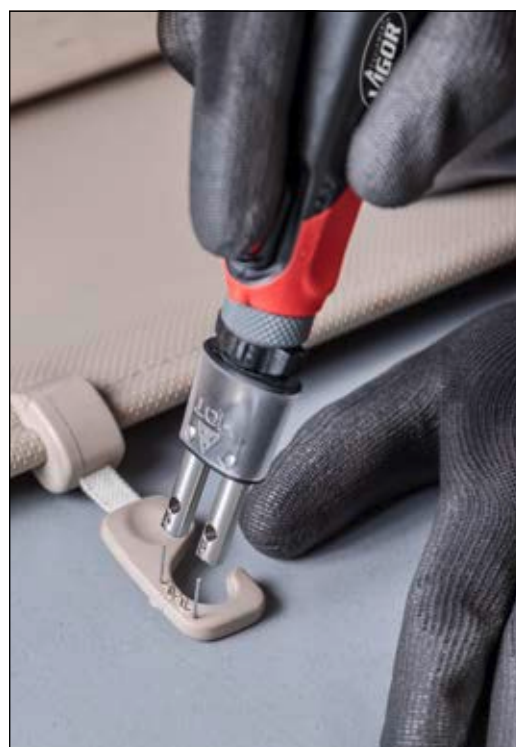

VIGOR No.	Bezeichnung	Ausführung		EAN 4047728+	€
V3670N	Ersatzklammern · 0,8 mm · V-Form		100	075671	16,10
V3671N	Ersatzklammern · 0,6 mm · V-Form		100	075688	16,10
V3672N	Ersatzklammern · 0,8 mm · W-Form		100	075695	16,10
V3673N	Ersatzklammern · 0,6 mm · W-Form		100	075701	16,10
V3676N	Ersatzklammern · 0,6 mm · U-Form		100	075718	16,10
V3677N	Ersatzklammern · 0,8 mm · U-Form		100	075725	16,10
V3551N-ABS	Kunststoff-Schweißstäbe Abs		10	077170	9,90
V3551N-PE	Kunststoff-Schweißstäbe Pe		10	077149	9,90
V3551N-PP	Kunststoff-Schweißstäbe Pp		10	077156	9,90
V3551N-PS	Kunststoff-Schweißstäbe Ps		10	077163	9,90
V3551N-W	Verstärkungsgitter		5	077132	9,90

**214,- €**  
zzgl. MwSt.



V4891-1.0, EAN 4047728080217

## Induktionsheizgerät

- Kompaktes Induktionsheizgerät zum flammenlosen Erhitzen von Bauteilen und Werkstücken
- Risikominimierung im Vergleich zu Acetylen Sauerstoff-Brennern
- LED am Spulenkopf zeigt Betrieb an
- Kompaktes Gerät im Verhältnis zur Ausgangsleistung von 1 kW
- Exakt platzierte Erwärmung innerhalb weniger Sekunden aufgrund modernster Mikroprozessor-Technologie
- Stromversorgung 230 V
- Satz bestehend aus:
  - V4891-1 (Starre Spule)
  - V4891-2 (Flexible Spule)
  - V4891-3 (Starre Spule)
  - V4891-4 (Flache Spule)

**NEU**



**550,- €**  
zzgl. MwSt.

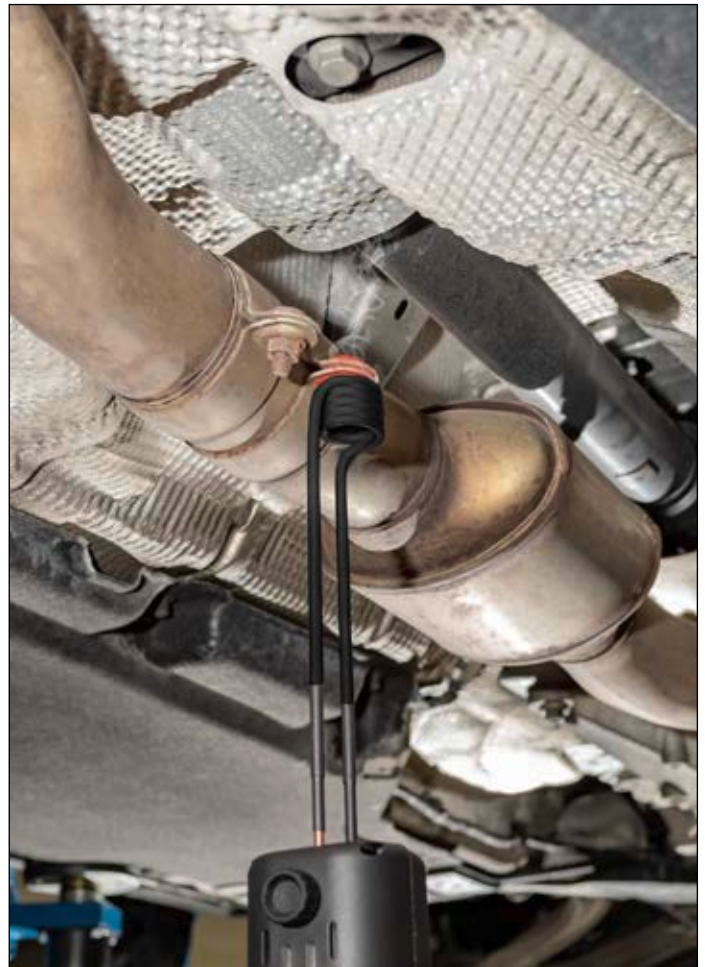



**V4891**, EAN 4047728**048910**

## Induktionsheizgerät

- Schnelles, einfaches Entfernen von Teilen an Fahrzeugen durch Erhitzung
- Durch umfangreiches serienmäßiges Zubehör vielseitig einsetzbar im Karosserie- und Nutzfahrzeugbereich
- Exakt platzierte Erwärmung innerhalb weniger Sekunden aufgrund modernster Mikroprozessor-Technologie
- Einfacher Transport durch Kunststoff-Koffer
- Vermeidung von Überhitzung bei gleichzeitig hohem Wirkungsgrad durch zwei Lüfter
- Anschlusskabel: 3 m
- Spulenschlauchlänge: 700 mm
- Gesteuerte Lüfterkühlung
- Starre Spulen: Erwärmung von Rohren, Bolzen, Profilen verschiedener Durchmesser
- Flexible Spule: zum Lösen von schwer zugänglichen Teilen durch den Einsatz von speziellem Wickeldraht
- Flachspule zur Erwärmung von Karosserie und Blech, vereinfacht das Abziehen von Aufklebern, Dichtstoffen etc.
- Robuste IGBT-Transistor-Technologie
- Kurzschluss- und Leerlaufest
- Automatische Anpassung an Resonanzfrequenz
- Frequenz: 25 kHz – 60 kHz
- 1,5 kW Leistung

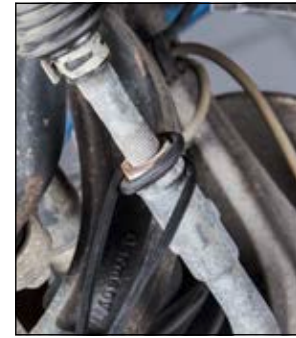

*Exakt platzierte Erwärmung  
innerhalb weniger Sekunden  
aufgrund modernster  
Mikroprozessor-Technologie*

*Inklusive 4 Spulen*

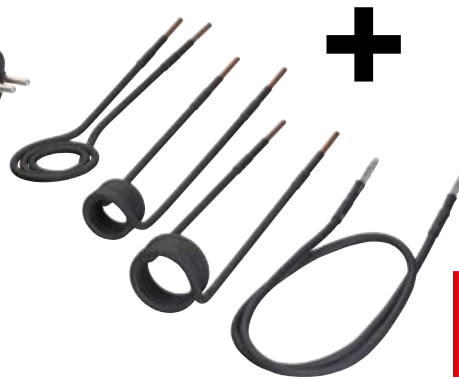

**999,- €**  
zzgl. MwSt.

**V4891-1**, EAN 4047728**049573**

### Starre Spule

- Gesamtlänge: 222 mm
- Vertikale Ausrichtung
- Innendurchmesser 19 mm, bis maximal M 8



**50,45 €**  
zzgl. MwSt.

**V4891-2**, EAN 4047728**049580**

### Flexible Spule

- Gesamtlänge: 750 mm
- Flexible Anwendung an individuellen Kfz-Bauteilen
- Für schwer-erreichbare Stellen



**76,85 €**  
zzgl. MwSt.

**V4891-3**, EAN 4047728**049597**

### Starre Spule

- Gesamtlänge: 225 mm
- Vertikale Ausrichtung
- Innendurchmesser 26 mm, bis maximal M 12



**80,35 €**  
zzgl. MwSt.

**V4891-4**, EAN 4047728**049603**

### Flach Spule

- Optimal für Flächenerwärmung
- Erwärmung flacher Schrauben
- Gesamtlänge: 227 mm
- Innendurchmesser 24 mm
- Außendurchmesser 45 mm



**56,50 €**  
zzgl. MwSt.



**V4891/6**, EAN 4047728062206

## Induktionsspulen Erweiterungssatz

- Satz bestehend aus:
  - V4891-5 (Fokus-Spule für punktuelle Erwärmung)
  - V4891-6 (Starre Spule)
  - V4891-7 (Starre Spule)
  - V4891-8 (Flexible Spule, Keramikschutz)
  - V4891-9 (Starre Spule)
  - V4891-10 (Starre Spule, seitlich)
- Kompatibel mit Induktionsheizgerät V4891 und V4891-1.0



**431,-€**  
zzgl. MwSt.

**V4891-5**, EAN 4047728062152

## Fokus-Spule · für punktuelle Erwärmung

- Erwärmen von Bauteilen, bei denen das Erreichen mit Standard-Spulen nicht möglich wäre
- Spule für punktgenaues Erhitzen, zur Konzentrierung der Energie
- Während der Erwärmung sollte ein Abstand von circa 2 – 4 mm zum Werkstück eingehalten werden, um Beschädigungen der Spule zu vermeiden
- Gesamtlänge: 210 mm



**94,35 €**  
zzgl. MwSt.

**V4891-6**, EAN 4047728062169

## Starre Spule

- Gesamtlänge: 220 mm
- Vertikale Ausrichtung
- Innendurchmesser 15 mm, bis maximal M 6



**50,45 €**  
zzgl. MwSt.

**V4891-7**, EAN 4047728062176

## Starre Spule

- Gesamtlänge: 240 mm
- Horizontale Ausrichtung
- Innendurchmesser 45 mm, bis maximal M 22

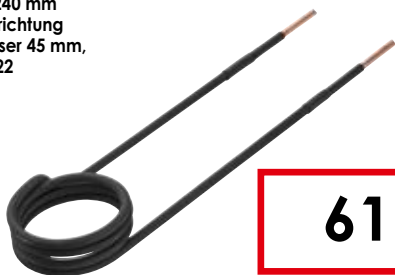

**61,85 €**  
zzgl. MwSt.

**V4891-8**, EAN 4047728062183

## Flexible Spule · Keramikschutz

- Gesamtlänge: 800 mm
- Höhere Temperaturbeständigkeit
- Die Keramikbeschichtung verlängert die Lebensdauer
- Selbsteinstellender Abstand bei kleineren Bauteilen



**127,-€**  
zzgl. MwSt.

**V4891-9**, EAN 4047728062190

## Starre Spule

- Gesamtlänge: 220 mm
- Vertikale Ausrichtung
- Innendurchmesser 45 mm, bis maximal M 22



**61,85 €**  
zzgl. MwSt.

**V4891-10**, EAN 4047728062343

## Starre Spule · seitlich

- Gesamtlänge: 230 mm
- Horizontale Ausrichtung
- Innendurchmesser 23 mm, bis maximal M 10



**68,60 €**  
zzgl. MwSt.

**V4891-3.5**, EAN 4047728072779

**Induktionsheizgerät · Lkw 3,5 KW**

- Starke 3,5 kW Variante für Kfz- sowie Nfz-Anwendungen
- Effiziente Methode der Erhitzung, ohne Beschädigung umliegender Bauteile
- Wassergekühlt
- Tragbar, trotz hoher Leistung
- Ausgabelistung exakt auf den Anwendungsbereich einstellbar
- Möglichkeit der Kraftausgabe in 10 – 100 % Schritten
- Auslieferungszustand inklusive Kühlmittel
- Punktgenaue Erhitzung von Bauteilen und Elementen
- Betriebshinweis durch LED am Spulenkopf
- Zusätzlicher Ventilator im Gehäuse sorgt für Überhitzungsschutz der Hardwarekomponenten
- Exakt platzierte Erwärmung innerhalb weniger Sekunden aufgrund modernster Mikroprozessor-Technologie



**3.299,- €**  
zzgl. MwSt.

**V4891-3.5-1**, EAN 4047728072786

**Erweiterungsspule · Radbolzen**

- Extra schmale Bauform ermöglicht punktuell Erhitzen von Radbolzen



**399,- €**  
zzgl. MwSt.

**V4891-3.5-2**, EAN 4047728072793

**Standardspule · seitlich**



**399,- €**  
zzgl. MwSt.

**V4891-3.5-3**, EAN 4047728072809

**Reduzierstück**

- Reduzierstück zur Adaption der Einsteckspule V4891-3.5-4



**173,50 €**  
zzgl. MwSt.

**V4891-3.5-4**, EAN 4047728072816

**Einsteckspule · 26 mm**

- Einsteckspule · 26 mm
- Nur in Verbindung mit V4891-3.5-3



**399,- €**  
zzgl. MwSt.

**V4891-3.5-6**, EAN 4047728072892

**Rundspule · 32 mm**



**399,- €**  
zzgl. MwSt.

**V4891-3.5-5**, EAN 4047728072823

**Kühlmittel · 3 l**



**46,45 €**  
zzgl. MwSt.



**V4891-10.0**, EAN 4047728077958

## Induktionsheizgerät

- Ultrastarke 10 kW Variante zum Erhitzen von massiven Bauteilen
- Mobiles Gerät mit Fahrwerk und integrierter Wasserkühlung
- Leiser Betrieb
- Effiziente Methode der Erhitzung, ohne Beschädigung umliegender Bauteile
- Risikominimierung im Vergleich zu Acetylen Sauerstoff-Brennern
- 10 Liter, wassergekühlt
- Kompaktes Gerät im Verhältnis zur Ausgangsleistung von 10 kW
- Ausgabeleistung exakt auf den Anwendungsbereich einstellbar
- Stufenlose Leistungsregelung von 10 bis 100 Prozent
- Auslieferungszustand inklusive Kühlmittel
- LED am Spulenkopf zeigt Betrieb an
- Exakt platzierte Erwärmung innerhalb weniger Sekunden aufgrund modernster Mikroprozessor-Technologie
- Stromversorgung 400 V · 32A



**8.500,- €**  
zzgl. MwSt.

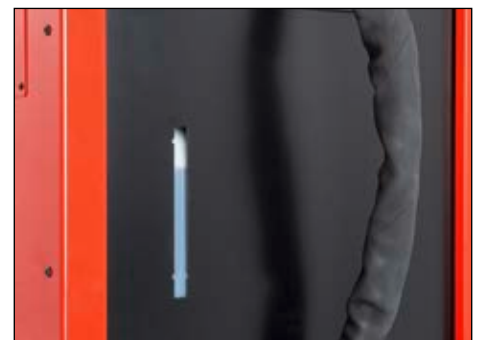

**V3863**, EAN 4047728**038638**

## Stoßdämpfer-Montagewerkzeug Satz

- Demontage / Montage an Stoßdämpfern mit Zuganschlagfeder
- Fixierung mittels Klemmstücken mit V-Form Kunststoffeinsätzen in Endanschlagposition ohne Beschädigung
- Für: BMW · FIAT · FORD · MERCEDES-BENZ · NISSAN · PEUGEOT · TOYOTA
- Inhalt:
  - Spezial-Grundkörper
  - Robuste M 12 Gewindespindel mit Spezialaufnahme
  - Universal Klemmstück mit V-Form-Kunststoffeinsätzen

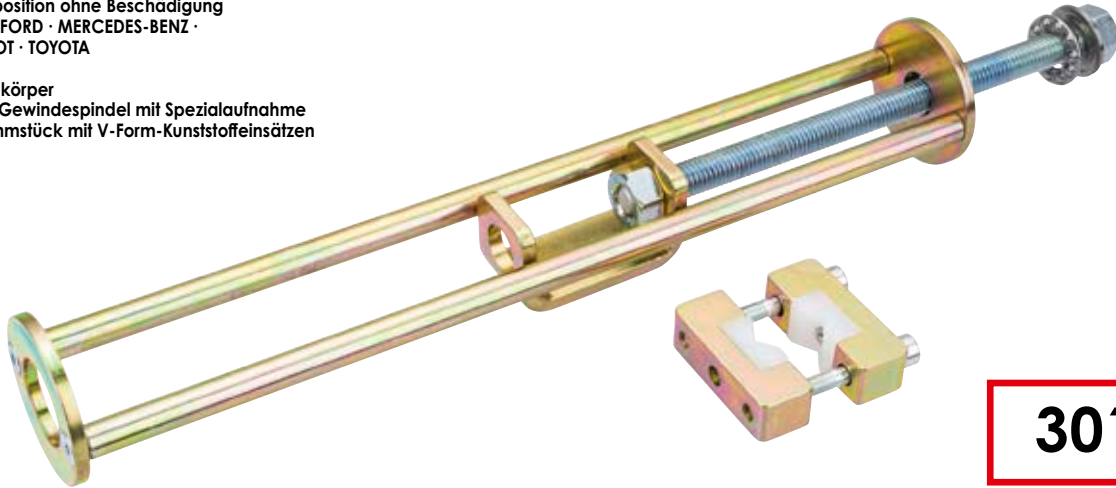

**301,50 €**  
zzgl. MwSt.



**V3661**, EAN 4047728**036610**

## Klemmstück mit Kunststoff-Schonbacken (universal)



**119,- €**  
zzgl. MwSt.

**V4126N**, EAN 4047728**078566**

## Klemmschrauben Demontage-Werkzeug Satz

- Befähigen der Klemmschraube an der VAG Mehrlenker-Achse im eingebauten Zustand
- Kein Pressen oder Ziehen am Aluminium-Achsschenkel
- Bohrführungen garantiert exaktes Ausbohren der Stahlschraube
- Inhalt:
  - 3 Hochleistungsbohrer (HSS Cobalt) Größe: 6 · 8,5 · 10 mm
  - 1 Andrückbügel
  - 1 Durchtreiber
- Für zum Beispiel:
  - AUDI A4 Bj. 2015 → · A5 Bj. 2016 → · A6 Bj. 2018 → · A7 Bj. 2017 → · Q5 Bj. 2016 → · Q7 Bj. 2015 → · Q8 Bj. 2018 → · E-Tron Bj. 2018 →
  - VW Touareg Bj. 2017 →



**599,- €**  
zzgl. MwSt.

VIGOR No.	∅	EAN 4047728+	€
V4248	6	042482	37,40
V4249	8.5	042499	57,65
V4250	10	042505	37,40



**V6452**, EAN 4047728**064521**

## Stoßdämpfer-Werkzeug Satz

- Fachgerechte Instandsetzungsarbeiten am Federbein (Gegenhalten der Kolbenstange beim Aus- und Einbau)
- Betätigung Stoßdämpfer-Mutter am Domlager
- Für die gängigsten Fahrzeugtypen

- Inhalt:
  - Offene Umschaltknarre, SW 21 mm, Zwölfkant
  - Offene Sechskant-Einsätze:
    - 12,5 mm (1/2"), SW 16 · 17 · 18 · 19 · 21 · 22 · 24 mm
    - 12,5 mm (1/2") Schraubendreher Einsatz, SW 6 · 7 · 8 mm
    - 12,5 mm (1/2") Verlängerung: 250 mm
    - 12,5 mm (1/2") Steckschlüssel-Einsätze, oval 5 x 8 mm, 6 x 8 mm



VIGOR No.	Bezeichnung	Ausführung	EAN 4047728+	€
V6452-1	Umschaltknarre · offen		075220	52,85
V6452-5	Steckschlüsseinsatz Sonderprofil · MERCEDES-BENZ · 5 mm		075206	21,50
V6452-6	Steckschlüsseinsatz Sonderprofil · MERCEDES-BENZ · 6 mm		075213	21,50
V6452-16	Steckschlüsseinsatz · 16 mm		075091	7,45
V6452-17	Steckschlüsseinsatz · 17 mm		075107	7,80
V6452-18	Steckschlüsseinsatz · 18 mm		075114	8,-
V6452-19	Steckschlüsseinsatz · 19 mm		075121	8,45
V6452-21	Steckschlüsseinsatz · 21 mm		075138	8,90
V6452-22	Steckschlüsseinsatz · 22 mm		075145	9,65
V6452-24	Steckschlüsseinsatz · 24 mm		075152	10,70
V6452-250	Gleitgriff · 250 mm		075169	15,05
V6452-H6	Steckschlüsseinsatz Sechskant · 6 mm		075176	13,95
V6452-H7	Steckschlüsseinsatz Sechskant · 7 mm		075183	13,95
V6452-H8	Steckschlüsseinsatz Sechskant · 8 mm		075190	13,95



**200,50 €**  
zzgl. MwSt.

**V6956**, EAN 4047728**069564**

## Universal Achshebel

- Fachgerechte, schonende Demontage und Montage von Achsteilen, wie z.B. Kugelgelenken und Querlenkern
- Kettenverstellung ermöglicht flexiblen Einsatz und Anpassung auf verschiedene Abmaße und Gegebenheiten
- Verwendete Spindel in hoher Güte gewährleistet kraftsparendes Arbeiten und hohe Kraftübertragung
- Direkte Verwendung am Fahrzeug ohne Hinzunahme einer zweiten Person
- Gummiisolierte Stützfläche gewährleistet sicheren Halt am Fahrzeug
- Zur Befügung mit Umschaltknarre oder Lufratsche

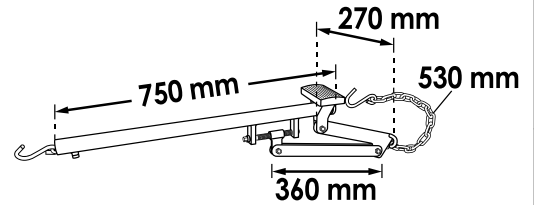

**306,- €**  
zzgl. MwSt.

**V4642**, EAN 4047728**046428**

## Gelenkwellen-Abzieher · universal

- Fachgerechte Demontage des Gleichlaufgelenkes sowie der Gummimanschetten der Antriebswelle
- Extrabreiter Rahmen, auch für große Gelenke

Speziell geformte Spannbacken garantieren sicheren Halt der Antriebswelle

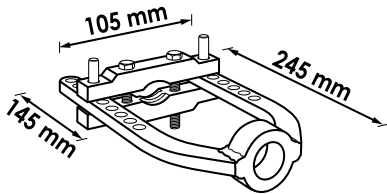

max. Ø 31.5 mm



**125,- €**  
zzgl. MwSt.



**V7525**, EAN 4047728075251

## Universal Pressunterlage

- Demontage und Montage von Lagern und Buchsen in Verbindung mit Werkstattpressen
- Optimierte Dreipunkt-Ausrichtung von Werkstücken an der Werkstattpresse
- Durch umfangreiche Verstellbarkeit sind nahezu alle Werkstücke parallel zur Werkstattpresse ausrichtbar, um die Sicherheit bei der Anwendung zu erhöhen
- Seitlicher Anschlag für sicheren Halt auf der Werkstattpresse
- Schwenkunterlage ermöglicht die schnelle und einfache Positionierung auf der Unterlage
- Maximal zugelassene Belastbarkeit: 20 Tonnen

**MADE IN GERMANY**



**431,- €**  
zzgl. MwSt.





**V4636N**, EAN 4047728078719

## Lager-Innenring Abzieher

- Für Lager-Innenringe, die direkt an der Radnabe liegen
- Für Ringe im Spannungsbereich 33 – 60 mm
- Auswechselbare Kegel mit  $\varnothing$  32 mm und  $\varnothing$  40 mm für umfangreiche Marktabdeckung
- Auch geeignet für Modelle mit ABS-Küfig, z.B. VW Golf 4
- Feststellschraube verhindert Abrutschen der Arme
- Betätigung mit Umschaltknarre



**299,- €**  
zzgl. MwSt.

### Im Lieferumfang enthalten

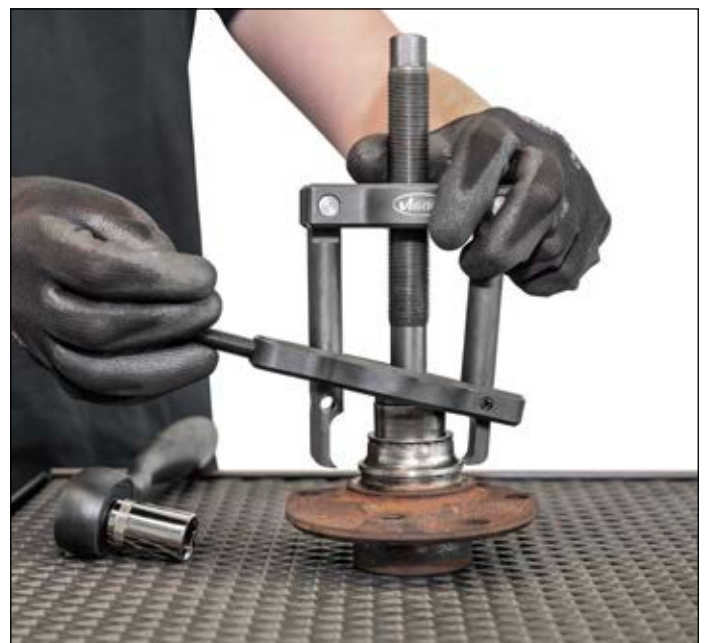
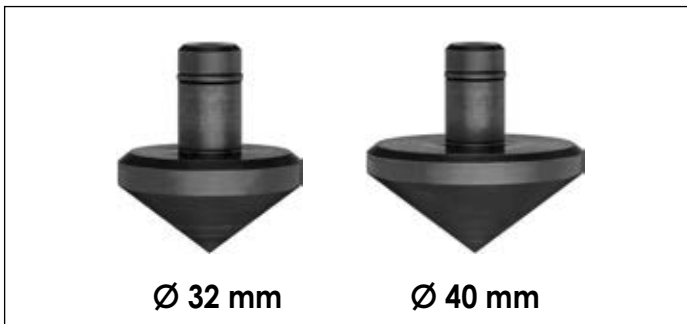

**DEIN  
FAHRWERK  
SPEZIALIST**

IN SACHEN WERKZEUG

## Kfz / Nfz Fahrwerk Spezial-Werkzeug

Druck- und Zugzylinder	322–324
Hydraulik-Pumpen	325
Zubehör Zylinder	326–329
Mechanischer Antrieb	330
Werkzeugsätze Standard-Radlager	331–334
Werkzeugsätze Kompakt-Radlager	335
Werkzeugsätze geschraubte Kompakt-Radlager	336–345
Werkzeugsätze Radnabe mit 6- und 8- Bolzen	344
Werkzeugsätze Antriebswellen	345
Multiboxen	346–363
Werkzeugsätze Lager und Buchsen	366–375
Federspanner	376–379
Mobile Werkbänke mit Spezialwerkzeug Sortiment	380–388
Spezial Weichschaum-Einlagen	389–395
Werkzeugsätze Nfz	396–415

**V2873**, EAN 4047728028738

## Druck- und Zug-Hydraulikzylinder 8,5 Tonnen

- Auspressen von Traggelenken und Buchsen
- Einsetzbar auf engstem Raum
- Druckstange verstellbar

### Automatischer Kolbenrücklauf



**582,50 €**  
zzgl. MwSt.



VIGOR No.	Bezeichnung	Ausführung	L mm	EAN 4047728+	€
V3012	CEJN-Nippel Hydraulik · 1/8 Zoll		-	030120	78,50
V3009	Hydraulik-Zylinder · 8,5 Tonnen		-	030090	595,50
V3011	Druckstange - verstellbar M 22		100	030113	81,-
V3010	Schlagkörper mit O-Ring		-	030106	67,20

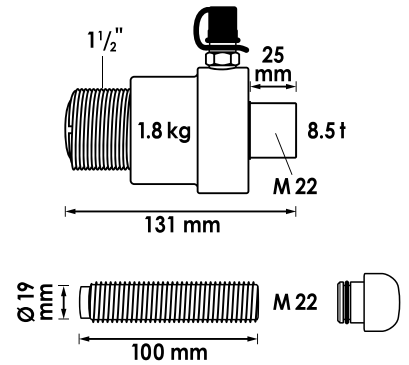

**V2869**, EAN 4047728028691

## Druck-Hydraulikzylinder 14 Tonnen

- Auspressen von Traggelenken und Buchsen
- Speziell für Einsatz mit Pressbügel V2885 und V2858N

### Automatischer Kolbenrücklauf



**519,- €**  
zzgl. MwSt.

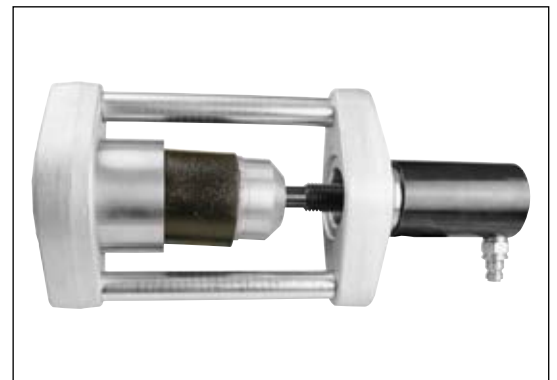

VIGOR No.	Bezeichnung	Ausführung	L mm	EAN 4047728+	€
V3128	(CEJN-) Nippel Hydraulik 1/4"		-	031288	97,90
V3217	Hydraulik-Zylinder · 14 Tonnen		-	032179	513,-
V3124	Druckstange - verstellbar M 24		92	031240	86,05

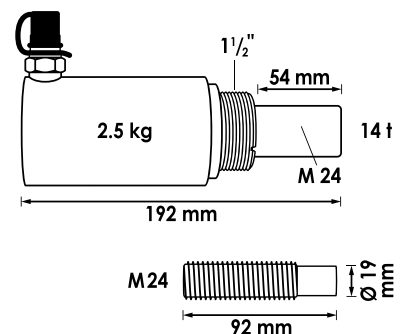

# Druck- und Zugzylinder



**V4551**, EAN 4047728**045513**

**Druck- und Zug-Hydraulikzylinder 18 Tonnen**

**Automatischer Kolbenrücklauf**



- Ausdrücken von festgerosteten Antriebswellen
- Druck des Hydraulikzylinders kann bei Verwendung eines Schlagkörpers mit Schlagkraft kombiniert werden
- Einsatz mit allen Pkw-Werkzeugen und Zugstangen M 10 – M 22 mit entsprechender Reduzierung

**986,50 €**  
zzgl. MwSt.



VIGOR No.	Bezeichnung	Ausführung	L mm	EAN 4047728+	€
V3128	(CEJN-) Nippel Hydraulik 1/4"		-	031288	97,90
V4552	Hydraulik-Zylinder · 18 Tonnen · ohne Zubehör		-	045520	765,50
V3125	Schutzring für Gewinde 1.1/2"		-	031257	47,95
V3127	Zugstange · M 18 – M 22 · maximal 22 t		250	031271	79,90
V3123	Druckfuß M 24x3 mm		-	031233	33,45
V3124	Druckstange · verstellbar M 24		92	031240	86,05
V4553	Druckachse · M 24x3 mm		-	045537	112,-
V3126	Kragenmutter · M 18x2,5		-	031264	47,95
V3018	Schlagkörper · M 22x2,5 mm		-	030182	101,50
V3129	Druckstück · verstellbar M 24		132	031295	86,95

**Extra leicht:  
Nur 2,8 kg**

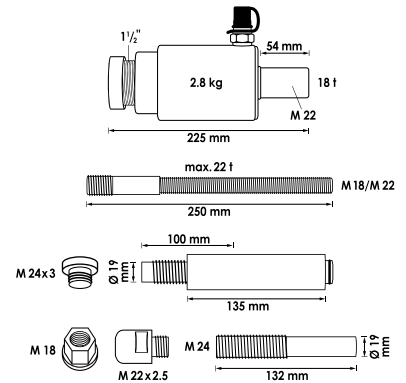

**V2854**, EAN 4047728**028547**

**Druck- und Zug-Hydraulikzylinder 22 Tonnen**

**Automatischer Kolbenrücklauf**



- Ausdrücken von festgerosteten Antriebswellen
- Druck des Hydraulikzylinders kann bei Verwendung eines Schlagkörpers mit Schlagkraft kombiniert werden
- Einsatz mit allen Pkw-Werkzeugen und Zugstangen M 10 – M 22 mit entsprechender Reduzierung

**1.011,50 €**  
zzgl. MwSt.



VIGOR No.	Bezeichnung	Ausführung	L mm	EAN 4047728+	€
V3128	(CEJN-) Nippel Hydraulik 1/4"		-	031288	97,90
V3199	Hydraulik-Zylinder · 22 Tonnen		-	031998	854,50
V3125	Schutzring für Gewinde 1.1/2"		-	031257	47,95
V3127	Zugstange · M 18 – M 22 · maximal 22 t		250	031271	79,90
V3126	Kragenmutter · M 18x2,5		-	031264	47,95
V3124	Druckstange · verstellbar M 24		92	031240	86,05
V3134	Druckachse M 24x3 mm		151	031349	91,50
V3123	Druckfuß M 24x3 mm		-	031233	33,45
V3018	Schlagkörper · M 22x2,5 mm		-	030182	101,50
V3130	Druckstück · verstellbar M 24		109	031301	86,95

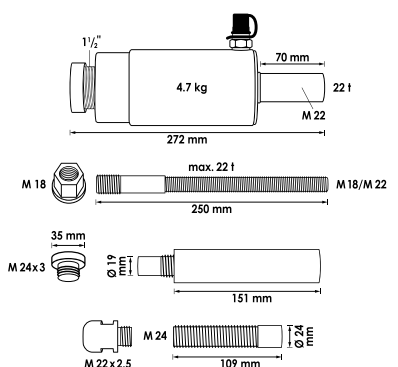

**V2874**, EAN 4047728**028745**

## Druck- und Zug-Hydraulikzylinder 32 Tonnen

- Ausdrücken von festgerosteten Antriebswellen und Achsschenkelbolzen
- Druck des Hydraulikzylinders kann bei Verwendung eines Schlagkörpers mit Schlagkraft kombiniert werden
- Einsatz mit allen Pkw-Werkzeugen und Zugstangen M 10 – M 22 mit entsprechender Reduzierung

Automatischer Kolbenrücklauf



**1.302,- €**  
zzgl. MwSt.

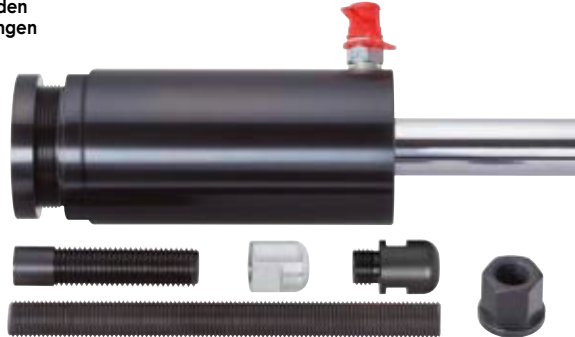

VIGOR No.	Bezeichnung	Ausführung	L mm	EAN 4047728+	€
V3128	(CEJN-) Nippel Hydraulik 1/4"		-	031288	97,90
V3216	Hydraulik-Zylinder · 32 Tonnen		-	032162	1.150,-
V3131	Schutzring für Gewinde 2,5		-	031318	67,55
V3130	Druckstück · verstellbar M 24		109	031301	86,95
V3092	Schlagmutter		-	030922	100,50
V3018	Schlagkörper · M 22x2,5 mm		-	030182	101,50
V3133	Zugstange · M 22 · maximal 32 t		250	031332	71,15
V3132	Kragenmutter · M 22x2,5		-	031325	65,30

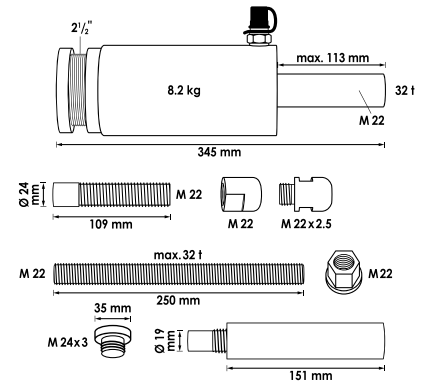

**V4229**, EAN 4047728**042291**

## Druck- und Zug-Hydraulikzylinder 45 Tonnen

- Ausdrücken von festgerosteten Antriebswellen
- Druck des Hydraulikzylinders kann bei Verwendung eines Schlagkörpers mit Schlagkraft kombiniert werden

Automatischer Kolbenrücklauf



**1.960,- €**  
zzgl. MwSt.

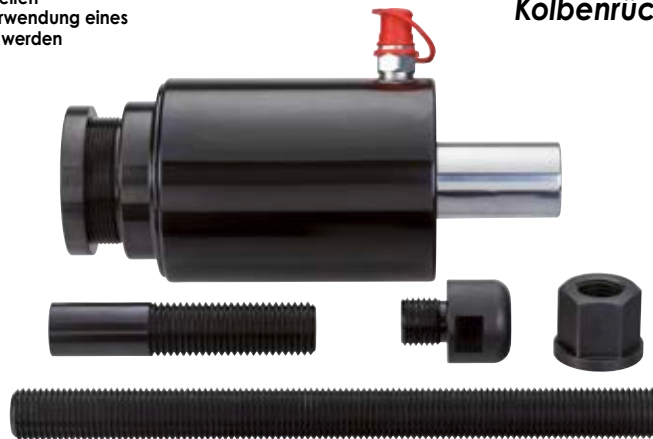

VIGOR No.	Bezeichnung	Ausführung	L mm	EAN 4047728+	€
V3128	(CEJN-) Nippel Hydraulik 1/4"		-	031288	97,90
V4242	Hydraulik-Zylinder 45 Tonnen		-	042420	1.795,50
V3131	Schutzring für Gewinde 2,5		-	031318	67,55
V4251	Druckstück · verstellbar · M 30		145	042512	180,50
V4254	Schlagkörper · M 27		-	042543	132,50
V4252	Kragenmutter M 27		-	042529	138,50
V4253	Zugstange · M 27 · maximal 50 t		330	042536	138,50

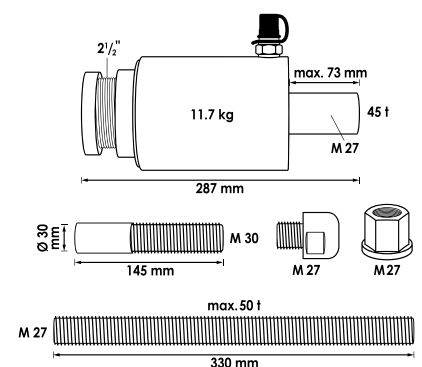



**V2846**, EAN 4047728028462

## Hydraulikpumpe · pneumatisch

- Für alle Hydraulikzylinder
- Inklusive Öl-Messstab



**Ausführung inklusive Manometer**

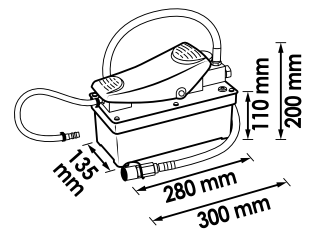

**925,- €**  
zzgl. MwSt.



VIGOR No.	Bezeichnung	Ausführung	EAN 4047728+	€
V3120	2,2 m Hydraulikschlauch 1/4"		031202	216,50
V3141	(CEJN-) Schnellkupplung		031417	158,50
V4255	Manometer		042550	96,15

**V2847**, EAN 4047728028479

## Hydraulische Fußpumpe

- Für alle Hydraulikzylinder

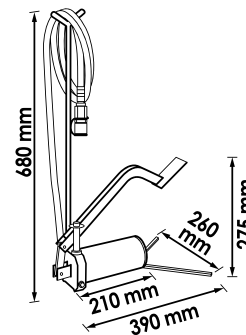
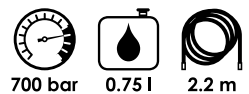

**665,50 €**  
zzgl. MwSt.



VIGOR No.	Bezeichnung	Ausführung	EAN 4047728+	€
V3120	2,2 m Hydraulikschlauch 1/4"		031202	216,50
V3614	Dichtungssatz		036146	52,40
V3141	(CEJN-) Schnellkupplung		031417	158,50

**V2800-OEL**, EAN 4047728081276

## Hydrauliköl Power

- Hoher Viskositätsindex (VI), speziell für Hydrauliksysteme in mobilen Geräten und im Außenbereich
- Erfüllt die nachfolgenden Spezifikationen und Anforderungen: DIN 51524 Part 2 HLP · HVLP · -ISO 11158HV – AFNOR NFE 48-603
- Speziell für alle Hydraulikzylinder und Pumpen geeignet
- Pumpen: V2846 · V2847
- Hydraulikzylinder: V2873 · V2869 · V4551 · V2854 · V2874 · V4229 · V5916 · V5916-XL



**NEU**

**31,70 €**  
zzgl. MwSt.

**V4218**, EAN 4047728042185

## Halteungs Satz für Hydraulik-Zylinder

- Verwendung als Handhalter oder mit Getriebeheber
- Für alle handelsüblichen Getriebeheber mit Ø von 25 und 30 mm
- Für Hydraulikzylinder V2869 (14 Tonnen) · V2855 (16 Tonnen) · V4551 (18 Tonnen) · V2854 (22 Tonnen) · V2874 (32 Tonnen)
- Auch für Hydraulikzylinder mit 65 – 100 mm Ø (z.B. Paschke, Klann)
- Problemloses Justieren und Fixieren des Hydraulikzylinders ermöglicht flexible und schnelle Handhabung bei der Arbeit direkt am Fahrzeug



Lieferung ohne Hydraulikzylinder



**260,- €**  
zzgl. MwSt.

VIGOR No.	Bezeichnung	Ausführung	EAN 4047728+	€
V4244	Schelle Ø 70 mm		042444	21,10
V4245	Schelle Ø 85 mm		042451	21,10
V4246	Schelle Ø 100 mm		042468	21,10
V4243	Halterung ohne Schelle		042437	249,50

**V2850**, EAN 4047728028509

## Adapter

- Adaptierung des Klann Hydraulikzylinders mit 17 Tonnen auf das VIGOR-Spezialwerkzeug
- Adapter 2.1/4" – 14 UNS (Klann-Gewinde) auf 1.1/2"



**126,50 €**  
zzgl. MwSt.



**V2851**, EAN 4047728**028516**

## Adapter

- Adaptierung des VIGOR Hydraulikzylinders (8,5 Tonnen bis 22 Tonnen) auf das KLANN Spezialwerkzeug
- Adapter 2.1/4" - 14 UNS (Klann-Gewinde) auf 1.1/2"

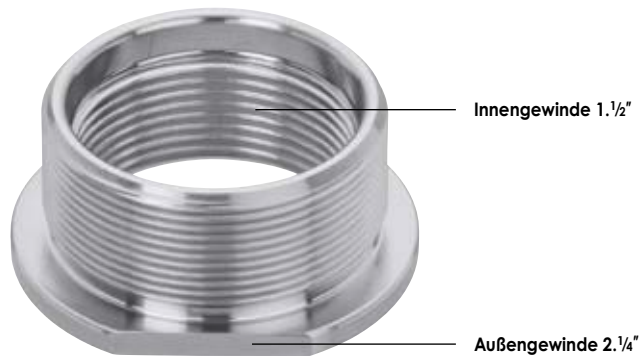

**118,50 €**  
zzgl. MwSt.

**V2910**, EAN 4047728**029100**

## Adapter

- Adaptierung der Hydraulikzylinder 16 Tonnen (V2855) und 22 Tonnen (V2854) auf das VIGOR Spezialwerkzeug mit 1.1/2" Gewinde
- Adapter 1.1/2" auf 2.1/2" - 11 UNS

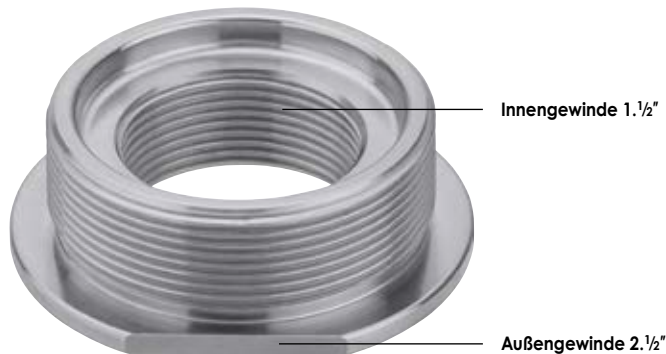

**118,50 €**  
zzgl. MwSt.

**V3869**, EAN 4047728**038690**

## Adapter

- Adaptierung des VIGOR Hydraulikzylinders auf das Paschke Spezialwerkzeug
- Adapter M 68 x 2 mm (Paschke-Gewinde) auf 1.1/2"

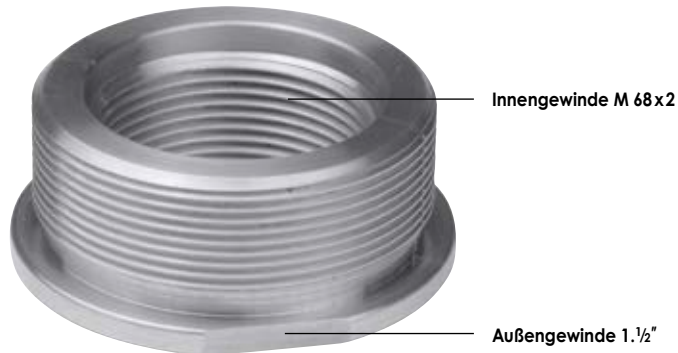

**117,- €**  
zzgl. MwSt.

**V3870**, EAN 4047728**038706**

## Adapter

- Adaptierung des Paschke Hydraulikzylinders auf die VIGOR-Spezialwerkzeuge
- Adapter M 68 x 2 mm (Paschke-Gewinde) auf 1.1/2" - 11

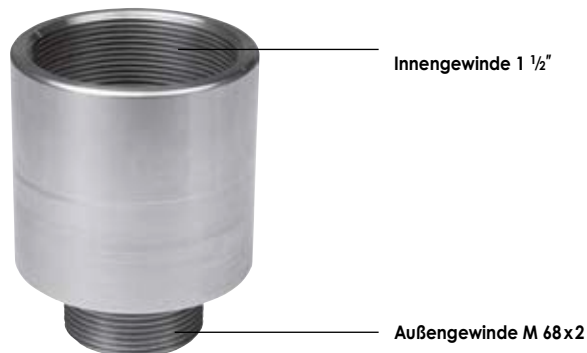

**127,- €**  
zzgl. MwSt.

**V4220**, EAN 4047728**042208**

## Adapter

- Adaptierung des Klann Hydraulikzylinders mit 28 Tonnen auf das VIGOR-Spezialwerkzeug
- Adapter 2.3/4" - 14 UNS (Klann-Gewinde) auf 2.1/2"

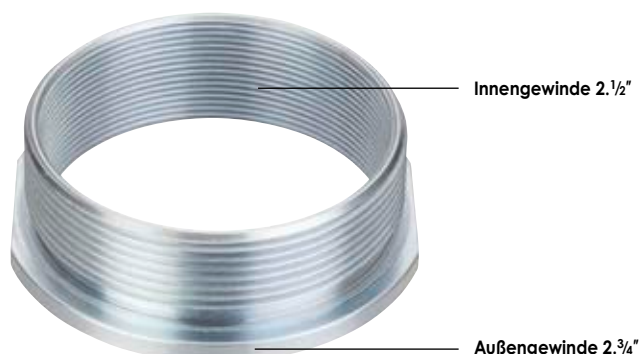

**117,- €**  
zzgl. MwSt.



**V3207**, EAN 4047728**032070**  
Zugstangen-, Kragenmutter  
Adapter Satz



VIGOR No.	Bezeichnung	Ausführung	l mm	EAN 4047728+	€
V3210	Zugstange · M 10 · maximal 6 t		150	032100	43,75
V3220	Zugstange · M 12 · maximal 9 t		250	032209	43,75
V3136	Zugstange · M 14 · maximal 12 t		250	031363	56,85
V3127	Zugstange · M 18 – M 22 · maximal 22 t		250	031271	79,90
V3133	Zugstange · M 22 · maximal 32 t		250	031332	71,15
V3209	Adapter · M 22x2,5 – M 10x1,5		-	032094	43,75
V3219	Adapter · M 22x2,5 – M 12x1,75		-	032193	43,75
V3135	Adapter · M 22x2,5 – M 14x2,0		-	031356	43,50
V3275	Kragenmutter · M 10x1,5		-	032759	22,25
V3208	Kragenmutter · M 12x1,75		-	032087	38,10
V3137	Kragenmutter · M 14x2,0		-	031370	43,50
V3126	Kragenmutter · M 18x2,5		-	031264	47,95
V3132	Kragenmutter · M 22x2,5		-	031325	65,30

**578,- €**  
zzgl. MwSt.

VIGOR No.	Bezeichnung	Ausführung	EAN 4047728+	€
V4596*	Adapter · M 18 – M 22		045964	90,65
V4597*	Adapter · Innengewinde: M 22x2,5 mm · Außengewinde: M 27x3,0 mm		045971	71,40
V4342*	Schlagmutter · M 18		043427	101,50

\* Nicht im Satz enthalten

**V7699**, EAN 4047728**076999**  
Spindel M22 · M20



VIGOR No.	l mm	EAN 4047728+	€
V7699	300	076999	147,50

**V7700**, EAN 4047728**077002**  
Kragenmutter M20



VIGOR No.	EAN 4047728+	€
V7700	077002	37,10

**V3582**, EAN 4047728035828

## Einklemmschutz

- Schutz beim Arbeiten mit Hydraulikzylindern in Verbindung mit Spezialwerkzeugen



**277,50 €**  
zzgl. MwSt.

**V3612**, EAN 4047728036122

## Manometer

- Anschlussstück und Nippel zur direkten Ankopplung an allen hydraulischen Pumpen von VIGOR
- Angaben des maximalen Druckbereichs der Hydraulikzylinder finden Sie in der jeweiligen Betriebsanleitung



**361,- €**  
zzgl. MwSt.

**V6592**, EAN 4047728065924

## Adapter 3/8" Innengewinde · auf CEJN / Pumpe

- Adaptieren von z.B. Klann oder Sauer Hydraulikpumpen auf den CEJN-Anschluss
- Schnelle, einfache Verbindungsart
- Tropffrei, ohne Ölverlust
- Schützt vor Eindringen von Luft in das System
- CEJN Anschlüsse sind kleiner als herkömmliche Verbindungen – für beengte Platzverhältnisse
- Flexibel, leichte Arretierungen sind ohne Verspannungen möglich

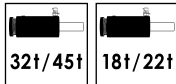

**62,15 €**  
zzgl. MwSt.

**V6591**, EAN 4047728065917

## Adapter 3/8" Außengewinde · auf CEJN / Zylinder

- Adaptieren von z.B. Klann oder Sauer Hydraulikzylinder auf den CEJN-Anschluss
- Schnelle, einfache Verbindungsart
- Tropffrei, ohne Ölverlust
- Schützt vor Eindringen von Luft in das System
- CEJN Anschlüsse sind kleiner als herkömmliche Verbindungen – für beengte Platzverhältnisse
- Flexibel, leichte Arretierungen sind ohne Verspannungen möglich

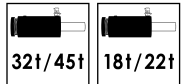

**62,15 €**  
zzgl. MwSt.



## V2853, EAN 4047728028530

### Spindel Satz · mechanisch

- Mechanische Spindel für Werkzeug-Sätze · V2865 · V2845 · V2848 · V2860 · V2870 · V4491 · V4629 · V2860 · V3731 und V3732
- 330 mm Länge ist ausreichend für fast alle auszuführenden Arbeiten

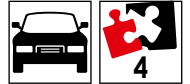

**272,- €**  
zzgl. MwSt.

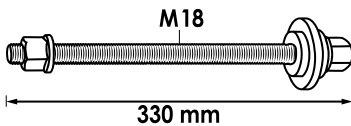

VIGOR No.	Bezeichnung	Ausführung	l mm	EAN 4047728+	€
V3126	Kragennutter · M 18x2,5		-	031264	47,95
V3008	Zugstange mit Kragennutter M 18		330	030083	138,50
V3206	Unterlegscheibe		-	032063	20,25
V3205	Druckscheibe		-	032056	114,-



## V4699, EAN 4047728046992

### Druckspindel Satz · manuell

- Manueller Druckspindel Satz zur mechanischen Betätigung von Spezialwerkzeugen
- Im Satz enthalten sind vier verschiedenen lange Druckstangen, mit denen der Gebrauch von unterschiedlichen Werkzeugen gewährleistet wird
- Verwendung mit V3072 · V2858N · V3147 · V3649 · V3148 · V2885 · V2920 und V2937
- Spindel und Adapter sind extra für die pneumatisch unterstützte Betätigung ausgelegt, sodass das Arbeiten mit einem Schlagschrauber bis maximal 1000 Nm Anzugsmoment möglich ist
- Effektive Kraftübertragung der Spindel liegt bei maximal 15 Tonnen
- Bei häufigen Arbeiten mit Traggelenken, Buchsen sowie Antriebswellen empfehlen wir die Verwendung des Hydraulikzylinders 8,5 – 22 Tonnen



**392,50 €**  
zzgl. MwSt.

VIGOR No.	Bezeichnung	Ausführung	EAN 4047728+	€
V4699-3	Scheibe Ø 18,8x3 mm (4 Stk.)		047029	62,90*
V4699-4	Press-Achse · 50xØ 19 mm		047036	40,70
V4699-5	Press-Achse · 85xØ 19 mm		047043	40,70
V4699-6	Press-Achse · 56xØ 24 mm		047050	40,70
V4699-7	Press-Achse · 100xØ 24 mm		047067	54,85
V4699-1	Druckspindel · M 30		047005	194,-
V4699-2	Adapter · 1. 1/2" · M 30		047012	83,45

\* Preis pro Satz



**V2867N**, EAN 4047728077859

## Sicherungsring-Werkzeug

- Erleichtert Ausbau von häufig fest gerosteten innenseitigen Sicherungsringen an Radlagern
- Aussparungen an Stellschraube für 6,3 mm (1/4") Ratsche für maximale Kraft und schnellen Ausbau
- Für Pkw, Transporter und Lkw
- Einzigartige Konstruktion ermöglicht unabhängig von Sicherungsring-Größe stets den richtigen Winkel des Stifts
- Einfacher, schneller Wechsel der Stifte
- Spitzen auch seitlich zu positionieren
- Optimierte Bauform für schwer zugängliche Bereiche



5 – 95 mm Spannbereich



**190,- €**  
zzgl. MwSt.

### Ersatzstifte für V2867N

VIGOR No.	Bezeichnung	EAN 4047728+	€
V2992	Stift Ø 2,5 mm	029926	36,70
V2993	Stift Ø 3,0 mm	029933	36,70
V2994	Stift Ø 3,5 mm	029940	36,70

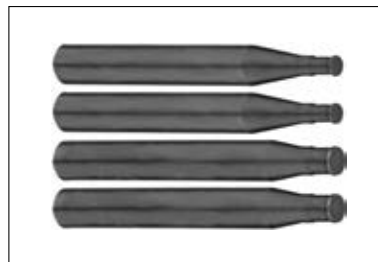

**V4629**, EAN 4047728046299

## Radnaben Demontage-Werkzeug · universal

- Effektive Methode zur Demontage von Radnaben.
- Empfehlung: Verwendung Radlager Satz V4598
- Funktion auch bei Achsschenkeln mit unebenen und begrenzten Flächen
- Deutliche Zeitersparnis zu bisherigen Systemen

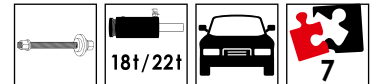

VIGOR No.	Bezeichnung	Ausführung	EAN 4047728+	€
V3873	Fixierschraube · M 14		038737	83,75*
V3874	Schraube · M 12		038744	26,30*
V3871	Traverse für diverse Druckfüsse		038713	268,50
V4629-1	Druckfuß Satz für V4629		046305	392,50**

**594,- €**  
zzgl. MwSt.

\* Preis pro Stück \*\* Preis pro Satz



**V4598**, EAN 4047728**045988**

## Radlager-, Antriebsachsen und Radnaben Satz · universal

- Wechseln des Radlagers direkt am Fahrzeug bei minimalem Zeitaufwand
- In Verbindung mit Hydraulikzylinder oder manueller Spindel
- Alle Teile sind für die heute auf dem Markt befindlichen Radlagergrößen angepasst
- Die Montagescheiben haben eine Führung und sind zweiseitig verwendbar
- Montagescheiben mit  $\varnothing 62 - 83$  mm und Nabenscheiben  $34 - 60$  mm sind enthalten, die Lagerschale ist für Radlager bis  $92$  mm  $\varnothing$
- Demontage der Radnabe mit V4629 · V2849 und V3072
- Arbeitszeit: circa 20 – 30 Minuten je Seite
- Radeinstellung oder Bremsanlagen-Entlüftung nicht erforderlich
- Kein Ausbau von ABS-Geber, Achsschenkel, Federbein oder Spurstangengelenk

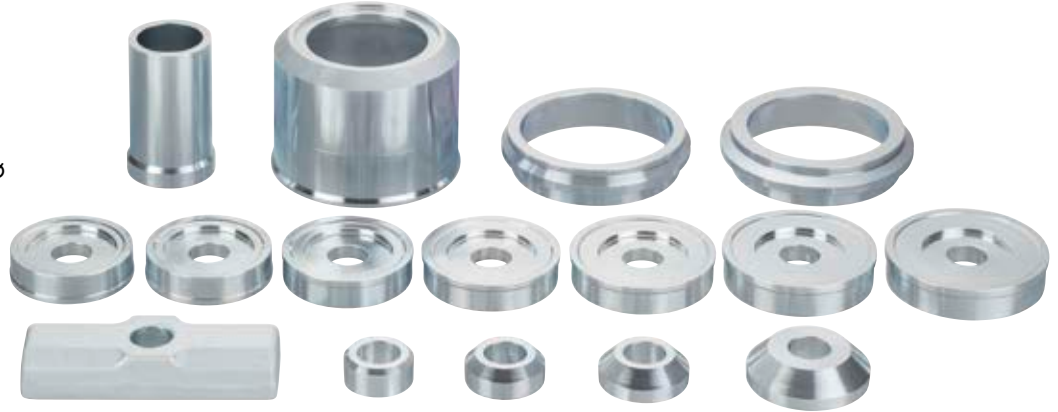

VIGOR No.	Bezeichnung	Ausführung	mm	EAN 4047728+	€
V4598-30	Druckrohr Länge 78 mm für V4598 · V4599		78	046282	67,45
V4598-22	Lagerschale $\varnothing 93$ mm für V4598		-	046275	67,45
V4598-21	Lagerschale $\varnothing 75,5$ mm für V4598		-	046268	67,45
V4598-20	Lagerschale $\varnothing 93$ mm für V4598		-	046251	130,-
V4598-10	Lagerscheibe $\varnothing 61,8 - 62,8$ mm · Innenloch- $\varnothing 20,25$ mm · passend für Spindel M 20		-	046183	75,45
V4598-11	Lagerscheibe $\varnothing 63,8 - 64,8$ mm · Innenloch- $\varnothing 20,25$ mm · passend für Spindel M 20		-	046190	75,45
V4598-12	Lagerscheibe $\varnothing 65,8 - 66,8$ mm · Innenloch- $\varnothing 20,25$ mm · passend für Spindel M 20		-	046206	75,45
V4598-13	Lagerscheibe $\varnothing 68,8 - 70,8$ mm · Innenloch- $\varnothing 20,25$ mm · passend für Spindel M 20		-	046213	79,65
V4598-14	Lagerscheibe $\varnothing 72,5 - 74,5$ mm · Innenloch- $\varnothing 20,25$ mm · passend für Spindel M 20		-	046220	79,65
V4598-15	Lagerscheibe $\varnothing 76,5 - 78,5$ mm · Innenloch- $\varnothing 20,25$ mm · passend für Spindel M 20		-	046237	79,65
V4598-16	Lagerscheibe $\varnothing 80,8 - 82,8$ mm · Innenloch- $\varnothing 20,25$ mm · passend für Spindel M 20		-	046244	83,60
V3060	Gegenhalter		-	030601	108,50
V4614	Nabenscheibe · konisch · $\varnothing 33,8$ mm · für V4598		-	046145	23,35
V4598-2	Nabenscheibe · konisch · $\varnothing 38,8$ mm · für V4598		-	046152	27,30
V4598-3	Nabenscheibe · konisch · $\varnothing 43,8$ mm · für V4598 · V4599		-	046169	32,35
V4598-4	Nabenscheibe · konisch · $\varnothing 59,8$ mm · für V4598		-	046176	42,25



**720,50 €**  
zzgl. MwSt.

**V2845**, EAN 4047728**028455**

## Lager- und Nabenschale

- Für Radlager und Nabe an z.B.:
  - FORD: C-Max
  - MAZDA: 3
  - Volvo: S40 · V50
  - ŠKODA: Octavia 1996 → 2004
  - VW: Golf 4 · Bora · Beetle
  - AUDI: A3 · S3 · TT 1999 → 2006
  - SEAT: León 1 · Toledo 2
- Sowie bestimmte Modelle von CITROËN · PEUGEOT · RENAULT und VAG mit geteilter Radlager/Nabe
- (Hinweis: Normaler Pressbügel passt hier nicht)
- Verwendung zusammen mit V4629



VIGOR No.	Bezeichnung	Ausführung	— L — mm	EAN 4047728+	€
V3040	Druckrohr · groß		120	030403	192,50
V3039	Druckscheibe · groß		-	030397	118,-

**209,50 €**  
zzgl. MwSt.

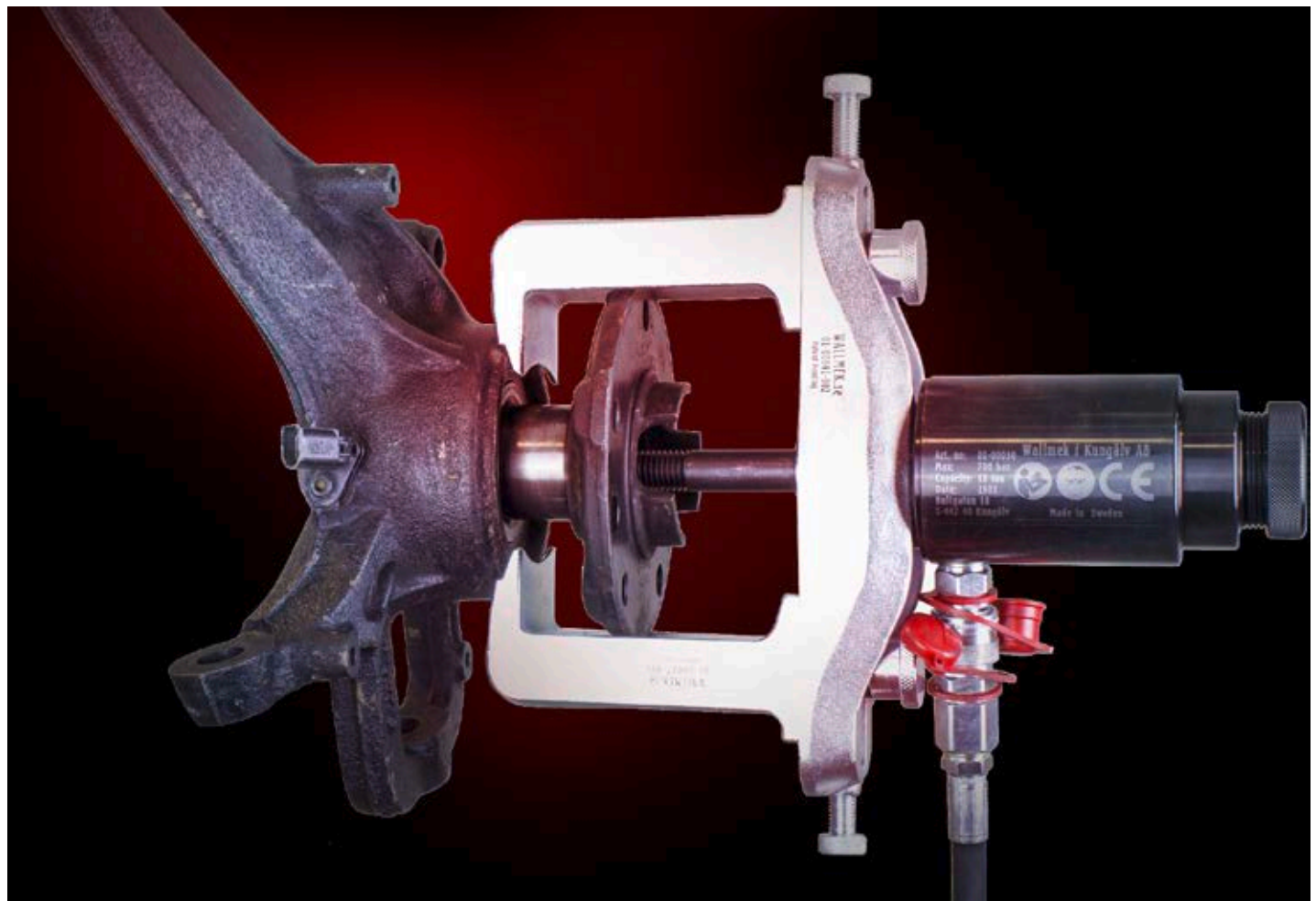

## V4599, EAN 4047728045995

### Radlager Satz AUDI Q7 · VW Touareg · PORSCHE Cayenne

- Radlagerwechsel an der Vorderachse
- Bei AUDI Q7 · VW Touareg · PORSCHE Cayenne
- Auswechseln des Radlagers an der Hinterachse bei AUDI Q7
- Form der Werkzeuge gewährleistet keine Beschädigung des ABS-Gebers
- Ergänzung Demontage Radnabe: V4629
- Ergänzung Demontage Radlager: V2860
- Begrenzung des Zeitaufwands auf circa 30 Minuten
- Radlagerwechsel direkt am Fahrzeug ohne zeitaufwendigen Ausbau

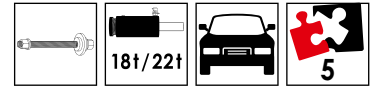

VIGOR No.	Bezeichnung	Ausführung	mm	EAN 4047728+	€
V3071	Lagerscheibe Ø 95 mm · Innenloch-Ø 20,25 mm · passend · für Spindel M 20		-	030717	102,50
V4598-30	Druckrohr Länge 78 mm für V4598 · V4599		78	046282	67,45
V3070	Lagerscheibe Ø 92 mm		-	030700	97,05
V4598-12	Lagerscheibe Ø 65,8 – 66,8 mm · Innenloch-Ø 20,25 mm · passend für Spindel M 20		-	046206	75,45
V4598-3	Nabenscheibe · konisch · Ø 43,8 mm · für V4598 · V4599		-	046169	32,35

**348,50 €**  
zzgl. MwSt.

## V4594, EAN 4047728045940

### Radlager-Fixierung · verstellbar

- Radlager, die nach innen ausgebaut werden
- Platte ermöglicht optimale Einstellung auf schiefer / ungleichmäßiger Oberfläche der Innenseite, so dass eine ebene Pressfläche entsteht
- Einsatz mit Hydraulikzylinder, mechanischer Spindel oder Werkstattpresse
- Verwendung zusammen mit V4629
- Demontage des Radlagers mit V4598
- An z.B.
  - CITROËN: Berlingo (Bj. 1996 →), Jumpy (Bj. 1995 →)
  - RENAULT: Clio (Bj. 1991 → 2012)
  - FIAT: Scudo (Bj. 1995 →)
  - PEUGEOT: Partner (Bj. 1996 →), Expert (Bj. 1995 →)
  - KIA: Rio (2001 → 2005), Ceéd (2006 → 2012)
  - HYUNDAI: i30 (Bj. 2007 →)



**Universal Fixierung für alle Lager, die nach hinten ausgedrückt werden**

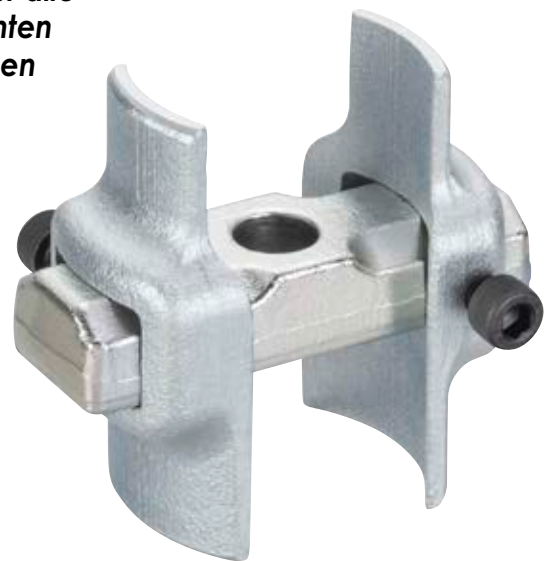

VIGOR No.	Bezeichnung	Ausführung	EAN 4047728+	€
V4594-1	Druckfuß Satz für V4594		045957	303,-*
V3060	Gegenhalter		030601	108,50

**354,- €**  
zzgl. MwSt.

\* Preis pro Satz



**V2860**, EAN 4047728028608

## Kompakt-Radlager Demontage Satz · universal

- Demontage Kompakt-Radlager mit oder ohne Sicherungsring
- Für z.B.:
  - VW: Polo · Lupo · Touareg · Fox · T5 vorne und hinten · Crafter
  - AUDI: A2
  - SEAT: Ibiza · Córdoba
  - ŠKODA: Fabia · Rapid · Roomster
  - FORD: Focus · C-Max · Mondeo · S-Max · Kuga
  - LANDROVER: Freelander 2
  - MAZDA: 3 · 5 · 6 · CX-7
  - MERCEDES-BENZ: Sprinter · Vito · Viano
  - MITSUBISHI: Colt
  - SMART: Forfour
  - Volvo: V50 · S40 · V70 · S80 · XC60
- Demontage der Radnabe an Pkw
- Ermöglicht den Einsatz mit mechanischer Spindel



*Verstellbarkeit gewährleistet Einsatz aller zur Zeit auf dem Markt erhältlichen sowie zukünftiger Kompakt-Radlager Typen*

VIGOR No.	Bezeichnung	Ausführung	EAN 4047728+	€
V3873	Fixierschraube · M 14		038737	83,75*
V3874	Schraube · M 12		038744	26,30*
V3871	Traverse für diverse Druckfüsse		038713	268,50
V3755	Druckfuß Satz (Demontage) für Kompakt-Radlager		037556	390,50**

\* Preis pro Stück \*\* Preis pro Satz

**579,- €**  
zzgl. MwSt.

**V7050**, EAN 4047728070508

## Demontagewerkzeug für geschraubte 4-Loch Naben / Radlager mit unebenem Bremsschutzblech

- Flexibel einstellbar, besonders für Modelle mit schwer zugänglichem Bremsschutzblech
- Demontage direkt am Fahrzeug
- Aufgrund von Korrosions-Einwirkungen sitzen diese Radlagerarten sehr fest und sind schwierig zu demontieren. Die Verwendung des Werkzeugs vermeidet Beschädigung der Achsschenkelteile oder des Bremsschutzblechs
- Für z.B.: SUBARU Forester · XV · Outback  
TOYOTA Aygo 2006 → 2019 · Avensis  
CITROËN C1  
PEUGEOT 107 · 108  
OPEL Vectra · Zafira  
CHRYSLER Voyager  
HYUNDAI I10  
SUBARU diverse Modelle



**378,50 €**  
zzgl. MwSt.

**V2864**, EAN 4047728028646

## Demontagescheibe · konisch · universal

- Konische Scheibe zur Demontage von Kompakt-Radlagern



Innendurchmesser 20,25 mm  
passend für M 20 Spindel

*Passend für alle Größen*

**50,65 €**  
zzgl. MwSt.



## V3731, EAN 4047728037310

### Demontage Satz, universal, für geschraubte Radlagereinheit

- Demontage geschraubte Radlagereinheiten (4 Bolzen) an Vorder- und Hinterachse
- Beidseitige Verwendung der Druckfüße gewährleistet einfache und schnelle Justierung am Achsschenkel
- Maximale Belastbarkeit: 22 Tonnen
- Verstellbarkeit gewährleistet Einsatz aller zur Zeit auf dem Markt erhältlichen geschraubten Radlagereinheiten mit 4 Bolzen
- Direkt am Fahrzeug einsetzbar
- Für: VAG · FORD · MAZDA · TOYOTA · MITSUBISHI · AUDI A4 · A6 · VW Passat · ŠKODA Octavia · SEAT Exeo etc.



VIGOR No.	Bezeichnung	Ausführung	EAN 4047728+	€
V3873	Fixierschraube · M 14		038737	83,75*
V3874	Schraube · M 12		038744	26,30*
V3871	Traverse für diverse Druckfüße		038713	268,50
V3758	Druckfuß Satz (Demontage) für geschraubte Radlagereinheiten		037587	392,50**

\* Preis pro Stück \*\* Preis pro Satz

Universell einstellbar  
für geschraubte  
Radlagereinheiten  
mit 4 Bolzen

**582,50 €**  
zzgl. MwSt.

## V3732, EAN 4047728037327

### Demontage Satz, universal, für geschraubte Radlagereinheit

- Demontage geschraubte Radlagereinheiten (3 Bolzen) an Vorder- und Hinterachse
- Beidseitige Verwendung der Druckfüße gewährleistet einfache und schnelle Justierung am Achsschenkel
- Maximale Belastbarkeit: 22 Tonnen
- Verstellbarkeit gewährleistet Einsatz aller zur Zeit auf dem Markt erhältlichen geschraubten Radlagereinheiten mit 3 Bolzen
- Direkt am Fahrzeug einsetzbar
- Für z.B.:
  - VW Golf 6 Cabrio Bj. 2013 → · Golf Bj. → 2012 · Touran Bj. 2015 → · Tiguan Bj. 2016 → · Passat Bj. 2014 →
  - AUDI A3 Bj. 2012 → · TT Bj. 2014 → · Q2 Bj. 2016 →
  - ŠKODA Octavia Bj. 2012 → · Superb Bj. 2015 →
  - SEAT León Bj. 2012 →
  - OPEL Insignia · Astra Bj. 2004 → · Corsa D → 2014
  - CHEVROLET/GMC Malibu
  - SAAB 95 Bj. 2010 →



VIGOR No.	Bezeichnung	Ausführung	EAN 4047728+	€
V3873	Fixierschraube · M 14		038737	83,75*
V3874	Schraube · M 12		038744	26,30*
V3871	Traverse für diverse Druckfüße		038713	268,50
V3753	Druckfuß Satz (Demontage) für geschraubte Radlagereinheiten		037532	392,50**

\* Preis pro Stück \*\* Preis pro Satz

Universell einstellbar  
für geschraubte  
Radlagereinheiten  
mit 3 Bolzen

**582,50 €**  
zzgl. MwSt.

**V5420**, EAN 4047728075275

## Standard Radlager Demontage / Montage Satz ROVER

- Demontage / Montage von Radlagern und Radnaben an ROVER
- Speziell angepasste AusbaufüÙe für stabilen und beschädigungsfreien Halt am Achsschenkel
- Aussparungen an Gegenhalteplatte – ABS Sensoren bleiben unberührt und müssen nicht getauscht werden
- Mit Adapterplatte zum Lösen des Sicherungsringes
- Für z.B.: Land Rover Discovery Sport L494 2013 → 2019 · Defender L663 2020 → Discovery Sport L550 2019 → · Discovery 5 L462 2017 → Range Rover Sport L494 2013 → · Vogue L405 2012 → · Evoque L538 2011 → · Velar L560 2017 →



**1.144,- €** zzgl. MwSt.

**V5425**, EAN 4047728075596

## Standard Radlager Erweiterungssatz ROVER

- Demontage / Montage von Radlagern und Radnaben an ROVER
- Speziell angepasste AusbaufüÙe für stabilen und beschädigungsfreien Halt am Achsschenkel
- Aussparungen an Gegenhalteplatte – ABS Sensoren bleiben unberührt und müssen nicht getauscht werden
- Mit Adapterplatte zum Lösen des Sicherungsringes
- Für z.B.: Land Rover Discovery Sport L494 2013 → 2019 · Defender L663 2020 → · Discovery Sport L550 2019 → · Discovery 5 L462 2017 → Range Rover Sport L494 2013 → · Vogue L405 2012 → · Evoque L538 2011 → · Velar L560 2017 →
- Für Vorder- und Hinterachse
- Hinweis: Zur vollständigen Bearbeitung wird Traverse V3871 inklusive Verschraubungen benötigt



**686,- €** zzgl. MwSt.

**V5421**, EAN 4047728075282

## Erweiterungssatz

- Demontage / Montage von Radlagern und Radnaben an ROVER
- Speziell angepasste AusbaufüÙe für stabilen und beschädigungsfreien Halt am Achsschenkel
- Aussparungen an Gegenhalteplatte – ABS Sensoren bleiben unberührt und müssen nicht getauscht werden
- Mit Adapterplatte zum Lösen des Sicherungsringes
- Für z.B.: Land Rover Discovery Sport L494 2013 → 2019 · Defender L663 2020 → · Discovery Sport L550 2019 → · Discovery 5 L462 2017 → Range Rover Sport L494 2013 → · Vogue L405 2012 → · Evoque L538 2011 → · Velar L560 2017 →
- Druckfuß Paar



**400,- €** zzgl. MwSt.

**V5422**, EAN 4047728075466

## Lagerplatte

- Demontage / Montage von Radlagern und Radnaben an ROVER
- Speziell angepasste AusbaufüÙe für stabilen und beschädigungsfreien Halt am Achsschenkel
- Aussparungen an Gegenhalteplatte – ABS Sensoren bleiben unberührt und müssen nicht getauscht werden
- Mit Adapterplatte zum Lösen des Sicherungsringes
- Für z.B.: Land Rover Discovery Sport L494 2013 → 2019 · Defender L663 2020 → · Discovery Sport L550 2019 → · Discovery 5 L462 2017 → Range Rover Sport L494 2013 → · Vogue L405 2012 → · Evoque L538 2011 → · Velar L560 2017 →
- Lagerplatte · Ø 85-95 mm

Ø 85 – 95 mm



**113,50 €** zzgl. MwSt.

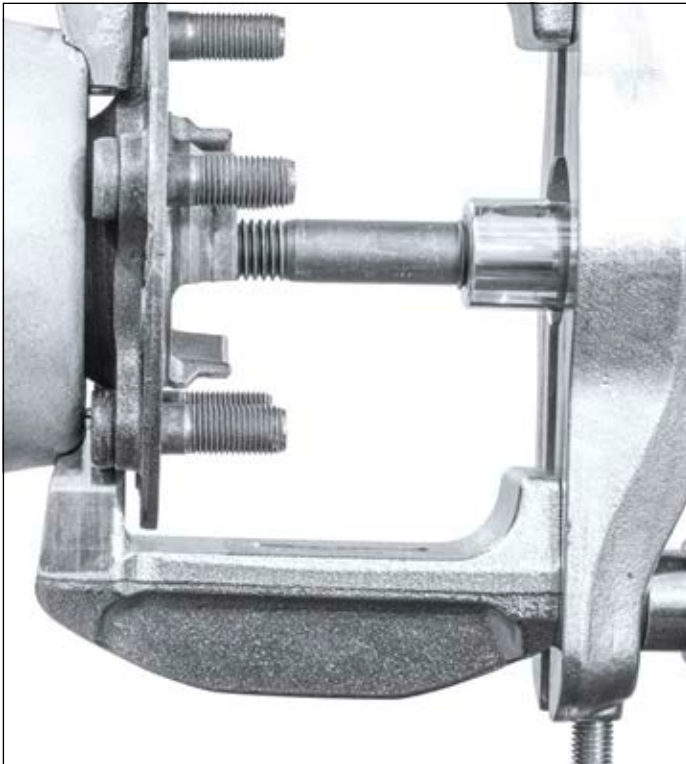

**V5423**, EAN 4047728075312

## Halteplatte

- Demontage / Montage von Radlagern und Radnaben an ROVER
- Speziell angepasste AusbaufüÙe für stabilen und beschädigungsfreien Halt am Achsschenkel
- Aussparungen an Gegenhalteplatte – ABS Sensoren bleiben unberührt und müssen nicht getauscht werden
- Mit Adapterplatte zum Lösen des Sicherungsring
- Für z.B.: Land Rover Discovery Sport L494 2013 → 2019 · Defender L663 2020 → · Discovery Sport L550 2019 → · Discovery 5 L462 2017 → · Range Rover Sport L494 2013 → · Vogue L405 2012 → · Evoque L538 2011 → · Velar L560 2017 →
- Halteplatte · Ø 89-105 mm

Ø 86 – 105 mm



**113,50 €**  
zzgl. MwSt.

**V5424**, EAN 4047728075329

## Lagerplatte

- Demontage / Montage von Radlagern und Radnaben an ROVER
- Speziell angepasste AusbaufüÙe für stabilen und beschädigungsfreien Halt am Achsschenkel
- Aussparungen an Gegenhalteplatte – ABS Sensoren bleiben unberührt und müssen nicht getauscht werden
- Mit Adapterplatte zum Lösen des Sicherungsring
- Für z.B.: Land Rover Discovery Sport L494 2013 → 2019 · Defender L663 2020 → · Discovery Sport L550 2019 → · Discovery 5 L462 2017 → · Range Rover Sport L494 2013 → · Vogue L405 2012 → · Evoque L538 2011 → · Velar L560 2017 →
- Lagerplatte · Ø 95 mm

Ø 95 mm



**90,50 €**  
zzgl. MwSt.

**V2859**, EAN 4047728028592

## Gegenhalteplatte (Montage)

FORD · MAZDA · Volvo

- Für z.B.:
  - FORD: Mondeo, Focus, C-Max, S-Max, Kuga
  - MAZDA: 3 bis 6 · 5 · CX7
  - Volvo: V70 Bj. 2007 →, S40 · V50 Bj. 2004 →
  - LANDROVER: Freelander 2-14



Innendurchmesser 20,25 mm  
für M 20 Spindel geeignet

**70,05 €**  
zzgl. MwSt.

**V8180**, EAN 4047728081979

## Gegenhalteplatte Montage VAG

- Platte zum Abstützen beim Einbau von Kompaktradlagern
- Innendurchmesser: 20,5 mm
- Für z.B.:
  - VW: Polo 2018 → · T-Cross 2018 → · Taigo 2020 →
  - AUDI: A1 2018 →
  - SEAT: Ibiza 2018 →
  - ŠKODA: Scala 2019 → · Kamiq 2019 → · Fabia 2021 →
  - Mitsubishi: Colt 2004 → 2013
  - Smart: Forfour 2004 → 2006



**NEU**

**105,- €**  
zzgl. MwSt.

**V2861**, EAN 4047728028615

## Gegenhalteplatte (Montage) VW · AUDI · SEAT · ŠKODA

- Für z.B.:
  - VW: Polo, Lupo, Fox
  - AUDI: A2
  - SEAT: Ibiza, Córdoba
  - ŠKODA: Fabia
  - SMART: Forfour
  - MITSUBISHI: Colt



**77,30 €**  
zzgl. MwSt.

**V2862**, EAN 4047728028622

## Gegenhalteplatte (Montage) VW

- Für z.B.:
  - VW: T5 vorne und hinten, Touareg
  - MERCEDES-BENZ: Vito und Viano Hinterachse



Innendurchmesser 20,25 mm  
für M 20 Spindel geeignet

**105,50 €**  
zzgl. MwSt.

**V2863**, EAN 4047728028639

## Montagering FORD · MAZDA · Volvo

- Tieferes Einpressen des Kompakt-Radlagers in das Radlagergehäuse
- Für z.B.:
  - FORD: Mondeo · S-Max
  - MAZDA: 6
  - Volvo: V70 Bj. 2007 → · S80 · V60 · XC60 · XC70



**77,30 €**  
zzgl. MwSt.

**V6824**, EAN 4047728068246

## Halbschalen Satz für die Montage von 92 mm Kompakt-Radlager

- Radlagerwechsel direkt am Fahrzeug, ohne Demontage des Achsschenkels
- Fachmännische Montage mit Hilfe eines speziellen Adapterrings vermeidet innere Schäden am Kompakt-Radlager durch unsachgemäße Montage und Druck auf Radnaben
- Demontage des Radlagers auch in Verbindung mit dem Werkzeugen V2860 · V2864 · V5027
- Montage mit Werkzeugen V4491 · V2862
- Zusätzlich werden hydraulische oder manuelle Antriebswerkzeuge benötigt
- Für u.a.:
  - PEUGEOT Expert · Traveller Bj. 2016 →
  - CITROËN Spacetourer Bj. 2016 →
  - TOYOTA Proace · Proace Verso Bj. 2016 →



**126,- €**  
zzgl. MwSt.



## V5903N, EAN 4047728075237

### Radlager-Abzieher

- Demontage geschraubter Radlagereinheiten (mit 3 oder 4 Bolzen) an Vorder- und Hinterachse bei demontierter Radnabe
- Nur in Verbindung mit V3731 und V3732
- Direkt am Fahrzeug einsetzbar
- Maximale Belastbarkeit: 18 Tonnen
- Für z.B. AUDI A4 Bj. 2007 → 2016 · A5 Bj. 2007 → 2017 · A6 Bj. 2011 → · A7 Bj. 2010 → · A8 Bj. 2010 → · Q5 Bj. 2008 →



VIGOR No.	Bezeichnung	Ausführung	EAN 4047728+	€
V5903-3	Zugstange · M 22 · 121 mm	—	059077	35,10

**320,- €**  
zzgl. MwSt.

## V7061, EAN 4047728070614

### Schrauben Satz · SUBARU · Hinterradlager

- Demontage des hinteren Radlagers am SUBARU mit Werkzeug V5903N erfordert längere Lagerbolzen
- Satz bestehend aus 4 Sechskant-Schrauben M 12x1,25x100 mm für das Gewinde des Lagers
- Unterlegscheiben mit flacher Seite zum Schraubenkopf verwenden
- Für z.B. SUBARU Legacy · Impreza · Forester · Outback · XV



Radlager-Abzieher V5903N optional erhältlich



**39,- €**  
zzgl. MwSt.

## V7071, EAN 4047728078610

### Schrauben Satz · VAG

- Demontage von Radlagern der Generation 3 (geschraubt und geteilt) bei diversen VAG Achsschenkeln z.B.: AUDI: A6 · A7
- Originale Verschraubungen der Radlager können nicht für die Demontage verwendet werden
- Schrauben Satz nur in Kombination mit dem Radlager-Abzieher V5903N verwendbar
- Inhalt: 4x Sechskant-Schraube M12x1,5x60 mm



**41,35 €**  
zzgl. MwSt.

**V4491**, EAN 4047728**044912**

## Kompakt-Radlager Montage Satz · universal

- Montage Kompakt-Radlager mit oder ohne Sicherungsring
- Maximale Belastbarkeit: 22 Tonnen
- An z.B.:
  - VW: Polo · Lupo · Touareg · Fox · T5 vorne und hinten · Crafter
  - AUDI: A2
  - SEAT: Ibiza · Córdoba
  - ŠKODA: Fabia · Rapid · Roomster
  - FORD: Focus · C-Max · Mondeo · S-Max · Kuga
  - LANDROVER: Freelander 2
  - MAZDA: 3 · 5 · 6 · CX-7
  - MERCEDES-BENZ: Sprinter · Vito · Viano
  - MITSUBISHI: Colt
  - SMART: Forfour
  - Volvo: V50 · S40 · V70 · S80 · XC60
- Einsatz mit Hydraulikzylinder, mechanischer Spindel oder Werkstattpresse



Verstellbarkeit  
gewährleistet Einsatz an  
allen zur Zeit auf dem  
Markt erhältlichen sowie  
an zukünftigen Kompakt-  
Radlager Typen

VIGOR No.	Bezeichnung	Ausführung	EAN 4047728+	€
V3873	Fixierschraube · M 14		038737	83,75
V3874	Schraube · M 12		038744	26,30
V3871	Traverse für diverse Druckfüsse		038713	268,50
V4493	Druckfuß (Paar) für Kompakt-Radlager-Montagewerkzeug Satz · universal		044936	406,-

**653,50 €**  
zzgl. MwSt.

\* Preis pro Stück \*\* Preis pro Satz

**V4491-A**, EAN 4047728**081764**

## Zentrierhilfe Kompaktradlager

- Geführter und kipffreier Einbau von Kompaktradlagern
- In Abhängigkeit des Radlagerherstellers, kann es zu Problemen beim Einbau kommen. Durch die Verwendung der Zentrierhilfe, können ebenfalls nicht angefasste Radlager problemlos montiert werden.
- In Verbindung mit Kompakt-Radlager Montage Satz · universal V4491
- Innenzentrierung für die Durchmesser der Kompaktradlager:
  - 26,4 mm = 78 mm
  - 27,2 mm = 92 mm
  - 27,4 mm = 72 – 78 mm
  - 29,5 mm = 82 mm
  - 29,6 mm = 85 mm

**NEU**



**370,- €**  
zzgl. MwSt.

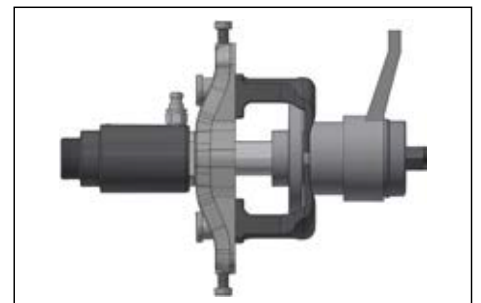
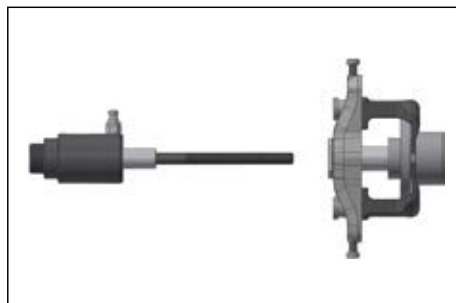
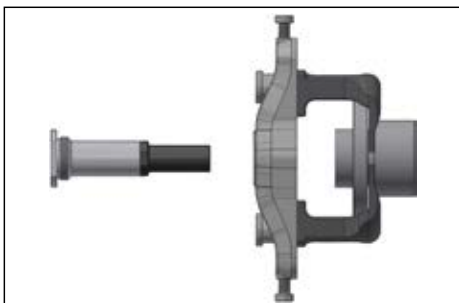

**V7027**, EAN 4047728075244

## Radnaben- / Lagerabzieher

- Demontage geschraubter Radlager mit geschlossener Nabe an Pick-Ups und Transportern
- Nur in Verbindung mit V3731 · V3732 · V2860 und Hydraulikzylinder 16 t bis 22 t
- Lochkreis 4- und 5-Loch: 120 – 170 mm
- Für Modelle mit geschlossener Nabe: DODGE Ram 1500 · FORD Transit



**342,50 €**  
zzgl. MwSt.

**V5027**, EAN 4047728050272

## Radnaben-Abzieher

- Demontage geschraubte Radlagereinheiten mit geschlossener Nabe
- Antriebswelle muss nicht mehr vorher entfernt werden
- Verwendung in Verbindung mit Radlager- / Nabenwerkzeug V3731 · V3732 · V2860 sowie Hydraulikzylinder 16 – 22 Tonnen
- Lochkreis 4- und 5-Loch: 92 – 131 mm
- Hinweis: Werkzeug nicht mit mehr als 18 Tonnen belasten
- Für Modelle mit geschlossener Nabe, u.a.:
  - OPEL Insignia Bj. 2010 →
  - SAAB 9-5 Bj. 2010 →
  - CITROËN C1 Bj. 2006 → Jumpy Bj. 2016 → SpaceTourer Bj. 2016 →
  - PEUGEOT 108 Bj. 2015 → Expert Bj. 2016 → Traveller
  - TOYOTA Aygo Bj. 2006 → ProAce (Verso)



**Radnaben-Demontage  
ohne vorheriges Ausbauen  
der Antriebswelle**



**260,- €**  
zzgl. MwSt.





**V5905**, EAN 4047728059152

## Radnaben- / Radlager- Abzieher · für 6 und 8 Bolzen

- Demontage verschraubte Radlager und Nabeneinheiten direkt am Fahrzeug
- Nur in Verbindung mit V5906 und V2860
- Demontage einer geschlossenen Nabe
- Demontieren der Antriebswelle nicht notwendig
- Die mitgelieferten M 22-Gewindestangen verbinden das Werkzeug mit einem unserer Hydraulikzylinder
- Für Lochkreis (6 Loch) 111,5 – 142,5 mm, (8 Loch) 162,5 – 182,5 mm



**456,- €**  
zzgl. MwSt.

**V5906**, EAN 4047728059183

## Radlagereinheit · geschraubt · Demontage Satz · universal

- Demontage geschraubte Radlager mit 3 / 4 Bolzen
- Speziell konstruierte Pressfüße erlauben Demontage der Radlager bei SUV und US Pickups
- Radnaben von Größen bis 180 mm sind durch die verstellbare Traverse demontierbar
- Erhitzen der Bauteile und die dadurch verbundene Beschädigung wird ausgeschlossen
- Durch die zusätzliche Verwendung von V5905 ist die Demontage der Antriebswelle nicht notwendig
- Für: DODGE · CHEVROLET/GMC · FORD Ranger Bj. 2011 →



**SUV / VAN Radnaben mit  
6 und 8 Stehbolzen  
Universell einstellbar bis maximal  
180 mm im Durchmesser**

VIGOR No.	Bezeichnung	Ausführung	EAN 4047728+	€
V3873	Fixierschraube · M 14		038737	83,75
V3874	Schraube · M 12		038744	26,30
V3871	Traverse für diverse Druckfüße		038713	268,50
V5906-1	Druckfuß Satz		059190	589,-

**911,50 €**  
zzgl. MwSt.

# Werkzeugsätze geschraubte Kompakt-Radlager Werkzeugsätze Antriebswellen



**V7859**, EAN 4047728078597

## Radlager Demontage Satz · Steckachsen

- Effizientes und sicheres Trennen des Radlagers von der Halbachse direkt am Fahrzeug
- Die Nabenachse wird mithilfe des Radnaben-Abziehers aus dem Radlager nach vorne demontiert
- Durch spezielle Auflage-Elemente wird eine Beschädigung des Bremshitzschildes vermieden
- Für z.B.:  
VW Amarok Bj. 2010 →  
MITSUBISHI L200 Bj. 2006 →  
TOYOTA Hilux Bj. 2005 →



VIGOR No.	Bezeichnung	Ausführung	EAN 4047728+	€
V7860	Abstützbacke		078603	41,35
V5905	Radnaben- / Radlager-Abzieher · für 6 und 8 Bolzen		059152	456,-
V5027	Radnaben-Abzieher		050272	260,-
V5906	Radlagereinheit · geschraubt · Demontage Satz · universal		059183	911,50

**1.325,- €** zzgl. MwSt.

**V5904**, EAN 4047728059084

## Antriebswellen-Auspressvorrichtung · 6- und 8-Loch

- Auspressen von verrosteten oder geklebten Antriebswellen direkt am Fahrzeug
- Für Lochkreis (6 Loch) 114 – 140 mm, (8 Loch) 165 bis 180 mm
- Antriebswelle mit 22 Tonnen Hydraulikzylinder auspressen (Montage des Schlagkörpers ermöglicht zusätzliche Kraftaufbringung über Einsatz eines Hammers)
- Befestigung mit den am Fahrzeug vorhandenen Radmuffern oder Radschrauben

*Einstellbar, passend für Lochkreis  
(6-Loch) von 114 bis 140 mm und  
(8-Loch) von 165 bis 180 mm*

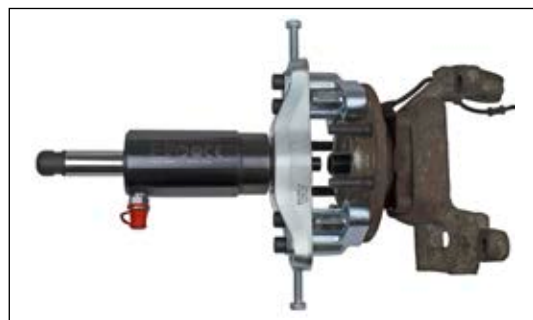

VIGOR No.	Bezeichnung	Ausführung	EAN 4047728+	€
V5904-1	Druckfuß Satz		059114	456,-**
V3871	Traverse für diverse Druckfüsse		038713	268,50
V5904-3	Gleitteller		059138	14,35*
V5904-4	Schraube · M 14 × 2 – 45 · Innensechskant		059145	13,-*

**720,50 €** zzgl. MwSt.

\* Preis pro Stück \*\* Preis pro Satz



## V4700-L

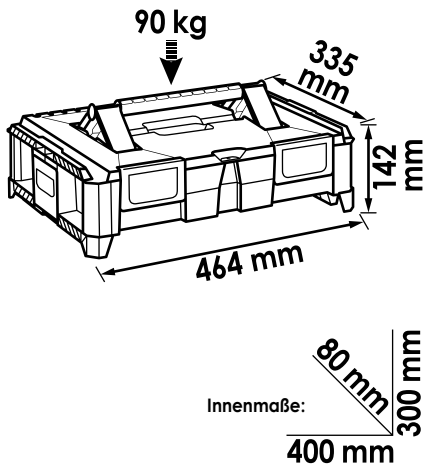

## V4700-XL

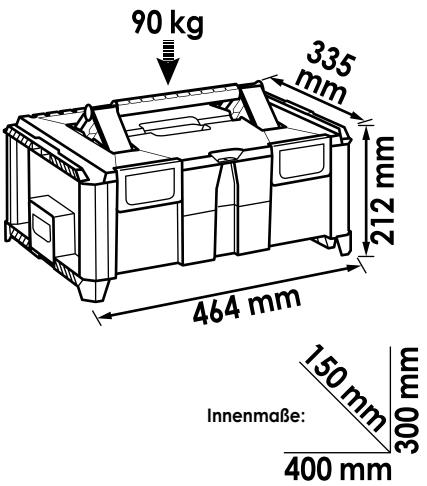

## V4700-XXL

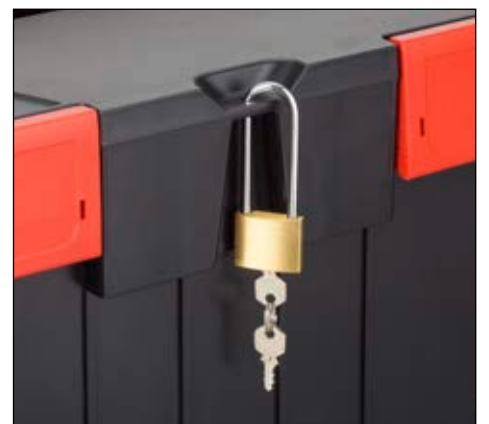
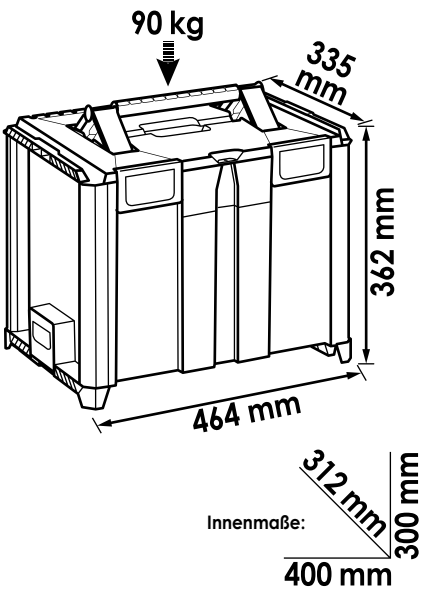

**V5128**, EAN 4047728051286

## Standard Radlager / Radnaben Demontage / Montage Satz

- Inklusive Multibox
- Effektive Methode zur Demontage von Radnaben. Empfehlung: Verwendung Radlager Satz V4598. Satz funktioniert auch bei Achsschenkeln mit unebenen und begrenzten Flächen
- Deutliche Zeitersparnis zu bisherigen Systemen
- In Verbindung mit Hydraulikzylinder oder manueller Spindel
- Wechseln des Radlagers direkt am Fahrzeug bei minimalem Zeitaufwand
- Kein Ausbau von ABS-Geber, Achsschenkel, Federbein oder Spurstangengelenk
- Radeinstellung oder Bremsanlagen-Entlüftung nicht erforderlich
- Alle Teile sind für die heute auf dem Markt befindlichen Radlagergrößen angepasst
- Montagescheiben haben eine Führung und sind zweiseitig verwendbar
- Montagescheiben mit  $\varnothing 62 - 83$  mm und Nabenscheiben  $34 - 60$  mm sind enthalten, die Lagerschale ist für Radlager bis  $92$  mm  $\varnothing$  geeignet

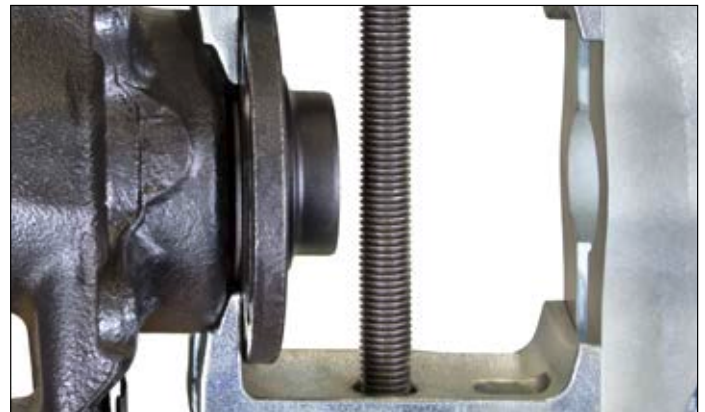
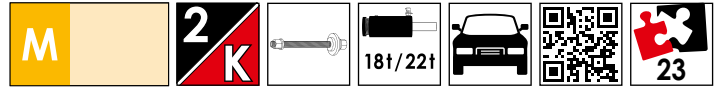

VIGOR No.	Bezeichnung	Ausführung	EAN 4047728+	€
V4598	Radlager-, Antriebsachsen und Radnaben Satz · universal		045988	720,50
V4629	Radnaben Demontage-Werkzeug · universal		046299	594,-

**1.302,- €** zzgl. MwSt.



**V5549**, EAN 4047728**055499**

## Multibox V4700-L · Kompakt- Radlager / -Nabe Erweiterungssatz

- In Verbindung mit dem Satz V4680, können alle derzeit bekannten Radlager montiert und demontiert werden
- Erweiterungs Satz aufbauend für z.B. V4680
- Beinhaltet Druckfüße zum Demontieren aller bekannten Radnaben
- Zusätzliche Demontage-Druckfüße für geschraubte Radlagereinheiten (3 und 4 Bolzen) an Vorder- und Hinterachse VAG · OPEL uvm.
- Verstellbarkeit gewährleistet Einsatz aller zur Zeit auf dem Markt erhältlichen geschraubten Radlagereinheiten mit 3 und 4 Bolzen
- z.B. für 4 Bolzen:
  - AUDI A4 · A6
  - VW Passat
  - ŠKODA Octavia
  - SEAT Exeo
- z.B. für 3 Bolzen:
  - VW Golf 6 Cabrio Bj. 2013 → · Golf Bj. → 2012 · Touran Bj. 2015 → · Tiguan Bj. 2016 → · Passat Bj. 2014 →
  - AUDI A3 Bj. 2012 → · TT Bj. 2014 → · Q2 Bj. 2016 →
  - ŠKODA Octavia Bj. 2012 → · Superb Bj. 2015 →
  - SEAT León Bj. 2012 →
  - OPEL Insignia, Astra Bj. 2004 →
  - CHEVROLET/GMC Malibu
  - SAAB 95 Bj. 2010 →
- Verwendung mit Traverse V3871

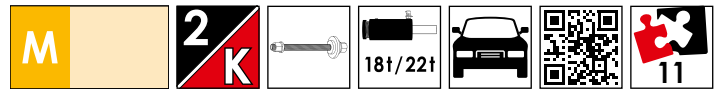

Zweitelliges Standard-Radlager



3 Bolzen geschraubte Radlagereinheiten



4 Bolzen geschraubte Radlagereinheiten



VIGOR No.	Bezeichnung	Ausführung	l mm	EAN 4047728+	€
V3753	Druckfuß Satz (Demontage) für geschraubte Radlagereinheiten		-	037532	392,50
V3758	Druckfuß Satz (Demontage) für geschraubte Radlagereinheiten		-	037587	392,50
V4629-1	Druckfuß Satz für V4629		-	046305	392,50
V4598-30	Druckrohr Länge 78 mm für V4598 · V4599		78	046282	67,45
V4614	Nabenscheibe · konisch · Ø 33,8 mm · für V4598		-	046145	23,35
V4598-2	Nabenscheibe · konisch · Ø 38,8 mm · für V4598		-	046152	27,30
V4598-3	Nabenscheibe · konisch · Ø 43,8 mm · für V4598 · V4599		-	046169	32,35
V4598-4	Nabenscheibe · konisch · Ø 59,8 mm · für V4598		-	046176	42,25

**1.302,- €** zzgl. MwSt.

**V5549-1N**, EAN 4047728075909

## Kompakt-Radlager und Radnabe Erweiterungssatz

- Demontage / Montage aller derzeit bekannten Radlager (in Verbindung mit Kompakt Radlager Demontage- und Montage Satz V4680)
- Zusätzliche Demontage-Druckfüße für geschraubte Radlagereinheiten (3 und 4 Bolzen) an Vorder- und Hinterachse VAG · OPEL uvm.
- Erweiterungssatz z.B. für V4680
- Verstellbarkeit gewährleistet Einsatz aller zur Zeit auf dem Markt erhältlichen geschraubten Radlagereinheiten mit 3 und 4 Bolzen
- z.B. für 4 Bolzen:
  - AUDI A4 · A6
  - VW Passat
  - ŠKODA Octavia
  - SEAT Exeo
- z.B. für 3 Bolzen:
  - VW Golf 6 Cabrio Bj. 2013 → · Golf Bj. → 2012 ·
  - Touran Bj. 2015 → · Tiguan Bj. 2016 → · Passat Bj. 2014 →
  - AUDI A3 Bj. 2012 → · TT Bj. 2014 → · Q2 Bj. 2016 →
  - ŠKODA Octavia Bj. 2012 → · Superb Bj. 2015 →
  - SEAT León Bj. 2012 →
  - OPEL Insignia · Astra Bj. 2004 →
  - CHEVROLET/GMC Malibu
  - SAAB 95 Bj. 2010 →
- Verwendung mit Traverse V3871



3 Bolzen geschraubte Radlagereinheiten



4 Bolzen geschraubte Radlagereinheiten



4 Bolzen geteilte und verschraubte Radlagereinheit



Geteilte verpresste Radnabe



VIGOR No.	Bezeichnung	Ausführung	EAN 4047728+	€
V5903N	Radlager-Abzieher für geschraubte Radlager		075237	320,-
V5027	Radnaben-Abzieher		050272	260,-
V3753	Druckfuß Satz (Demontage) für geschraubte Radlagereinheiten		037532	392,50
V3758	Druckfuß Satz (Demontage) für geschraubte Radlagereinheiten		037587	392,50



**1.302,- €** zzgl. MwSt.



**V5168**, EAN 4047728051682

## Antriebswellen-Auspressvorrichtung Satz

- Inklusive Multibox
- Auspressen von verrosteten und geklebten Antriebswellen direkt am Fahrzeug
- Arbeitsdauer nur circa 5 Minuten
- Für alle Pkw mit 4- und 5-Loch-Nabe durch ovale Löcher für Radschrauben
- Vermeidet Erwärmung, Beschädigung der Antriebswelle oder Schäden an anderen Teilen
- Anwendung: Nabe mit Radschrauben des Fahrzeugs verschrauben, Antriebswelle mit 18 Tonnen oder 22 Tonnen Hydraulikzylinder auspressen (Montage des Schlagkörpers ermöglicht zusätzliches Kraftaufbringen über Einsatz eines Hammers), Herausziehen der Radnabe mit Schlaghammer V2922 und Adapter V2872

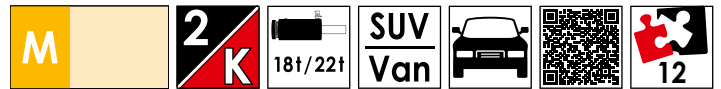

VIGOR No.	Bezeichnung	Ausführung	l mm	EAN 4047728+	€
V2849	Antriebswellen-Auspressvorrichtung · 4- und 5-Loch		-	028493	616,50
V2854	Druck- und Zug-Hydraulikzylinder 22 Tonnen		202	028547	1.011,50

**1.429,- €**  
zzgl. MwSt.



**V4680**, EAN 4047728**046800**

## Kompakt-Radlager Demontage / Montage Satz

- Inklusive Multibox
- Maximale Belastbarkeit: 22 Tonnen
- Einsatz mit Hydraulikzylinder z.B. V2854 in Kombination mit Hydraulikpumpe V2846 bzw. V2847
- Alternativer Einsatz mit mechanischer Spindel V2853
- An z.B.:
  - VW: Polo · Lupo · Touareg · Fox · T5 vorne und hinten · Crafter
  - AUDI: A2
  - SEAT: Ibiza, Córdoba
  - ŠKODA: Fabia, Rapid, Roomster
  - FORD: Focus, C-Max, Mondeo, S-Max, Kuga
  - LANDROVER: Freelander 2
  - MAZDA: 3 · 5 · 6 · CX-7
  - MERCEDES-BENZ: Sprinter, Vito, Viano
  - MITSUBISHI: Colt
  - SMART: Forfour
  - Volvo: V50 · S40 · V70 · S80 · XC60
  - Weitere Modelle
  - CITROËN: Jumpy (Dispatch), Space Tourer
  - PEUGEOT: Expert, Traveller
  - TOYOTA: ProAce (Verso)

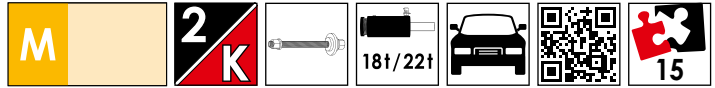

Verstellbarkeit gewährleistet Einsatz an allen zur Zeit auf dem Markt erhältlichen, sowie an zukünftigen Kompakt-Radlager Typen



Demontage



Montage



Ø 62 mm

Ø 66 mm

Ø 72 mm

Ø 75 mm

Ø 78 mm

Ø 82 mm

Ø 85 mm

Ø 92 mm



VIGOR No.	Bezeichnung	Ausführung	EAN 4047728+	€
V2860	Kompakt-Radlager Demontage Satz · universal		028608	579,-
V2864	Demontagescheibe · konisch · universal		028646	50,65
V3680	Kompakt-Radlager Montage Satz · universal		036801	948,-



**1.299,- €** zzgl. MwSt.



**V5554**, EAN 4047728055543

## Kompakt-Radlager Demontage / Montage Satz mit Hydraulik-Fußpumpe

- Inklusive Multibox
- V4680 Universal Werkzeug Satz zur Kompakt-Radlager Demontage und Montage
  - Einsatz an allen zur Zeit auf dem Markt erhältlichen Kompakt-Radlagern
  - Einfacher Verstell-Mechanismus ermöglicht Arbeiten mit Lagern der  $\varnothing 62 - 96$  mm
- V2854 Druck- und Zug-Hydraulikzylinder 22 Tonnen
  - Druckfunktion – Benutzung verstärkt kurzzeitig die Kraft bei Verwendung des Schlagkörpers. Anwendung, z.B. bei korrodierten Antriebswellen oder bei Arbeiten mit dem Pressstativ
  - Automatische Kolbenrücklauf-Funktion
- V2847 Hydraulische Fußpumpe
  - Für alle VIGOR Hydraulikzylinder
  - Antriebsdruck: 700 bar
  - Schlauchlänge: 2,2 m
  - Öl-Fassungsvermögen: 0,75 l
  - Pumpe beinhaltet eine CEJN Schnellkupplung
  - Satz in Weichschaum-Einlage, mit Multibox L

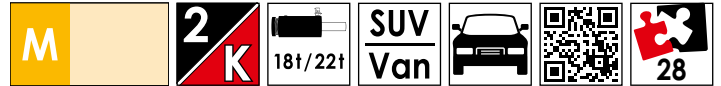

## Universal Satz zur Demontage und Montage aller Kompakt-Radlager



VIGOR No.	Bezeichnung	Ausführung	mm	XX	EAN 4047728+	€
V4680	Kompakt-Radlager Demontage / Montage Satz		-	15	046800	1.299,-
V2854	Druck- und Zug-Hydraulikzylinder 22 Tonnen		202	-	028547	1.011,50
V2847	Hydraulische Fußpumpe		-	-	028479	665,50

**2.591,50 €** zzgl. MwSt.

**V5554-2**, EAN 4047728069021

## Kompakt-Radlager Demontage / Montage Satz mit Pneumatik-Fußpumpe

- Inklusive Multibox
- V4680 Universal Werkzeug Satz zur Kompakt-Radlager Demontage und Montage
  - Einsatz an allen zur Zeit auf dem Markt erhältlichen Kompakt-Radlagern
  - Einfacher Verstell-Mechanismus ermöglicht Arbeiten mit Lagern der  $\varnothing 62 - 96$  mm
- V2854 Druck- und Zug-Hydraulikzylinder 22 t
  - Druckfunktion-Benutzung verstärkt die Kraft bei Verwendung des Schlagkörpers kurzzeitig um ein Vielfaches
  - Anwendung, z.B. bei korrodierten Antriebswellen oder bei Arbeiten mit dem Pressstativ
  - Automatische Kolbenrücklauf-Funktion
- V2846 Hydraulikpumpe, pneumatisch
  - Für alle Hydraulikzylinder
  - Ausführung inklusive Manometer



*Universal Satz zur Demontage und Montage aller Kompakt-Radlager*



VIGOR No.	Bezeichnung	Ausführung	L mm	XX	EAN 4047728+	€
V4680	Kompakt-Radlager Demontage / Montage Satz		-	15	046800	1.299,-
V2854	Druck- und Zug-Hydraulikzylinder 22 Tonnen		202	-	028547	1.011,50
V2846	Hydraulikpumpe · pneumatisch		-	-	028462	925,-



**2.837,50 €**  
zzgl. MwSt.



**V7857**, EAN 4047728078924

## Traggelenk-Hülsen

- Inklusive Multibox
- Umfangreiche Zusammenstellung für zahlreiche Gelenke der VAG · BMW und MERCEDES-BENZ Achsen
- Umfangreicher Satz von Traggelenk-Hülsen für die gängigsten Modelle
- Verwendung mit Press-Stativ V2885 und 14 t Druck-Hydraulikzylinder V2869
- Effektives und komfortables Arbeiten dank kompakter Bauform des Zylinders
- Vorteile des Kugelgelenk-Ausdrücker V5916-XL: 8,8 t Druckkraft
- Auspressen von Kugelgelenkzapfen und Stabilisatoren
- Auspressen von Lenk- und Bremshebeln bei Nkw und Bussen



# Multiboxen

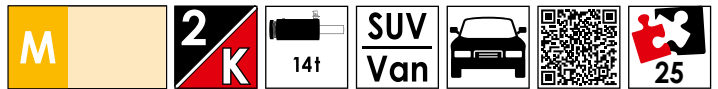

VIGOR No.	Bezeichnung	Ausführung	mm	EAN 4047728+	€
V5916-XL	Kugelgelenk-Ausdrücker · hydraulisch 8,8 Tonnen		-	066471	1.350,-
V3129	Druckstück · verstellbar M 24		132	031295	86,95
V2869	Druck-Hydraulikzylinder 14 Tonnen		138	028691	519,-
V2903	Druckstück für Traggelenk-Werkzeug		-	029032	101,50
V2897	Druckstück für Traggelenk-Werkzeug		-	028974	138,50
V2898	Druckstück für Traggelenk-Werkzeug NISSAN Interstar · OPEL Movano · RENAULT Master · HYUNDAI Trajet · Santa Fé		-	028981	126,-
V2899	Druckstück für Traggelenk-Werkzeug NISSAN Interstar · OPEL Movano · RENAULT Master		-	028998	117,-
V2895	Druckstück für Traggelenk-Werkzeug		-	028950	130,-
V2894	Druckstück Traggelenk-Werkzeug (Ausbau)		-	028943	174,-
V2893	Druckstück für Traggelenk-Werkzeug		-	028936	101,50
V2900	Druckstück für Traggelenk-Werkzeug VW LT35		-	029001	117,-
V2901	Druckstück für Traggelenk-Werkzeug		-	029018	94,95
V2885	Press-Stativ mit offener Platte mit Adapter um Platte zu schließen		-	028851	392,50
V4700-XXL	Multibox-XXL · leer		-	049276	85,95



**3.200,- €** zzgl. MwSt.

**V7857-L, EAN 4047728078573**  
Weichschaum-Einlage · leer



**89,10 €** zzgl. MwSt.



**V7133**, EAN 4047728071338

## Kompakt-Radlager Demontage / Montage Satz

- Inklusive Multibox
- Befähigung aller Kompakt-Radlager von Smart bis Sprinter
- Verwendete Montageeinheit V4491 gewährleistet fachmännische Montage des Kompakt-Radlagers der zweiten Generation
- Inhalt: Spezialeinheit zur Montage des geschlossenen Radlagers sowie Universal Satz für alle weiteren Kompakt-Radlager Durchmesser
- Kosten- und Zeitersparnis durch Entfallen des Verbauens eines neuen Achsschenkels, der anschließenden Achsvermessung sowie dem damit verbundenen Mehraufwand
- Inklusive zwei Multiboxen V4700-L

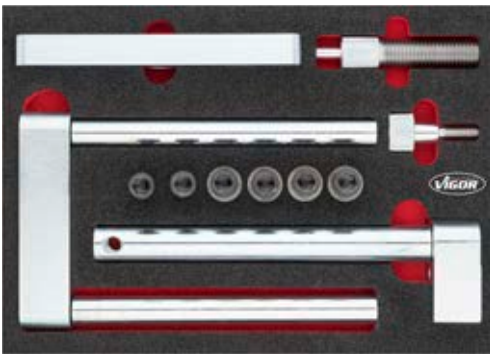
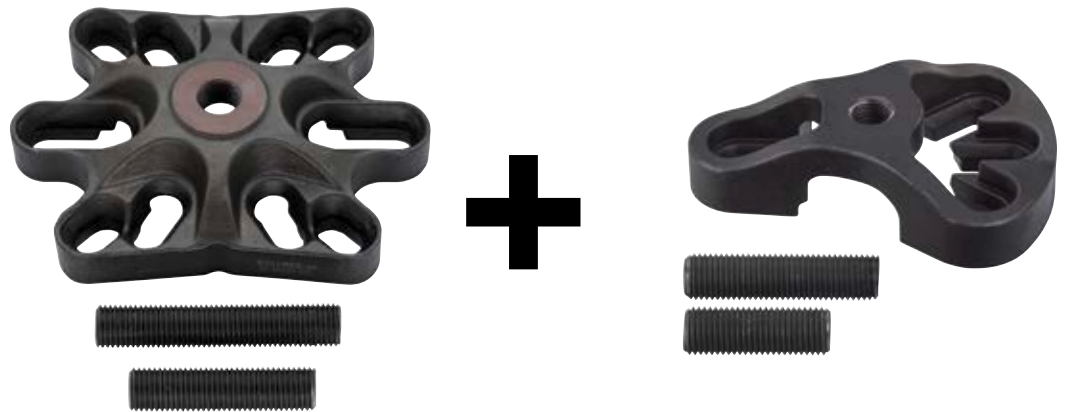

VIGOR No.	Bezeichnung	Ausführung		EAN 4047728+	€
V7133N	Kompakt-Radlager Montage-Erweiterungssatz		14	071703	1.138,50
V4680	Kompakt-Radlager Demontage / Montage Satz		15	046800	1.299,-
V5027	Radnaben-Abzieher		-	050272	260,-
V5905	Radnaben- / Radlager-Abzieher · für 6 und 8 Bolzen		-	059152	456,-



**2.529,50 €**  
zzgl. MwSt.

**V7133N**, EAN 4047728071703

## Kompakt-Radlager Montage- Erweiterungssatz

- Betätigung von Kompakt-Radlagern an Sprinter · Vito · Viano · Crafter
- Hinweis: Verwendung herkömmlicher Werkzeug Sätze ist nicht möglich, da geschlossenes Radlager verbaut ist. Antrieb mit Spindelsystem ist nicht durchführbar
- Spezieller Satz zur Montage des an der Radnabe geschlossenen Radlagers u.a. für folgende Fahrzeuge:
  - MERCEDES-BENZ V-Klasse Bj. 2014 → · Viano Bj. 2003 → · Vito Kasten Bj. 2014 → · Sprinter Bj. 2008 →
  - VOLKSWAGEN Crafter Bj. 2011 →
- Kosten- und Zeitersparnis durch Entfallen des Verbauens eines neuen Achsschenkels, der anschließenden Achsvermessung sowie dem damit verbundenen Mehraufwand
- Voraussetzung: Montageeinheit für Kompakt-Radlager V4491 sowie einer Antriebseinheit z.B. Hydraulik-Zylinder V4551 oder V2854
- Inklusive Multibox

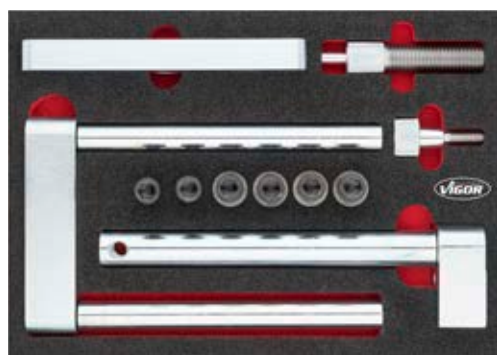
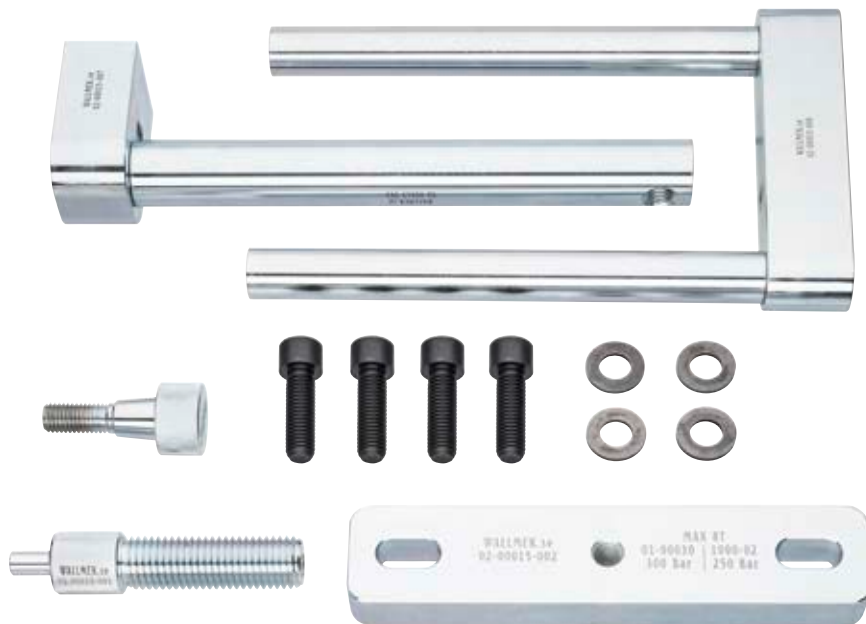

VIGOR No.	Bezeichnung	Ausführung	l mm	EAN 4047728+	€
V7133-2	Einpress-Gewinde mit Führung M24 · L 110 mm		110	071451	85,20
V7133-3	Einpress-Traverse CC = 160-186 mm · L 226 mm		-	071468	112,-
V7133-4	Einpress-Befestigung L 266 mm · M14 · M16		-	071475	111,50
V7133-5	Fixierschraube M14 konisch		-	071482	40,80
V7133-6	Einpress-Holme L 242 mm · 2x M14		-	071499	130,50
V7133-7	Einpress-Platte CC = 135-145 mm		-	071505	84,20
V7133-8	Befestigung Achsschenkel M14		-	071512	93,20
V7133-9	Gewindehülse 28x14,5x3 mm		-	071529	8,55
V7133-10	Gewindehülse M14x45 10,9		-	071536	10,70
V3056	Schraube · M 16x40 mm		-	030564	13,40



**1.138,50 €**  
zzgl. MwSt.



**V5741N**, EAN 4047728**070485**

## Längsstreben- und Querlenkerbuchsen Satz · FORD · Volvo · MAZDA

- Inklusive Multibox
- Querlenkerbuchsen Satz, für Hinterachsbuchsen
- Wechseln der Buchse (vordere Längsstrebe im hinteren Bereich) sowie der Hinterachsbuchse
- Für z.B.:
  - FORD Focus · Focus Turnier Bj. 1999 → · C-Max Bj. 2003 → · Kuga Bj. 2008 → · Galaxy Bj. 2006 → 2015 · Mondeo Bj. 2007 → 2015 · S-Max Bj. 2006 → 2014
  - Volvo V50 · S40 · C30 Bj. 2004 → · C70 Bj. 2006 → · S40 Bj. 2002 → 2012 · S60 · S80 Bj. 2010 → · V50 Bj. 2005 → 2012 · V60 Bj. 2010 → · V70 Bj. 2007 → 2015 · XC60 Bj. 2008 → · XC70 Bj. 2002 → 2007
  - MAZDA 3 Bj. 2003 → 2009 · 5 Bj. 2005 → 2010



VIGOR No.	Bezeichnung	Ausführung	EAN 4047728+	€
V3056	Schraube · M 16x40 mm		030564	13,40
V5902	Hinterachsbuchsen Satz		059022	404,50
V3649	Buchsen Satz Längsstrebe · FORD · Volvo		036498	392,50
V3053	Platte mit Gewinde		030533	235,50

**1.110,- €** zzgl. MwSt.



**V7154-4**, EAN 4047728071765

## Bremsscheiben Auspress Satz

- Inklusive Multibox
- Trennen von stark verrosteten und auf der Radnabe festsitzenden Bremsscheiben
- Starkes Hämmern auf die Bremsscheibe kann zur Radlagerbeschädigung führen
- Übertragung von gleichmäßigem Druck über die Auspress-Füße auf die Bremsscheibe. Hydraulik-Zylinder stützt sich mittels Adapterstück an Antriebswellen-Verschraubung ab
- Deutliche Minimierung des Beschädigungsrisikos durch gleichmäßige Kraftübertragung der vier Füße an die Bremsscheibe
- Empfehlung: Verwendung eines Hydraulik-Zylinders, z.B. V4551 oder V2854
- Alternative Anwendung mit V4699
- Spannweite: 260 – 330 mm
- Maximale Belastbarkeit: 22 t

M

2  
K

18t/22t

SUV  
Van

21



VIGOR No.	Bezeichnung	Ausführung	EAN 4047728+	€
V3871	Traverse für diverse Druckfüße		038713	268,50
V5904-4	Schraube · M 14 × 2 – 45 · Innensechskant		059145	13,-
V7154-1	Auspress Fuß · einzeln		071550	76,30
V7154-2	Fixierplatte · einzeln		071567	195,-
V5904-3	Gleitteller		059138	14,35



1.074,50 €

zzgl. MwSt.



**V5169**, EAN 4047728051699

## Zug und Druckhülsen Satz

- Inklusive Multibox
- Inklusive 24 Press-Stücke unterschiedlicher Größen
- Hülsen mit kurzen Größenabständen sind wendbar
- Adapter und Druckwelle ermöglichen Einsatz des Press-Bügels V2885 – praktisch beim Aus- und Einbau von Buchsen und Traggelenken ohne Löcher
- Größere Hülsen u.a. für BMW E 38 / E 39 und MERCEDES-BENZ E- /S-Klasse
- Fester Hülsensitz im Schaumstoff ermöglicht Wandmontage des Satz
- Multibox V4700-L
- Außenmaß: 464x335x142 mm
- Innenmaß: 400x300x80 mm

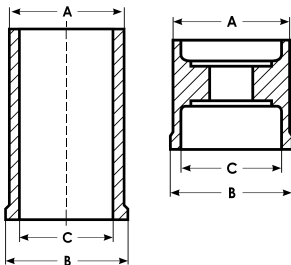

VIGOR No.	Bezeichnung	Ausführung	Ø A mm	Ø B mm	Ø C mm	EAN 4047728+	€
V2947	Presshülse		40.7	42.5	35.2	029476	43,75
V2948	Presshülse		43.7	45.5	38.2	029483	43,75
V2949	Presshülse		46.7	48.5	41.2	029490	57,40
V2950	Presshülse		49.7	51.5	44.2	029506	49,40
V2961	Presshülse		52.7	54.5	47.2	029612	49,40
V2962	Presshülse		55.7	57.5	50.2	029629	49,40
V2963	Presshülse		58.7	60.5	53.2	029636	49,40
V2964	Presshülse		61.7	63.5	56.2	029643	58,25
V2965	Presshülse		65.7	67.5	60.2	029650	58,25
V2966	Presshülse		69.7	71.5	64.2	029667	65,30
V2967	Pressrohr		38.7	44.7	30.5	029674	43,75
V2968	Pressrohr		41.7	44.7	34.0	029681	43,75
V2969	Pressrohr		44.7	44.7	37.2	029698	46,95
V2971	Pressrohr		47.7	55.0	40.2	029711	46,35
V2972	Pressrohr		50.7	55.0	43.2	029728	47,95
V2973	Pressrohr		53.7	55.0	46.2	029735	44,95
V2974	Pressrohr		56.7	55.0	49.2	029742	47,85



# Multiboxen



VIGOR No.	Bezeichnung	Ausführung	Ø A mm	Ø B mm	Ø C mm	EAN 4047728+	€
V2975	Pressrohr		59.7	70.0	52.2	029759	58,15
V2976	Pressrohr		62.7	70.0	55.2	029766	58,15
V2977	Pressrohr		65.7	70.0	58.2	029773	58,15
V2978	Pressrohr		68.8	70.0	61.2	029780	58,15
V2979	Pressrohr		71.7	70.0	64.2	029797	58,15
V2980	Pressrohr		75.7	75.7	68.2	029803	71,90
V2981	Pressrohr		79.7	79.7	72.2	029810	76,20
V2946	Druckstange · verstellbar · 90 mm für V2868		-	-	-	029469	69,75
V2945	Adapterplatte für V2868		-	-	-	029452	48,80



**826,- €**  
zzgl. MwSt.



**V8177**, EAN 4047728**081771**

## Zug- und Druckhülsen Satz

- Inklusive 17 Pressstücken in unterschiedlichen Durchmessern
- Durchmesser: 28,6 – 43,6 mm
- Hülsen sind beidseitig zu verwenden mit jeweils unterschiedlichen Durchmessern
- Universelles Aus- und Einpressen von Buchsen und Hülsen möglich
- Hülsensatz adaptierbar mit der Erweiterung V5169-A

**NEU**



VIGOR No.	Bezeichnung	Ausführung	Ø A mm	Ø B mm	Ø C mm	EAN 4047728+	€
V8177-28.6	Presshülse		27.5	28.6	22.6	081825	23,85
V8177-29.6	Presshülse		28.6	29.6	23.6	081832	23,85
V8177-30.6	Presshülse		29.6	30.6	24.6	081849	23,85
V8177-31.6	Presshülse		30.6	31.6	25.6	081856	23,85
V8177-32.6	Presshülse		31.6	32.6	26.5	081863	23,85
V8177-33.6	Presshülse		32.6	33.6	27.6	081870	28,65
V8177-34.6	Presshülse		33.6	34.6	28.6	081887	28,65
V8177-35.6	Presshülse		34.6	35.6	29.6	081894	28,65
V8177-36.6	Presshülse		35.6	36.6	30.6	081900	28,65
V8177-37.6	Presshülse		36.6	37.6	31.6	081917	28,65
V8177-38.6	Presshülse		37.6	38.6	32.6	081924	28,65
V8177-39.6	Presshülse		38.6	39.6	33.6	081931	28,65
V8177-40.6	Presshülse		39.6	40.6	34.6	081948	28,65
V8177-30	Pressrohr		38.0	44.7	30.0	081788	37,-
V8177-32	Pressrohr		40.0	44.7	32.0	081795	37,-
V8177-34	Pressrohr		42.0	44.7	34.0	081801	37,-
V8177-36	Pressrohr		44.0	44.7	36.0	081818	37,-

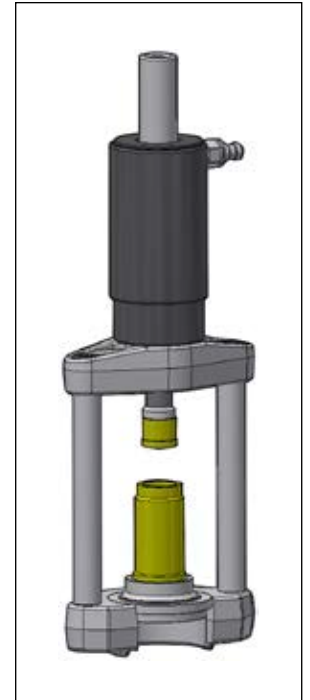

**476,- €**  
zzgl. MwSt.

**V5169-A**, EAN 4047728075381

## Druckhülsen-Erweiterungssatz

- Ausbau und Einbau von Lagern, Buchsen und Kugelgelenken
- Zur Erweiterung von Druckhülsen Satz V5169



VIGOR No.	Bezeichnung	Ausführung	EAN 4047728+	€
V5169-A45	Adapter Presshülsen · 45 mm		075398	57,25
V5169-A55	Adapter Presshülsen · 55 mm		075404	57,25
V5169-A70	Adapter Presshülsen · 70 mm		075411	57,25
V5169-A76	Adapter Presshülsen · 76 mm		075428	57,25
V5169-A80	Adapter Presshülsen · 80 mm		075435	57,25

**285,50 €**  
zzgl. MwSt.



**V2849**, EAN 4047728028493

## Antriebswellen-Auspressvorrichtung · 4- und 5-Loch

- Auspressen von verrosteten oder geklebten Antriebswellen direkt am Fahrzeug
- Für Pkw mit T4- und 5-Loch-Nabe durch ovale Löcher für Radschrauben
- Vermeidet Erwärmung, Beschädigung der Antriebswelle oder Schäden an anderen Teilen
- Anwendung:
  - Nabe mit Radschrauben des Fahrzeugs verschrauben
  - Antriebswelle mit 18 Tonnen oder 22 Tonnen Hydraulikzylinder auspressen. (Montage des Schlagkörpers ermöglicht zusätzliches Kraftaufbringen über Einsatz eines Hammers)
  - Herausziehen der Radnabe mit Schlagauszieher V2922 und Adapter V2872



**Arbeitsdauer nur ca. 5 Minuten**

VIGOR No.	Bezeichnung	Ausführung	EAN 4047728+	€
V3147	Antriebswelle 4-Loch · Lochkreis 92 – 120 mm		031479	399,-
V3148	Antriebswelle 5-Loch · Lochkreis 98 – 131 mm		031486	399,-

**616,50 €** zzgl. MwSt.

**V7862**, EAN 4047728078627

## Achswellen Demontage Satz

- Demontage der inneren Achswelle von der Getriebe-Einheit
- Durch das vollumfängliche Greifen der Achswelle werden Beschädigungen durch Hämmern oder Ziehen vermieden
- Variable Einstellungen des Achswellen-Halters ermöglichen optimalen Zugriff zur Welle
- Je nach Einbausituation kann der Halter in zwei Teile zerlegt und um die Achswelle gespannt werden
- Universell einstellbarer Halter ermöglicht Einsatz an Kleinwagen bis hin Nutzfahrzeugen
- Verwendung mit 5 kg Schlaghammer V2922

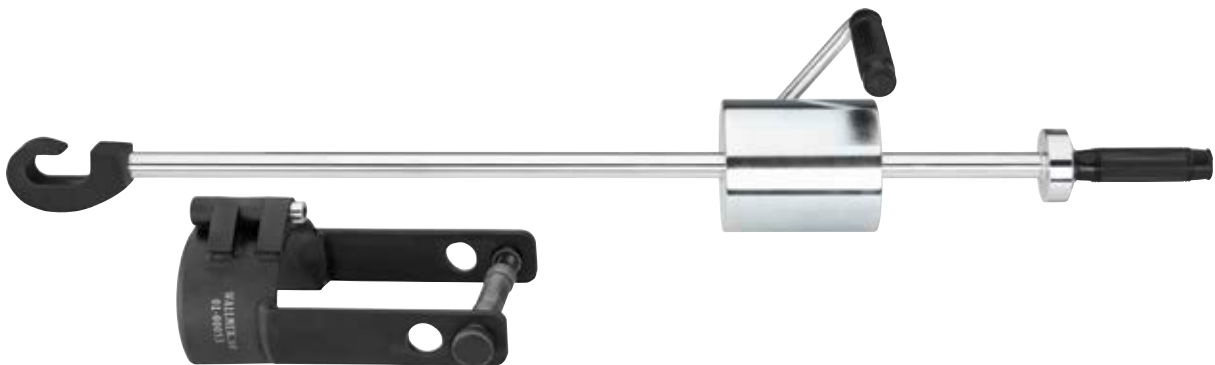

VIGOR No.	Bezeichnung	Ausführung	EAN 4047728+	€
V7980	Achswellen-Demontage Erweiterungssatz		079808	423,-
V2922	Schlaghammer 5,2 kg		029223	378,50

**741,- €** zzgl. MwSt.

# Antriebswelle



**V2922**, EAN 4047728029223

## Schlaghammer 5,2 kg

- Demontage Radnabe und Bremsscheibe
- Verwendung mit Radnaben Satz V2871 oder Adapter V2872 für Antriebswellen-Werkzeug V2849
- Ergonomischer Gleithammer



Innengewinde: M 18

**378,50 €**  
zzgl. MwSt.



**V2872**, EAN 4047728028721

## Adapter für Schlaghammer V2922

- Adapter zur Verwendung mit Schlaghammer (V2922) und Antriebswellen-Werkzeug (V2849) für Ausbau von Radnaben



Außengewinde: M 18

Außengewinde: 1 1/2"



**78,70 €**  
zzgl. MwSt.

**V2871**, EAN 4047728028714

## Radnaben Demontage Satz für V2922

- Radnaben Demontage mit Schlagwerkzeug V2922



VIGOR No.	Bezeichnung	Ausführung	L mm	EAN 4047728+	€
V3140	Zugstange M 18		150	031400	76,30
V3126	Kragenmutter · M 18x2,5		-	031264	47,95
V3036	Nabenscheibe Ø 52 mm · Innenloch-Ø 20,25 mm · passend für Spindel M 20		-	030366	27,60
V3035	Nabenscheibe Ø 45 mm · Innenloch-Ø 20,25 mm · passend für Spindel M 20		-	030359	21,90
V4598-2	Nabenscheibe · konisch · Ø 38,8 mm · für V4598		-	046152	27,30
V3033	Nabenscheibe Ø 32 mm · Innenloch-Ø 20,25 mm · passend für Spindel M 20		-	030335	17,45



**247,- €**  
zzgl. MwSt.



**V5916**, EAN 4047728059817

## Kugelgelenk-Ausdrücker · hydraulisch 4,5 Tonnen

- Hydraulisches Ausdrücken der Kugelgelenkzapfen an Spurstangen sowie Stabilisatoren mit maximaler Druckkraft von 4,5 Tonnen
- Höhenverstellung 60 und 72 mm sowie einstellbarer Durchmesser auf 26 und 32 mm
- Bauform optimiert Zugang zu schwer zugänglichen Stellen
- Werkzeug kann, mit Hilfe des mitgelieferten Distanzrings, in unterschiedliche Hublängen eingestellt werden
- Beidseitige Montage der Druckfüße um ebenfalls in beengten Platzverhältnissen arbeiten zu können
- Mitgelieferter Sicherheitsgurt verhindert das Herunterfallen des Werkzeugs nach dem Einsatz
- Betrieb mit Hydraulikpumpe V2846 und V2847 (700 bar)
- Speziell für moderne Aluminium Achsschenkel, bei denen konisch zulaufende Kegelschrauben verbaut sind

**4.5 t**

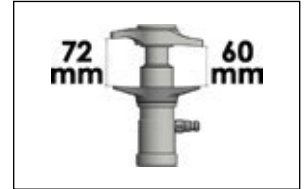

**925,- €**  
zzgl. MwSt.

**V5916-1**, EAN 4047728072953

## Kugelgelenk-Ausdrücker Erweiterung Pins

- Ausdrücken von Kugelgelenken sowie Spurstangen-Enden, mit Bolzen statt Mutterverschraubungen an der Kegelachse
- Pressplatten-Erweiterung für Kugelgelenk-Ausdrücker V5916
- Oberplatte kann individuell der Einbausituation angepasst und verstellt werden



**197,- €**  
zzgl. MwSt.

**V5916-2**, EAN 4047728073554

## Druckfuß-Erweiterung

- Für Kugelgelenkstifte mit Länge über 72 mm
- Anwendung an z.B. SUV und Nkw von CHEVROLET oder GMC
- Satz bestehend aus Presswerkzeug und Pressstück
- Betätigung mit hydraulischem Kugelgelenk-Ausdrücker V5916
- Auch in beengten Bauräumen einsetzbar



**135,- €**  
zzgl. MwSt.



**V5916-XL**, EAN 4047728066471

## Kugelgelenk-Ausdrücker · hydraulisch 8,8 Tonnen

- Hydraulisches Ausdrücken der Kugelgelenkzapfen an Spurstangen sowie Stabilisatoren, oder aber Lenk- und Bremshebel bei Lkw und Bussen, mit maximaler Druckkraft von 8,8 Tonnen
- Höhenverstellung 81 und 113 mm sowie einstellbarer Durchmesser auf 42 und 56 mm
- Bauform optimiert Zugang zu schwer erreichbaren Stellen
- Das Werkzeug kann, mit Hilfe der mitgelieferten Distanzringe, in unterschiedliche Hublängen eingestellt werden
- Beidseitige Montage der Druckfüße, um ebenfalls in beengten Platzverhältnissen arbeiten zu können
- Mitgelieferter Sicherheitsgurt verhindert das Herunterfallen des Werkzeugs nach dem Einsatz
- Betrieb mit Hydraulikpumpe V2846 · V2847 (700 bar)
- Speziell für moderne Aluminium Achsschenkel, bei denen konisch zulaufende Kegelschrauben verbaut sind
- $\pm$  7,0 kg

# 8.8 t



**1.350,- €**  
zzgl. MwSt.



**V2885**, EAN 4047728**028851**

## Press-Stativ mit offener Platte mit Adapter um Platte zu schließen

- Wechsel von Trag Gelenken und Hinterachsbuchsen
- Offene Press-Stativ Platte wird durch Adapter-Ring zur geschlossenen Platte
- Innendurchmesser der beiden Streben liegt bei 118 mm



VIGOR No.	Bezeichnung	Ausführung	mm	EAN 4047728+	€
V3053	Platte mit Gewinde		-	030533	235,50
V3055	Stützbein		185	030557	81,-
V3142	Adapterplatte		-	031424	54,45
V3056	Schraube · M 16x40 mm		-	030564	13,40
V3057	Platte mit offener Seite		-	030571	174,-

**392,50 €**  
zzgl. MwSt.

Tabelle mit Druckstücken für unterschiedliche Pkw

Typ	Druckstück	
BMW E30, E34 (innen)	V2906, V2905, V2904	
BMW E34 (außen)	V2909, V2908, V2907	
MERCEDES-BENZ Typ 124	V2906, V2905, V2902	
MERCEDES-BENZ Sprinter	V2901, V2900	
MERCEDES-BENZ Sprinter 2007 →	V2895, V2894, V2893	
DACIA Logan I (Bj. 2006 → 2013), RENAULT Clio 3 (Bj. 2006 → 2013), RENAULT Grand Scénic I (Bj. 2003 → 2009), RENAULT Laguna 1, RENAULT Mégane 2, RENAULT Modus (Bj. 2005 → 2013), RENAULT Scénic 2	V2906, V2892, V2891	
NISSAN Interstar, OPEL Movano, RENAULT Master	oben:	V2899, V2897
	unten:	V2903, V2899, V2898
VW T4	V2901, V2899	
VW LT35	V2901, V2900	
VW Crafter	V2895, V2894, V2893	
HYUNDAI Trajet, Santa Fé	V2898, V2896, V2892	

Tabelle mit Druckstücken und Preis

VIGOR No.	EAN 4047728+	€
V2891	028912	146,-
V2892	028929	146,-
V2893	028936	101,50
V2894	028943	174,-
V2895	028950	130,-
V2896	028967	126,-
V2897	028974	138,50
V2898	028981	126,-
V2899	028998	117,-
V2900	029001	117,-
V2901	029018	94,95
V2902	029025	146,-
V2903	029032	101,50
V2904	029049	130,-
V2905	029056	79,80
V2906	029063	79,80
V2907	029070	79,80
V2908	029087	74,70
V2909	029094	260,-



**V3055-275**, EAN 4047728076494

**Stützbein Satz · 275 mm**

- Verlängerung ermöglicht zusätzliche Anwendungen zum Pressen von Buchsen und Lagern
- In Verbindung mit Pressstativ V2885



**116,- €**  
zzgl. MwSt.



**V2912**, EAN 4047728029124

Querlenkerbuchsen Satz · hinten ·  
**FORD · MAZDA · Volvo**

- Für Hinterachsbuchsen – nur in Verbindung mit V2885 z.B. an:
  - FORD: Focus, Bj. 1999 → · C-Max, Bj. 2003 → · Kuga, Bj. 2008 → 2012
  - MAZDA: 3, Bj. 2003 → · 5, Bj. 2005 → 2001
  - Volvo: V50 · S40 · C30, Bj. 2004 → · C70, Bj. 2006 →



**453,- €**  
zzgl. MwSt.

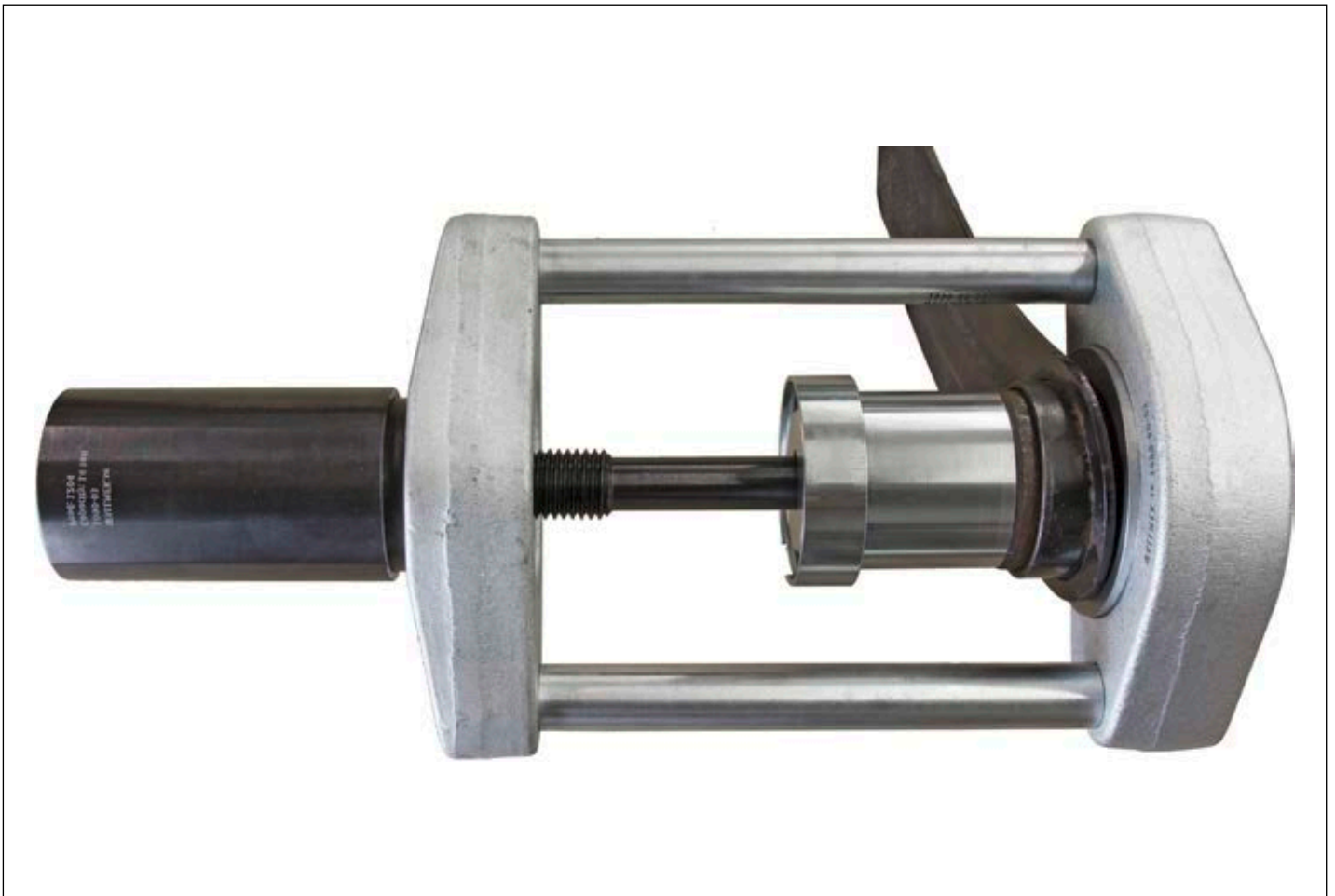

**V3649**, EAN 4047728**036498**

**Buchsen Satz Längsstrebe · FORD · Volvo**

- Austauschen der Buchse der vorderen Längsstrebe im hinteren Bereich
- Buchse und Pressrahmen nicht mehr als 16 Tonnen belasten
- Für z.B.:
  - FORD: Mondeo · Tourneo Bj. 2000 → 2007
  - FORD: Bj. 2007 →: Mondeo, S-Max, Galaxy
  - Volvo: Bj. 2007 →: S60 · S80 · V60 · V70 · XC60 · XC70



Zeitaufwand: 15 Minuten pro Wechsel



VIGOR No.	Bezeichnung	Ausführung	EAN 4047728+	€
V3650	Pressrahmen		036504	366,50
V3403	Druckrohr		034036	245,50
V3405	Adapterring		034050	144,50
V3404	Druckplatte		034043	144,50

Anwendung nur in Verbindung mit V3053 und V3056

**392,50 €** zzgl. MwSt.

**V3053**, EAN 4047728**030533**

**Platte mit Gewinde**

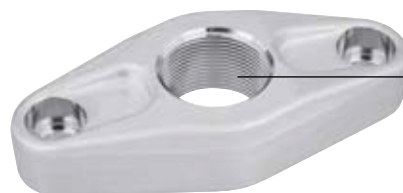

Innengewinde 1.1/2"

**235,50 €** zzgl. MwSt.

**V3056**, EAN 4047728**030564**

**Schraube · M 16 x 40 mm**



Preis pro Stück

**13,40 €** zzgl. MwSt.

## V2913, EAN 4047728029131

### Traggelenk Satz MERCEDES-BENZ

- Traggelenkwechsel
- MERCEDES-BENZ E-Klasse, Typ 211 · 219 · S-Klasse Typ 220 · SL-Klasse Typ 230
- Mit Traggelenk-Demontagehülse V2915 auch für MERCEDES-BENZ ML 163
- Nur einsetzbar in Verbindung mit Pressbügel (V2858N)



VIGOR No.	Bezeichnung	Ausführung	mm	EAN 4047728+	€
V3047	Druckhülse		-	030472	79,80
V3048	Montagehülse		-	030489	75,45
V3049	Demontagering		-	030496	84,80
V3129	Druckstück · verstellbar M 24		132	031295	86,95



**234,50 €**  
zzgl. MwSt.

## V2915, EAN 4047728029155

### Traggelenk-Demontagehülse MERCEDES-BENZ

- Für MERCEDES-BENZ ML 163
- Verwendung in Verbindung mit V2913
- Nur einsetzbar in Verbindung mit Pressbügel (V2858N)



**96,15 €**  
zzgl. MwSt.

## V2923, EAN 4047728029230

### Traggelenk Satz FORD

- Für FORD Transit
- Arbeiten direkt am Fahrzeug
- Zeitaufwand: 10 Minuten
- Nur einsetzbar in Verbindung mit Pressbügel (V2858N)

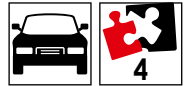

VIGOR No.	Bezeichnung	Ausführung	EAN 4047728+	€
V2999	Druckhülse		029995	164,50
V3000	Montage- / Demontagedeckel		030007	120,50
V3001	Montagehülse		030014	154,-
V3002	Demontagehülse		030021	120,50



**493,50 €**  
zzgl. MwSt.

## V2914, EAN 4047728029148

### Stabilisator-Kugelgelenk Satz MERCEDES-BENZ

- Für MERCEDES-BENZ: E-Klasse, Typ 211 und S-Klasse Typ 220
- Nur Ausbau des Stabilisators – kein Ausbau von Stoßdämpfer oder unteren Lenkerbefestigung erforderlich
- Nur einsetzbar in Verbindung mit Pressbügel (V2858N)



VIGOR No.	Bezeichnung	Ausführung	EAN 4047728+	€
V3045	Druckhülse		030458	79,80
V3046	Druckhülse		030465	79,80



**140,50 €**  
zzgl. MwSt.

## V2886, EAN 4047728028868

### Hinterachsbuchsen Satz VW · AUDI · SEAT · ŠKODA

- Demontage / Montage der Hinterachsbuchsen
- Für z.B.:
  - AUDI A3 (8L), Bj. 1997 → 2003 · TT (8N), Bj. 1999 → 2006
  - VW Beetle (1), Bj. 1998 → 2010 · Bora, Bj. 1998 → 2005 · Golf 4 Bj. 1997 → 2008 · Polo (4), Bj. 2002 → 2012
  - SEAT Ibiza (3), Bj. 2002 → 2009 · León (1), Bj. 1999 → 2006 · Toledo (2), Bj. 1999 → 2005
  - ŠKODA: Fabia (1), Bj. 2000 → 2008 · Octavia (1), Bj. 1998 → 2010 · Roomster, Bj. 2006 → · Rapid, Bj. 2012 →
- Nur in Verbindung mit V2885



Arbeitszeit: ca. 20 Minuten

VIGOR No.	Bezeichnung	Ausführung	EAN 4047728+	€
V3214	Montagehülse		032148	141,-
V3212	Demontagering		032124	225,50
V3213	Demontagehülse		032131	122,50
V3215	Montagering		032155	89,30

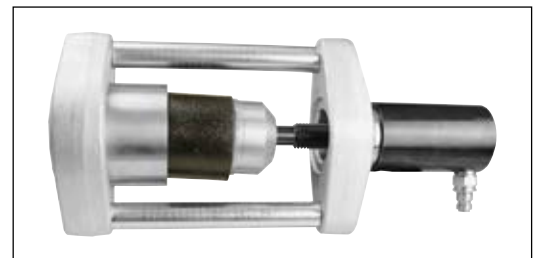

**525,50 €**  
zzgl. MwSt.

## V5902, EAN 4047728059022

### Hinterachsbuchsen Satz

- Für Hinterachsbuchsen z.B. an:
  - FORD Focus, Bj. 1999 → · Focus, Bj. 2018 → · C-Max, Bj. 2003 → · Kuga, Bj. 2008 →
  - MAZDA 3 Bj. 2003 → · 5 Bj. 2005 → 2011
  - Volvo V50 · S40 · C30 Bj. 2004 → · C70 Bj. 2006 →
- Nur in Verbindung mit V2885



VIGOR No.	Bezeichnung	Ausführung	EAN 4047728+	€
V3100	Demontage- / Montagehülse		031004	137,-
V3102	Gegenhalterring		031028	131,50
V3101	Montagescheibe		031011	116,50
V3103	Druckscheibe		031035	58,70
V5902-1	Montagehülse		059015	92,60
V5902-2	Haltering		059039	97,55

**404,50 €**  
zzgl. MwSt.



**V2917**, EAN 4047728**029179**

## Lenkerbuchsen Satz · hinten · MERCEDES-BENZ

- Demontage / Montage der hinteren / unteren Buchsen im Längslenker
- Für MERCEDES-BENZ: C-, E-, S-Klasse

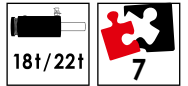

VIGOR No.	Bezeichnung	Ausführung	L mm	EAN 4047728+	€
V3052	Druckrohr		-	030526	109,-
V3136	Zugstange · M 14 · maximal 12 t		250	031363	56,85
V3135	Adapter · M 22x2,5 – M 14x2,0		-	031356	43,50
V3050	Demontagering		-	030502	82,75
V3051	Montagehülse		-	030519	84,80
V3044	Gegenhalterring Einbau		-	030441	93,75
V3137	Kragennutter · M 14x2,0		-	031370	43,50

**260,- €**  
zzgl. MwSt.

**V7393**, EAN 4047728**073936**

## Traggelenkbuchsen Satz BMW

- Austausch der unteren Achsschenkelbuchse bei diversen BMW Modellen
- Speziell konzipiertes Pressrohr ist für beengten Platzverhältnisse notwendig, um Anwendung mit Hydraulikzylinder direkt am Fahrzeug zu ermöglichen
- Für z.B.: BMW: 1er Bj. 2004→2019 · 2er Bj. 2012→2019 · 3er Bj. 2005→2019 · 4er Bj. 2012→2019 · X1 Bj. 2005→2015 · X3 Bj. 2009→2017 · X4 Bj. 2013→2018



**265,- €**  
zzgl. MwSt.



**V7865**, EAN 4047728**078658**

## Silentlager Buchsen Satz · VAG

- Demontage und Montage von Silentlagern an der Hinterachse diverser VAG Modelle
- Mithilfe der speziellen Halbschalen wird eine Passgenauigkeit auf die Buchse gewährleistet
- Für den Wechsel der Buchse an nachfolgenden Fahrzeugen:  
 VW Golf 7 Bj. 2017→ · Golf 7 Variant Bj. 2017→ · Golf 7 Sportsvan Bj. 2017→ · Golf 8 Bj. 2019→ · Polo 6 Bj. 2017→ · T-Cross Bj. 2018→ · T-Cross Bj. 2017→  
 AUDI A1 Bj. 2018→ · A3 Bj. 2017→ · Q2 Bj. 2017→  
 SEAT Arona Bj. 2017→ · Ateca Bj. 2016→ · Ibiza Bj. 2017→ · León Bj. 2018→



Demontage



Montage



Buchse



VIGOR No.	Bezeichnung	Ausführung	← L → mm	EAN 4047728+	€
<b>V7866</b>	Silentlager Hülse		-	078665	200,50
<b>V7867</b>	Silentlager Hülse		-	078672	87,45
<b>V7868</b>	Silentlager Halbschale		-	078689	157,-
<b>V7869</b>	Silentlager Hülse		-	078696	105,-
<b>V7870</b>	Silentlager Hülse		-	078702	71,55
<b>V3220</b>	Zugstange · M 12 · maximal 9 t		250	032209	43,75
<b>V3219</b>	Adapter · M 22x2,5 – M 12x1,75		-	032193	43,75
<b>V3208</b>	Kragenmutter · M 12x1,75		-	032087	38,10

**689,- €**  
zzgl. MwSt.



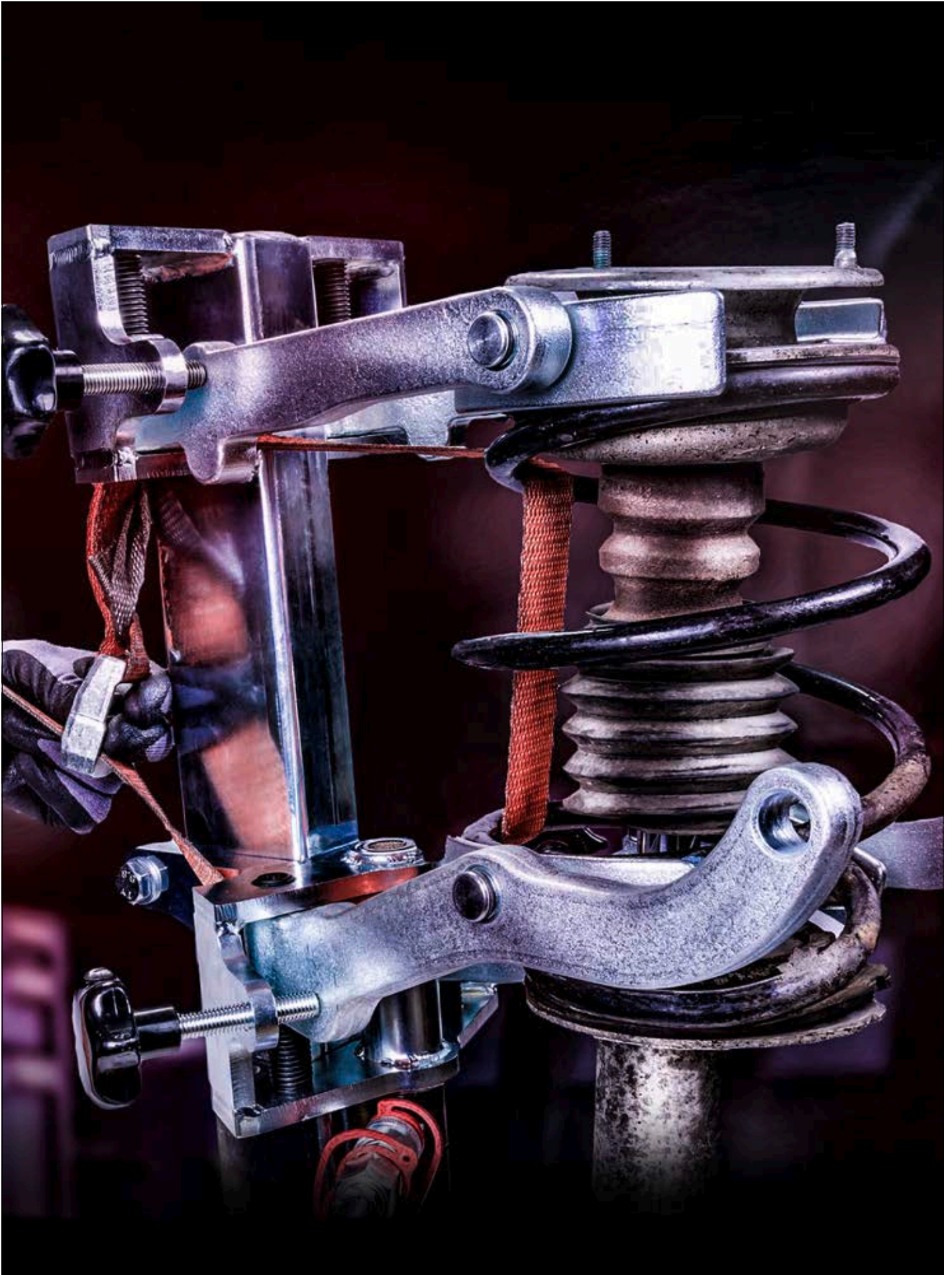

**V4476N**, EAN 4047728068000

## Hydraulischer Federspanner mit 10 Federteller

- Universal einsetzbar für fast alle Feder- und Stoßdämpferbeine im Bereich Pkw sowie leichten Transportern
- Auch für MERCEDES-BENZ C-Klasse (W203), neuere BMW- sowie VAG-Federbeine, bei denen eine elektronische Dämpfer-Verstellung verbaut ist (EDC, DCC)
- Durch das Greifen der Federn innerhalb der Federwindungen sind gegebenenfalls störende Bauteile am Stoßdämpfer irrelevant und haben keinen Einfluss auf die Funktionsweise des Federspanners
- Einsetzbar sowohl für links- als auch rechtsgewinkelte Federn
- Präzise Ausrichtung der Feder- und Stoßdämpferbeine
- Auch zur Trennung von Achsschenkeln und Federbeinen durch Entlastung des Federbeines direkt am Fahrzeug ohne Demontage der Achswelle, gegebenenfalls vorgeschriebene Achsvermessung entfällt
- Dreibein inklusive Rollen ermöglicht Verstauen und mobiles Arbeiten mit dem Federspanner – kein Platz auf einer Werkbank benötigt
- Umgekehrtes Aufsetzen des Stützrahmens zum Einsatz des Federspanners als zusätzliche hydraulische Stütze und kann mit 2,1 Tonnen Kraft verwendet werden, z.B. für Arbeiten an Lenkern oder Traggelenken
- Verwendung eines „Quick-Pin“ Mechanismus zum einfachen und schnellen Umbauen des Federspanners zur Nutzung der drei Funktionen: Greifen der Feder, Trennung von Achsschenkeln und Federbeinen sowie Einsatz als hydraulische Stütze
- Stabiler Dreibein-Fuß inklusive Arretierung und Positionierung für einen rutschfesten und waagerechten Stand
- Beim Spannen von alten Federn, bei denen ein Bruch wahrscheinlich ist, dient der robuste Sicherheitsriemen als zusätzlicher Sicherheitsaspekt
- Inklusive aller Federteller (4x V4352, 4x V4353 · 2x V4354)
- Hydraulikpumpe mit 700 bar Betriebsdruck wird zum Betätigen benötigt (V2846 / V2847)
- Gewicht: 44 kg
- Kapazität: 2,1 Tonnen
- Hub: 430 mm
- Federteller Ø 70 – 160 mm



**2.499,- €**  
zzgl. MwSt.



**V4476N-1**, EAN 4047728081597

## Federspanner Vorspanneinheit

- Schneller und effizienter Aus- und Einbau von MacPherson Federbeinen im eingebauten Zustand
- In Abhängigkeit des Federbeins, wird mithilfe der Pressbacken am unteren Federteller, oder der ersten Windung angelegt und gepresst
- Zum Trennen der Stoßdämpfer-Einheit aus dem Achsschenkel
- Das Lösen der Gelenkwelle, Spurstange oder Achslenker ist nicht notwendig
- Hydraulik-Pumpe V2846 oder V2847 wird benötigt



**NEU**



**1.599,- €**  
zzgl. MwSt.

**V4476N-2**, EAN 4047728081603

## Erweiterungssatz

- Zum Aufrüsten der Vorspann-Einheit V4476N-1 auf den vollständigen Federspanner V4476N



**NEU**

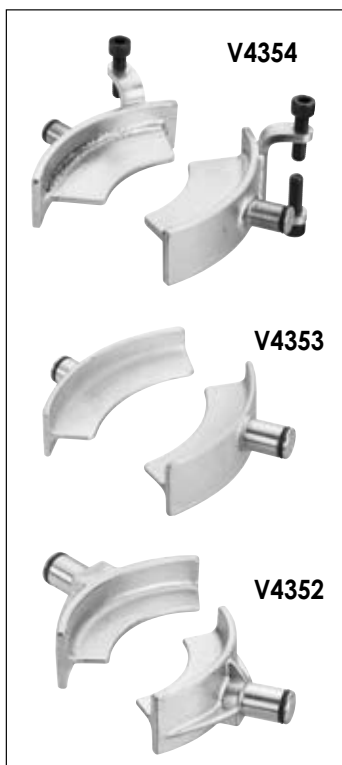

**1.499,- €**  
zzgl. MwSt.

**V4476-1**, EAN 4047728060264

**Adapter-Ring OPEL Insignia**

- Zur Verwendung mit VIGOR Federspanner V4476
- Zusätzlicher Adapterring wird benötigt bei Arbeiten für Federbeine folgender Fahrzeuge:
- OPEL Insignia B Bj. 2017 → 2019
  - Limousine Grand Sport
  - Kombi Sports Tourer



**94,95 €**  
zzgl. MwSt.



**V4352**, EAN 4047728043526

**Federteller Ø 70 – 160 mm**

- Federteller einzeln (es werden vier Federteller benötigt)
- Nur verwendbar mit Federspanner V4307



Preis pro Stück

**77,30 €**  
zzgl. MwSt.

**V4353**, EAN 4047728043533

**Federteller Ø 150 – 240 mm**

- Federteller einzeln (es werden vier Federteller benötigt)
- Nur verwendbar mit Federspanner V4307
- 4 Federteller im Federspanner Satz V4307 enthalten



Preis pro Stück

**54,45 €**  
zzgl. MwSt.

**V4354**, EAN 4047728043540

**Federteller Ø 150 – 240 mm mit Arretierung**

- Federteller einzeln (es werden vier Federteller benötigt)
- Nur verwendbar mit Federspanner V4307
- Speziell für CHRYSLER Voyager



Preis pro Stück

**158,50 €**  
zzgl. MwSt.



V7026, EAN 4047728070263

**VIGOR**  
SERIES **XL**

Mobile Werkbank mit Spezialwerkzeug Sortiment

• Lieferung ohne Fahrgriff

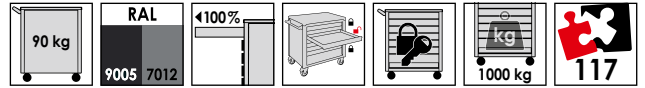

**+ Sortiment**

**7.774,- €**  
zzgl. MwSt.

# Mobile Werkbänke mit Spezialwerkzeug Sortiment



V7026-1, EAN 4047728070386



Mobile Werkbank mit Spezialwerkzeug Sortiment

• Lieferung ohne Fahrgriff

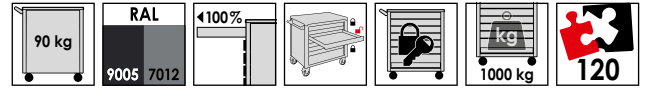

V7201



V4906N



V4921



V5549-1N



V4904

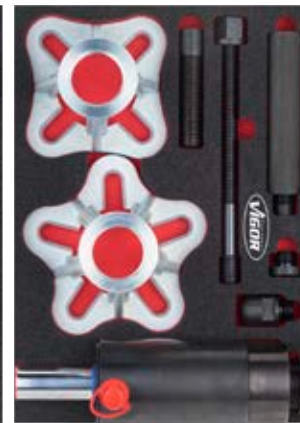

V4908



+ Sortiment



V5741N



V5066

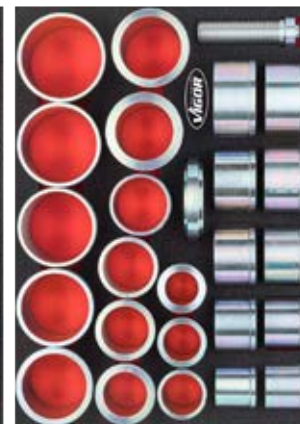

V5009



**8.145,- €**  
zzgl. MwSt.



V7026-2, EAN 4047728070478

**VIGOR**  
SERIES **XL**

Mobile Werkbank mit Spezialwerkzeug Sortiment

• Lieferung ohne Fahrgriff

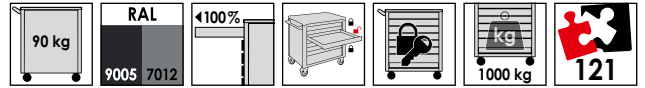

V7201



V4906N



V4921



V5549-1N



V4904



V4908



**+ Sortiment**

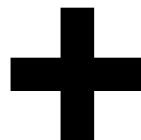

V5741N



V5066



V5009



**8.390,50 €**  
zzgl. MwSt.



# Mobile Werkbänke mit Spezialwerkzeug Sortiment



V7030, EAN 4047728077309



Mobile Werkbank mit Spezialwerkzeug Sortiment

• Lieferung ohne Fahrgriff

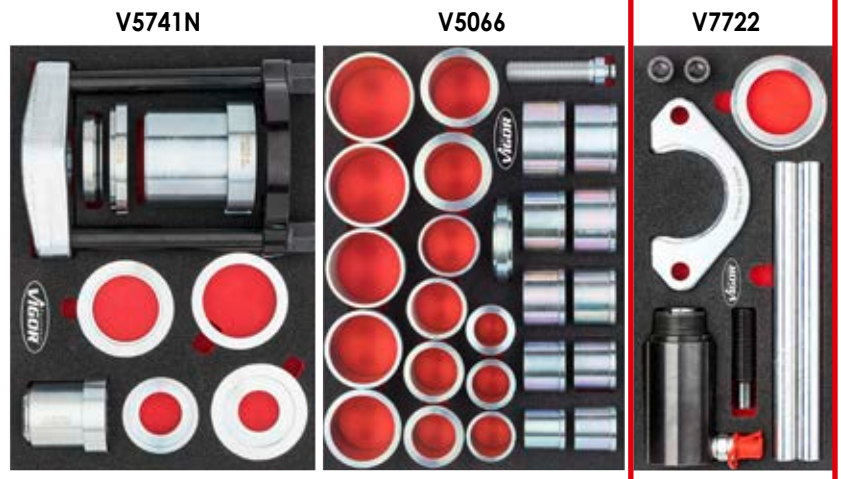
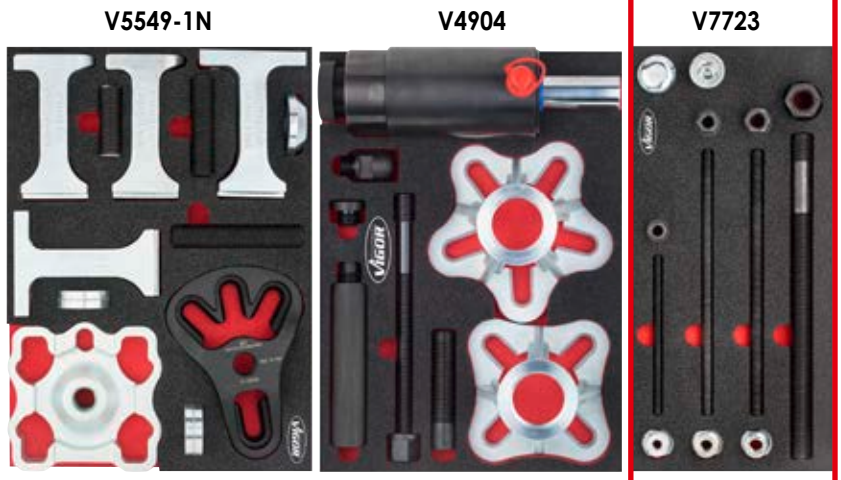
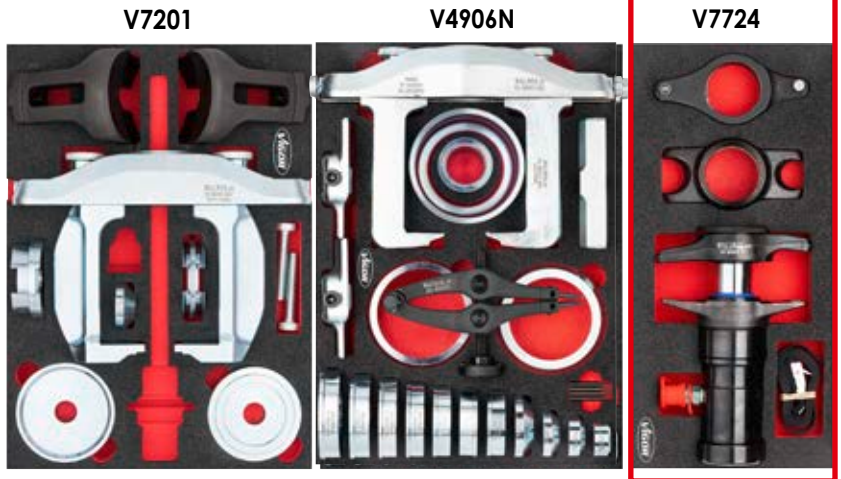
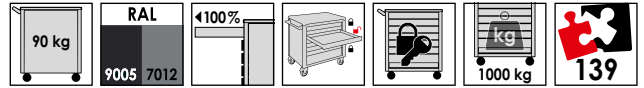

+ Sortiment

**10.599,- €**  
zzgl. MwSt.

V7030-2, EAN 4047728077323

**VIGOR**  
SERIES **XL**

Mobile Werkbank mit Spezialwerkzeug Sortiment

• Lieferung ohne Fahrgriff

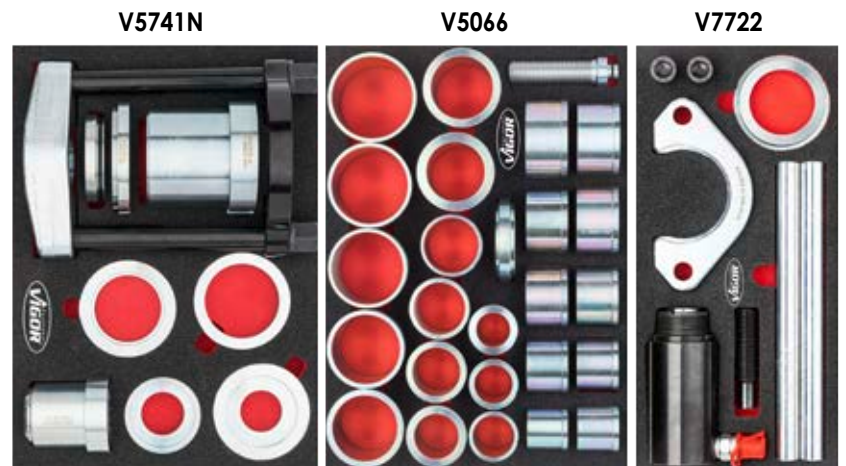
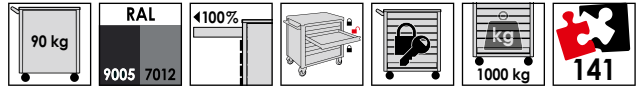

+ Sortiment

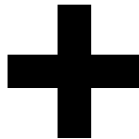

**11.200,- €**  
zzgl. MwSt.

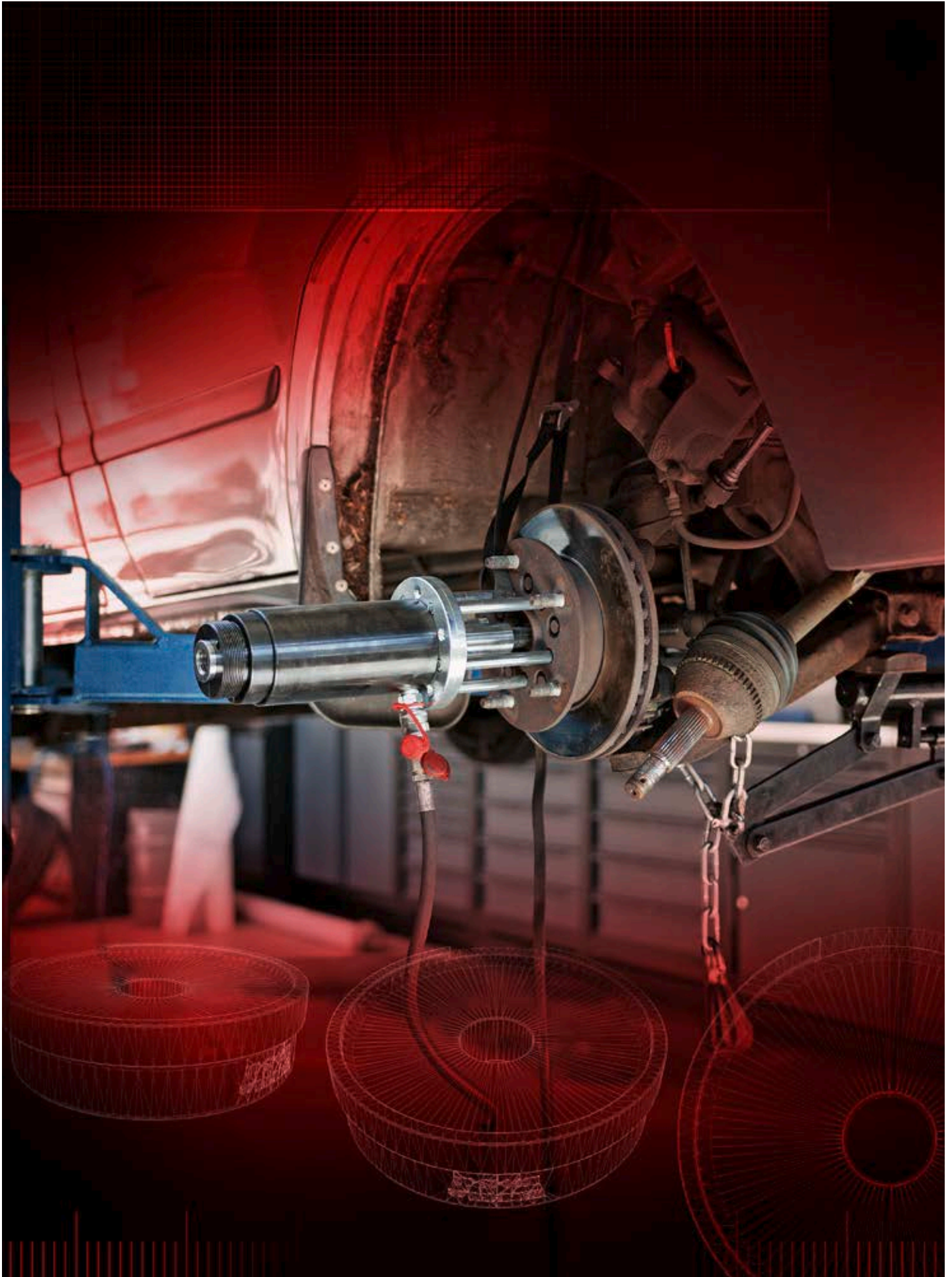

V7276, EAN 4047728072762

**VIGOR**  
SERIES **XL**

Mobile Werkbank mit Spezialwerkzeug Sortiment

• Lieferung ohne Fahrgriff

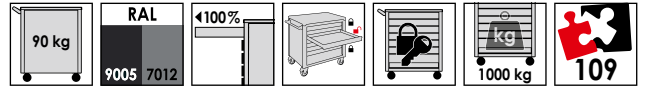

**+ Sortiment**

**10.599,- €**  
zzgl. MwSt.

# Mobile Werkbänke mit Spezialwerkzeug Sortiment



V7276-2, EAN 4047728072908



Mobile Werkbank mit Spezialwerkzeug Sortiment

• Lieferung ohne Fahrgriff

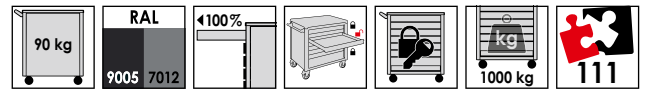

V7201



V7133N

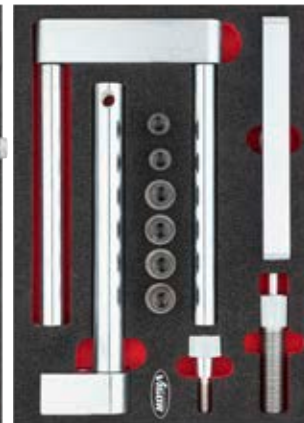

V5058



V7261



V7265



V7267



+ Sortiment

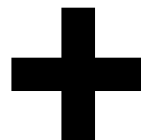

V7270



V7273



V7263



**11.341,- €**  
zzgl. MwSt.



V7280, EAN 4047728081955

**VIGOR SERIES XL**

Mobile Werkbank mit Spezialwerkzeug Sortiment

• Lieferung ohne Fahrgriff

**NEU**

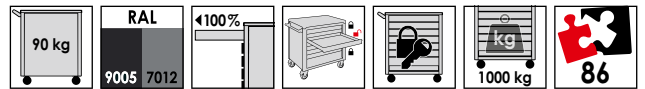

V7133N



V7261



V5009



V7265



V7270



V5009



**+ Sortiment**

V7273



V5018



V7263

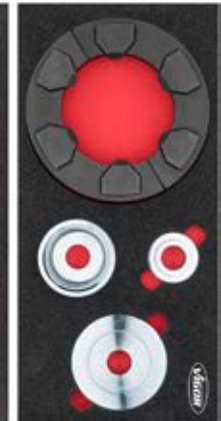

**8.479,- €**  
zzgl. MwSt.

## Erklärung der Piktogramme

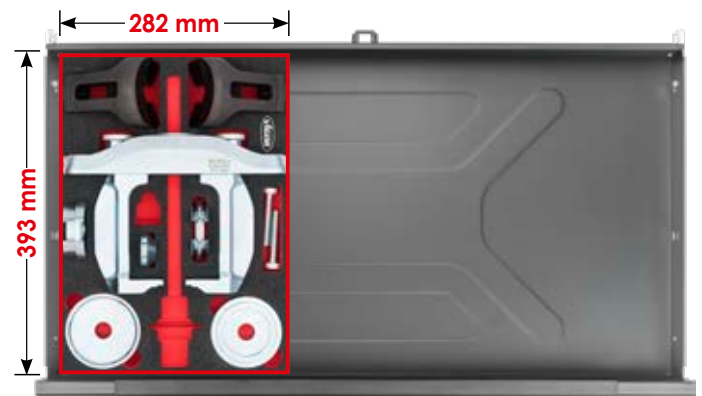
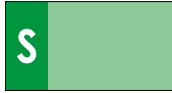



**V5064**, EAN 4047728050647  
 Druck- und Zug-Hydraulikzylinder 18 Tonnen

**1.025,50 €**  
zzgl. MwSt.



**V5058-L**, EAN 4047728050579  
 Weichschaum-Einlage · leer



**26,75 €**  
zzgl. MwSt.

**V5058**, EAN 4047728050586  
 Druck- und Zug-Hydraulikzylinder 22 Tonnen

**1.065,50 €**  
zzgl. MwSt.

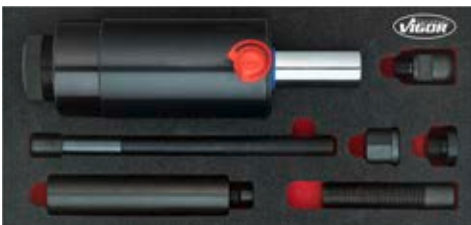

**V5085-L**, EAN 4047728050869  
 Weichschaum-Einlage · leer



**37,20 €**  
zzgl. MwSt.

**V4908**, EAN 4047728049085  
 Lager-Nabenschalen Satz mit Radlager-Fixierung

**467,50 €**  
zzgl. MwSt.



**V4908-L**, EAN 4047728049078  
 Weichschaum-Einlage · leer



**26,75 €**  
zzgl. MwSt.

**V4915**, EAN 4047728049153  
 Druckfuß Satz

**772,- €**  
zzgl. MwSt.



**V4915-L**, EAN 4047728049146  
 Weichschaum-Einlage · leer



**26,75 €**  
zzgl. MwSt.



# Spezial Weichschaum-Einlagen



**V5062**, EAN 4047728050623  
Antriebswellen-Werkzeug Satz

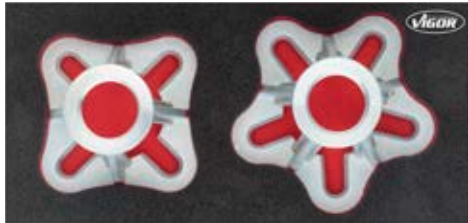

**652,- €**  
zzgl. MwSt.



**V5062-L**, EAN 4047728050616  
Weichschaum-Einlage · leer



**26,75 €**  
zzgl. MwSt.

**V4921**, EAN 4047728049214  
Lagerinnenring-Abzieher mit Sicherungsring-Werkzeug



**399,- €**  
zzgl. MwSt.



**V4921-L**, EAN 4047728049207  
Weichschaum-Einlage · leer



**26,75 €**  
zzgl. MwSt.

**V7263**, EAN 4047728072649  
Radlager Satz · vorne · IVECO Daily 2014  
• Austausch des vorderen Radlagers bei IVECO Daily Modellen Bj. 2014→



**531,50 €**  
zzgl. MwSt.



**V7263-L**, EAN 4047728072632  
Weichschaum-Einlage · leer

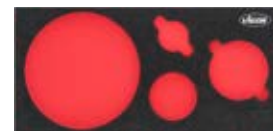

**26,75 €**  
zzgl. MwSt.

**V7267**, EAN 4047728072687  
Erweiterungssatz Naben / Radlager ziehen



**758,- €**  
zzgl. MwSt.



**V7267-L**, EAN 4047728072670  
Weichschaum-Einlage · leer



**26,75 €**  
zzgl. MwSt.

**V7722**, EAN 4047728077262  
Presstativ Erweiterung



**741,- €**  
zzgl. MwSt.



**V7722-L**, EAN 4047728077224  
Weichschaum-Einlage · leer



**26,75 €**  
zzgl. MwSt.



**V7723**, EAN 4047728077279

Spindel Satz

**667,- €**  
zzgl. MwSt.

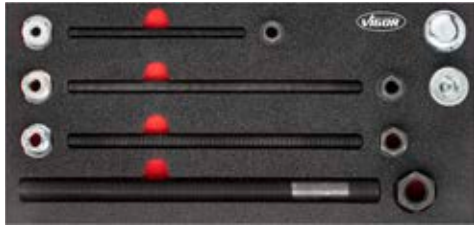
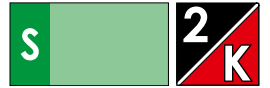

**V7723-L**, EAN 4047728077231

Weichschaum-Einlage · leer

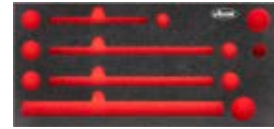

**26,75 €**  
zzgl. MwSt.

**V7724**, EAN 4047728077286

Kugelgelenk-Ausdrücker

**1.113,- €**  
zzgl. MwSt.



**V7724-L**, EAN 4047728080309

Weichschaum-Einlage · leer



**26,75 €**  
zzgl. MwSt.

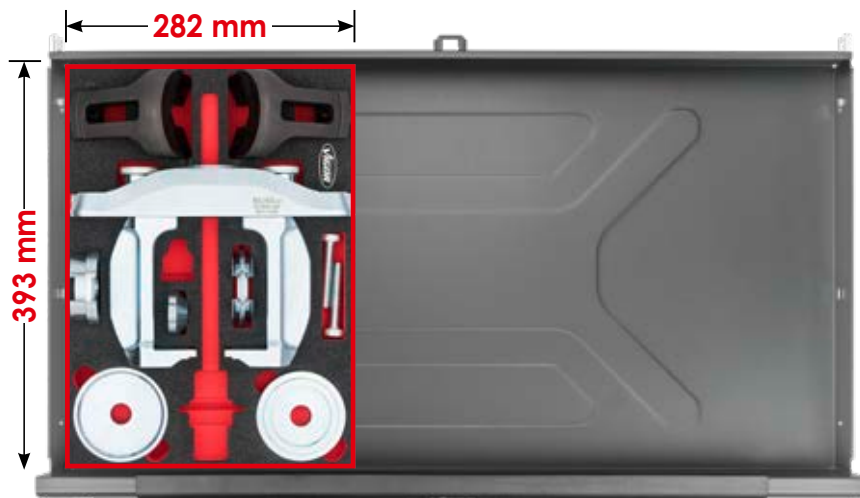

**V4906N**, EAN 4047728077255

Radlager Satz · Standard ·  
Demontage / Montage

**1.820,50 €**  
zzgl. MwSt.



**V4906N-L**, EAN 4047728077217

Weichschaum-Einlage · leer



**37,20 €**  
zzgl. MwSt.

# Spezial Weichschaum-Einlagen



**V7201**, EAN 4047728072014  
Kompakt-Radlager Demontage /  
Montage Satz · universal

**1.291,- €**  
zzgl. MwSt.



**V7201-L**, EAN 4047728072021  
Weichschaum-Einlage · leer

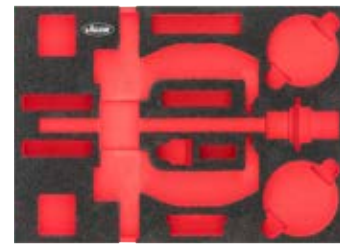

**37,20 €**  
zzgl. MwSt.

**V4904**, EAN 4047728049047  
Antriebswellen-Auspressvorrichtung Satz

**1.468,50 €**  
zzgl. MwSt.



**V4904-L**, EAN 4047728049023  
Weichschaum-Einlage · leer



**37,20 €**  
zzgl. MwSt.

**V5066**, EAN 4047728050661  
Zug- und Druckhülsen Satz

**776,50 €**  
zzgl. MwSt.



**V5066-L**, EAN 4047728050654  
Weichschaum-Einlage · leer



**37,20 €**  
zzgl. MwSt.



**V7261**, EAN 4047728072625

Transporter Werkzeuge Erweiterung Satz

**1.362,50 €**  
zzgl. MwSt.



**V7261-L**, EAN 4047728072618

Weichschaum-Einlage · leer



**37,20 €**  
zzgl. MwSt.

**V7265**, EAN 4047728072663

Zylinder Satz 32 Tonnen und 8,8 Tonnen

**2.529,50 €**  
zzgl. MwSt.



**V7265-L**, EAN 4047728072656

Weichschaum-Einlage · leer

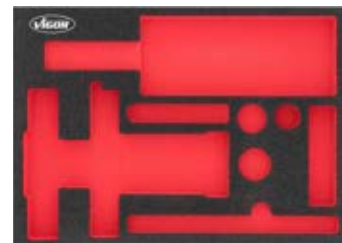

**37,20 €**  
zzgl. MwSt.

**V7270**, EAN 4047728072717

Hinterachse Erweiterungssatz

**1.264,50 €**  
zzgl. MwSt.



**V7270-L**, EAN 4047728072700

Weichschaum-Einlage · leer



**37,20 €**  
zzgl. MwSt.

# Spezial Weichschaum-Einlagen



**V7273**, EAN 4047728072748

## Transporter-Starter Satz

- Erhebliche Zeitersparnis durch Anwendung direkt am Fahrzeug · geschätzter Zeitaufwand pro Seite beträgt 30-40 Minuten

**1.999,- €**  
zzgl. MwSt.



**V7273-L**, EAN 4047728072731

## Weichschaum-Einlage · leer



**37,20 €**  
zzgl. MwSt.

**V5548**, EAN 4047728055482

## Kompakt-Radlager / -Nabe Erweiterungssatz

- Satz in Weichschaum-Einlage, ohne Multibox

**1.245,- €**  
zzgl. MwSt.



**V5548-L**, EAN 4047728055475

## Weichschaum-Einlage · leer

- Weichschaum-Einlage für V5548 · V549 · leer



**43,05 €**  
zzgl. MwSt.

**V7154**, EAN 4047728071543

## Bremsscheiben Auspress-Komplett Satz

**899,- €**  
zzgl. MwSt.



**V7154-L**, EAN 4047728071710

## Weichschaum-Einlage · leer



**61,40 €**  
zzgl. MwSt.



**V2889**, EAN 4047728028899

## Radlager Satz · vorne · CITROËN · FIAT · PEUGEOT

- Für z.B.:
  - CITROËN: Jumper Bj. → 2007
  - FIAT: Ducato Bj. → 2007
  - PEUGEOT: Boxer Bj. → 2007
- Radlagerwechsel direkt am Fahrzeug bei minimalen Zeitaufwand
- Demontage der Radnaben und Lager an dem Fahrwerk mit Hilfe des Hydraulikzylinder 32 Tonnen (V2874) in Verbindung mit Schlagkraft
- Arbeitszeit: 30–40 Minuten je Seite
- Nur einsetzbar in Verbindung mit Lagerscheibe (V2881) und Nabenscheibe (V2882)
- Für Modelle Bj. 2007 → muss Druckring V2883 verwendet werden



VIGOR No.	Bezeichnung	Ausführung	L mm	EAN 4047728+	€
V3105	Druckring		-	031059	264,50
V3107	Druckrohr		180	031073	326,-
V3149	Druckrohr		115	031493	63,35
V3091	Nabenscheibe · Innen-Ø 23 mm · passend für M 22 Spindel		-	030915	58,90
V3108	Lagerscheibe · Innen-Ø 23 mm · passend für M 22 Spindel		-	031080	170,-
V3109	Gegenhalter		-	031097	187,50
V3106	Druckscheibe Ø 170 mm		-	031066	239,50



**1.000,- €** zzgl. MwSt.

## Druckring für Radlager Satz · vorne · CITROËN · FIAT · PEUGEOT

- Ergänzungswerkzeug für z.B.:
  - CITROËN Jumper Bj. 2007 →
  - FIAT Ducato Bj. 2007 →
  - PEUGEOT Boxer Bj. 2007 →
- Für Fahrzeuge Bj. 2007 → – Einsatz mit V2889
- Statt Druckring Satz V3105, muss dieser Druckring Satz verwendet werden



VIGOR No.	EAN 4047728+	€
V2883	028837	399,-

## Lagerscheibe für Radlager Satz · vorne · CITROËN · FIAT · PEUGEOT

- Für Radlager Satz, vorne (V2889) benötigt, falls Radlager Satz, hinten (V2880) nicht vorhanden

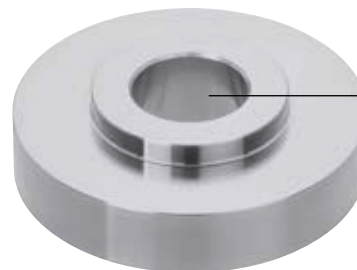

Innendurchmesser 23 mm

VIGOR No.	EAN 4047728+	€
V2881	028813	116,-

## Nabenscheibe für Radlager Satz · vorne · CITROËN · FIAT · PEUGEOT

- Für Radlager Satz, vorne (V2889) benötigt, falls Radlager Satz, hinten (V2880) nicht vorhanden

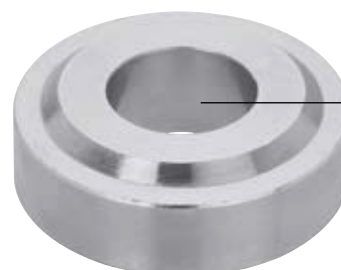

Innendurchmesser 23 mm

VIGOR No.	EAN 4047728+	€
V2882	028820	69,75

## Druckhülse

- Ergänzungswerkzeug für oben aufgeführte Modelle Bj. 2010 →
- Statt Lagerschale V3112 muss diese Druckhülse verwendet werden

VIGOR No.	EAN 4047728+	€
V3433	034333	185,-



## Druckring für Radlager Satz · vorne · CITROËN · FIAT · PEUGEOT

- Ergänzungswerkzeug für z.B.:
  - CITROËN Jumper Bj. 2007 →
  - FIAT Ducato Bj. 2007 →
  - PEUGEOT Boxer Bj. 2007 →
- Für Fahrzeuge Bj. 2007 → – Einsatz mit V2889
- Statt Druckring Satz V3105, muss dieser Druckring Satz verwendet werden

VIGOR No.	EAN 4047728+	€
V2883	028837	399,-



## V7252, EAN 4047728072526

### Radlager Satz · vorne · IVECO Daily 2014

- Austausch des vorderen Radlagers bei IVECO Daily Modellen Bj. 2014 →
- Erhebliche Zeitersparnis durch Verwendbarkeit direkt am Fahrzeug ohne vorherigen Ausbau der Achsteile circa 30 – 40 Minuten Arbeitsaufwand pro Seite
- Pressring für sicheren und verformungslosen Tausch des Radlagers konzipiert
- Verwendung des Satzes in Verbindung mit dem Hydraulikzylinder V2874
- Optional ist zusätzlich das Arbeiten unter der Werkstattpresse möglich



**915,- €**  
zzgl. MwSt.

## V2879, EAN 4047728028790

### Radlager Satz · vorne FORD

- Radlagerwechsel an Vorderachse
- Für FORD Transit (Tourneo) Bj. 2000 →
- Wechseln der Bremsscheibe ohne Zerstörung der Radlage
- Für Radlager mit 78 mm Ø und 87,5 mm Ø
- Arbeitszeit: ca. 25 Minuten je Seite
- Radlagerwechsel direkt am Fahrzeug bei minimalem Zeitaufwand



**678,- €**  
zzgl. MwSt.

**V2890**, EAN 4047728028905

## Antriebswellen-Werkzeug 5-Loch für Transportfahrzeuge

- Auspressen von verrosteten oder geklebten Antriebswellen direkt am Fahrzeug
- Für Transporter mit 5-Loch-Nabe durch exzentrische Löcher für Radschrauben
- Für Lochkreis 119 – 172 mm
- Vermeidet Erwärmung, Spaltung der Antriebswelle oder Schäden an anderen Teilen



Innengewinde 2. 1/2"



Arbeitsdauer nur  
ca. 5 Minuten

**664,50 €**  
zzgl. MwSt.

**V3287**, EAN 4047728032872

## Spezialmutter · M 16 x 1,5 mm

- In Verbindung mit dem Antriebswellenwerkzeug V2890 zur Demontage von Radlagern (hinten) oder zum Auspressen der Antriebswellen (vorn)
- Für
  - CITROËN Jumper
  - PEUGEOT Boxer
  - FIAT Ducato
  - RENAULT Master
- 5 Muttern erforderlich



Preis pro Stück

**55,75 €**  
zzgl. MwSt.

**V3013**, EAN 4047728030137

## Spezialmutter · M 14 x 2 mm

- In Verbindung mit dem Antriebswellenwerkzeug V2890 zur Demontage von Radlagern (hinten) oder zum Auspressen der Antriebswellen (vorn)
- Für FORD Transit
- 5 Muttern erforderlich



Preis pro Stück

**58,25 €**  
zzgl. MwSt.



**V7251**, EAN 4047728072540

## Multibox Radlager Satz IVECO Daily

- Austausch der Vorderachs-Radlager im eingebauten Zustand an IVECO Daily Bj. 2014 →
- Verwendung mit 32 t Hydraulikzylinder V2874
- Alternativer Einsatz auch im ausgebauten Zustand unter Zuhilfenahme einer Werkstattpresse



VIGOR No.	Bezeichnung	Ausführung	mm	EAN 4047728+	€
V7251-1	Druckring IVECO Daily		-	072557	333,50
V7251-2	Großes Druckrohr		-	072519	99,75
V7251-3	Lagerscheibe IVECO Daily		-	072564	56,95
V7251-4	Nabenscheibe IVECO Daily		-	072571	47,95
V7251-5	Lagerschale IVECO Daily		-	072588	68,40
V3106	Druckscheibe Ø 170 mm		-	031066	239,50
V3108	Lagerscheibe · Innen-Ø 23 mm · passend für M 22 Spindel		-	031080	170,-
V3149	Druckrohr		115	031493	63,35

**986,- €**  
zzgl. MwSt.



**V7275**, EAN 4047728**072755**

**Multibox · Starter Satz · Radlager  
Transporter Vorderachse**

• Erhebliche Zeitersparnis durch Anwendung  
direkt am Fahrzeug · geschätzter Zeitaufwand  
pro Seite beträgt 30-40 Minuten



VIGOR No.	Bezeichnung	Ausführung	← L → mm	EAN 4047728+	€
V3433	Druckhülse · Innen-Ø 23 mm · passend für M 22 Spindel		-	034333	185,-
V7251-2	Großes Druckrohr		-	072519	99,75
V3106	Druckscheibe Ø 170 mm		-	031066	239,50
V2883	Druckring für Radlager Satz · vorne · CITROËN · FIAT · PEUGEOT		-	028837	399,-
V2881	Lagerscheibe für CITROËN · FIAT · PEUGEOT Radlager Satz · vorne · Innen-Ø 23 mm · passend für M 22 Spindel		-	028813	116,-
V3108	Lagerscheibe · Innen-Ø 23 mm · passend für M 22 Spindel		-	031080	170,-
V3109	Gegenhalter		-	031097	187,50
V2882	Nabenscheibe für CITROËN · FIAT · PEUGEOT Radlager Satz · vorne		-	028820	69,75
V3149	Druckrohr		115	031493	63,35
V3091	Nabenscheibe · Innen-Ø 23 mm · passend für M 22 Spindel		-	030915	58,90
V3110	Druckscheibe · Ø 89 mm		-	031103	118,-
V3039	Druckscheibe · groß		-	030397	118,-
V3040	Druckrohr · groß		120	030403	192,50
V3087	Nabenwerkzeug		-	030878	528,50
V3088	Nabenscheibe · Innen-Ø 23 mm · passend für M 22 Spindel		-	030885	63,35



**2.061,- €**  
zzgl. MwSt.

# Werkzeugsätze Standard-Radlager



**V7291**, EAN 4047728072915

Multibox · Erweiterungssatz · Radlager  
Transporter Hinterachse / Antriebswelle



VIGOR No.	Bezeichnung	Ausführung	Ø	EAN 4047728+	€
V3013	Spezialmutter · M 14x2 mm		-	030137	58,25
V3287	Spezialmutter · M 16x1,5 mm		-	032872	55,75
V2890	Antriebswellen-Werkzeug 5-Loch für Transportfahrzeuge		-	028905	664,50
V3021	Druckhülse		105	030212	152,50
V3090	Adapterring		-	030908	160,-

**2.402,- €** zzgl. MwSt.



**V2858N**, EAN 4047728**075268**

## Pressbügel

- Maximale Belastung der Tragellenke und Pressbügel: 18 t
- Nur in Verbindung mit V2913 · V2915 · V2914
- Für z.B.: FORD und MERCEDES-BENZ

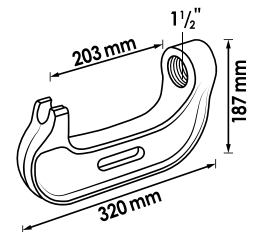

**342,- €**  
zzgl. MwSt.

**V2920**, EAN 4047728**029209**

## Kugelgelenk-Abzieher · universal

- Ausdrücken von Kugelgelenkzapfen aus Lenkhebel bei Transportern, Lkw und Bussen
- Schlanke Bauform – für Kugelgelenke MERCEDES-BENZ Sprinter und FORD Transit

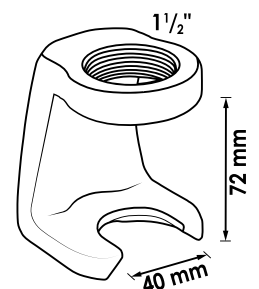

**360,- €**  
zzgl. MwSt.

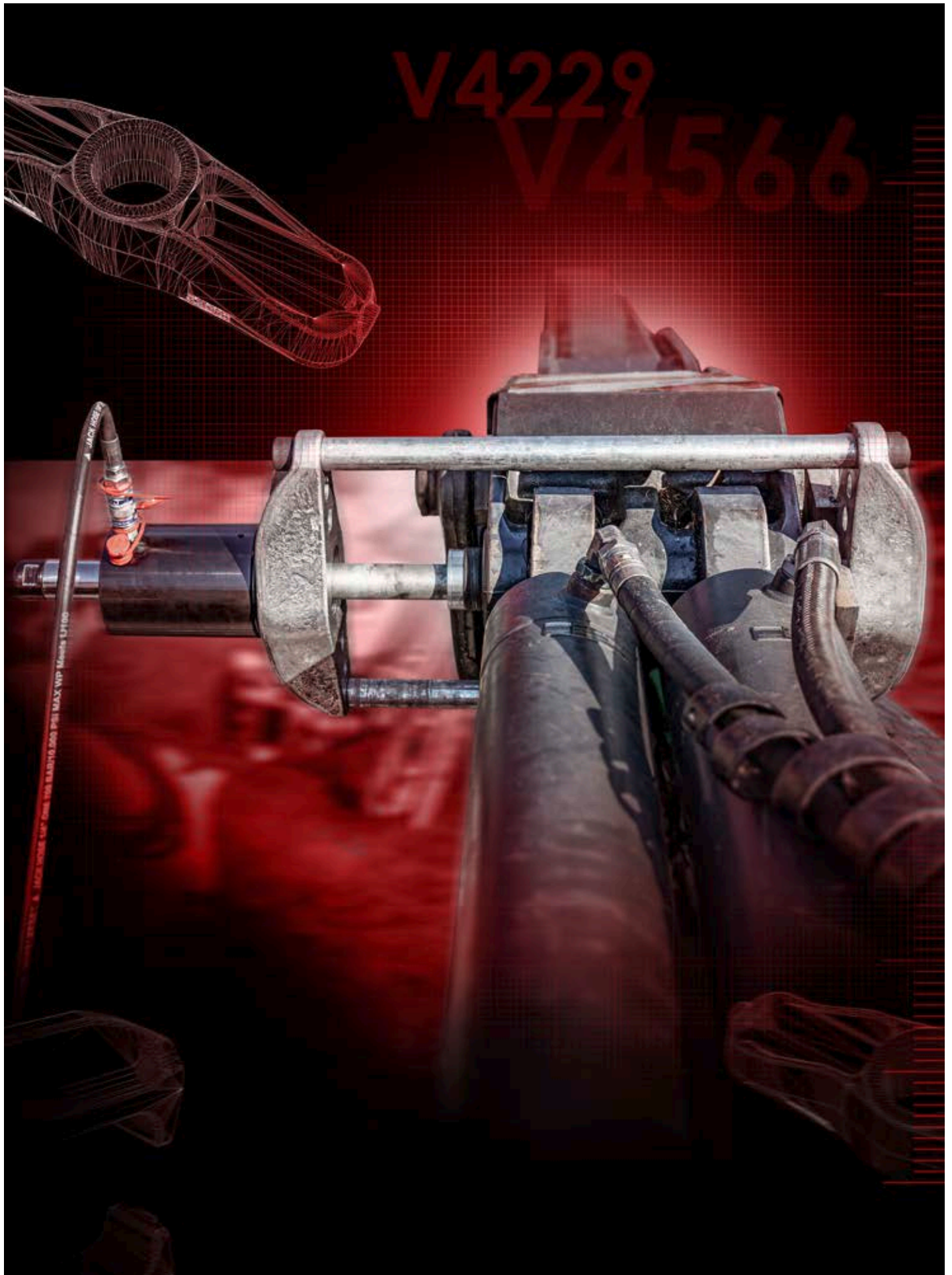

**V4565**, EAN 4047728**045650**

## Achsschenkelbolzen Demontage Satz 32 Tonnen · universal

- Für den Großteil der marktüblichen Achsschenkelbolzen, inklusive Varianten in konischer Form
- Einzigartige Schlagfunktion ermöglicht beim Ausbau Hammerschläge auf Zylinder (mit montiertem Schlagkörper) in Druckrichtung
- Schlagfunktion ist äußerst effektiv und überträgt die für erfolgreichen Ausbau entscheidenden Vibrationen auf das Material
- Kein Ausbau der Achse erforderlich
- 32 Tonnen Version
- Einfache Bedienung, auch für Busse, da bei diesen oft auf engstem Raum gearbeitet wird



Innengewinde 2.1/2"

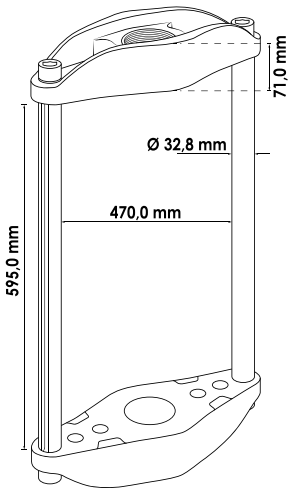

VIGOR No.	Bezeichnung	Ausführung	L mm	EAN 4047728+	€
V4550	Pressbügel für V4565 · V4566		-	045506	2.295,50
V3266	Druckrohr		130	032667	144,50
V4564	Druckrohr 85 mm für V4565 · V4566		85	045643	126,-
V3267	Druckrohr		42	032674	144,50
V4634	Druckrohr für V4565 · V4566		-	046343	126,-
V4562	Druckhülse für V4565 · V4566		-	045629	86,55
V4563	Adapterplatte für V4565 · V4566		-	045636	113,50
V3264	Druckstange · 250 mm Ø 31 mm		250	032643	286,-
V3265	Druckstange · 140 mm Ø 31 mm		140	032650	244,50
V3232	Druckstange · 50 mm Ø 31 mm		50	032322	132,50



**3.333,- €** zzgl. MwSt.

**V4566**, EAN 4047728**045667**

## Achsschenkelbolzen Demontage Satz 45 Tonnen · universal

- Für den Großteil der marktüblichen Achsschenkelbolzen, inklusive Varianten in konischer Form
- Einzigartige Schlagfunktion ermöglicht beim Ausbau Hammerschläge auf Zylinder (mit montiertem Schlagkörper) in Druckrichtung
- Schlagfunktion ist äußerst effektiv und überträgt die für erfolgreichen Ausbau entscheidenden Vibrationen auf das Material
- Kein Ausbau der Achse erforderlich
- 45 Tonnen Version
- Einfache Bedienung, auch für Busse, da bei diesen oft auf engstem Raum gearbeitet wird

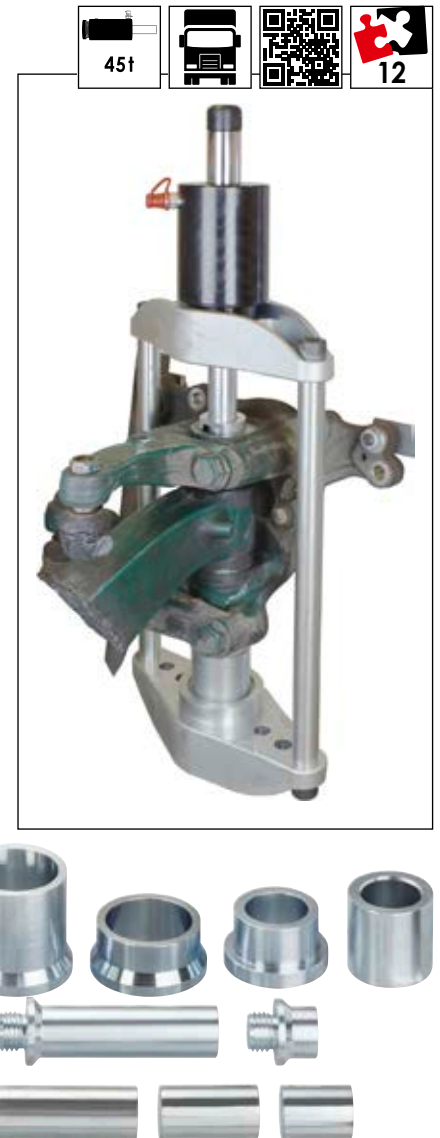
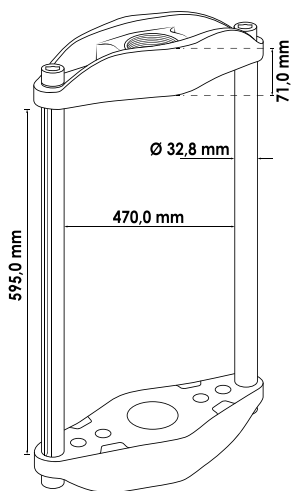

VIGOR No.	Bezeichnung	Ausführung	L mm	EAN 4047728+	€
V4550	Pressbügel für V4565 · V4566		-	045506	2.295,50
V3266	Druckrohr		130	032667	144,50
V4564	Druckrohr 85 mm für V4565 · V4566		85	045643	126,-
V3267	Druckrohr		42	032674	144,50
V4634	Druckrohr für V4565 · V4566		-	046343	126,-
V4562	Druckhülse für V4565 · V4566		-	045629	86,55
V4563	Adapterplatte für V4565 · V4566		-	045636	113,50
V4546	Druckstange · M 30 · Länge 140 mm · Ø 38 mm		140	045469	231,-
V4545	Druckstange · M 30 · Länge 30 mm · Ø 38 mm		30	045452	133,50
V4549	Verlängerung · 100 mm · Ø 38 mm für V4555 · V4566		100	045490	133,50
V4548	Verlängerung · 70 mm · Ø 38 mm für V4555 · V4566		70	045483	114,-
V4547	Verlängerung · 50 mm · Ø 38 mm für V4555 · V4566		50	045476	93,75



**3.253,- €** zzgl. MwSt.



## V4569, EAN 4047728045698

### Achsschenkelbolzen Demontage Erweiterungssatz

Erweiterungs Satz zu den Artikeln V4565 und V4566 System ermöglicht Aus- und Einpressen von Achsschenkelbolzen am Anhänger, ohne die Achse vorher auszubauen



VIGOR No.	Bezeichnung	Ausführung	EAN 4047728+	€
V4571	Verlängerung für V4569		045711	105,-
V4575	Verlängerung für V4569		045759	105,-
V4572	Verlängerung für V4569		045728	105,-
V4573	Pressplatte für V4569		045735	105,-
V4574	Pressplatte für V4569		045742	105,-
V4570	Stützbein für V4569		045704	208,50

**999,- €**  
zzgl. MwSt.

## V4605, EAN 4047728046053

### Achsschenkelbolzen Demontage Erweiterungssatz MERCEDES-BENZ Actros und Atego

Erweiterungs Satz zu den Artikeln V4565 und V4566 System ermöglicht Aus- und Einpressen von Achsschenkelbolzen direkt am Fahrzeug



VIGOR No.	Bezeichnung	Ausführung	l mm	EAN 4047728+	€
V4575	Verlängerung für V4569		-	045759	105,-*
V4609	Druckstange · M 30 · Länge 137 mm · Ø 29 mm · für V4605 · V602		137	046091	235,50
V4572	Verlängerung für V4569		-	045728	105,-
V4607	Führungsring für V4605 · V4606		-	046077	90,65
V4610	Zentrierdruckstück		-	046107	69,75

**700,- €**  
zzgl. MwSt.

\* Preis pro Stück

## V4606, EAN 4047728046060

### Achsschenkel Demontage Erweiterungssatz MAN TGA · TGX und TGS

Erweiterungs Satz zu den Artikeln V4565 und V4566 System ermöglicht Aus- und Einpressen von Achsschenkelbolzen direkt am Fahrzeug



VIGOR No.	Bezeichnung	Ausführung	EAN 4047728+	€
V4608	Druckrohr		046084	222,-
V4575	Verlängerung für V4569		045759	105,-*
V4572	Verlängerung für V4569		045728	105,-
V4607	Führungsring für V4605 · V4606		046077	90,65

**581,- €**  
zzgl. MwSt.

\* Preis pro Stück



## V4554, EAN 4047728045544

### Radnaben-Abzieher Satz Lkw · Busse und Anhänger 32 Tonnen

- Lkw-Radnaben mit 8 Bolzen 275 mm oder 10 Bolzen 335 mm
- Herauspressen von Radnaben mit Kompaktlagern wie z.B. bei SAF-Achsen
- Robuste Konstruktion ermöglicht volle Kraft von 32 Tonnen in Verbindung mit Schlagkraft beim Herauspressen



VIGOR No.	Bezeichnung	Ausführung	l mm	EAN 4047728+	€
V3263	Schraube · M 22x60 mm		-	032636	33,65
V4556	Platte mit Gewinde für V3750 · V4554 · V4555		-	045568	962,-
V3265	Druckstange · 140 mm Ø 31 mm		140	032650	244,50
V3232	Druckstange · 50 mm Ø 31 mm		50	032322	132,50
V3222	Druckfuß		-	032223	529,-
V3231	Pressplatte		-	032315	96,15
V3264	Druckstange · 250 mm Ø 31 mm		250	032643	286,-



**2.024,50 €** zzgl. MwSt.

## V4555, EAN 4047728045551

### Radnaben-Abzieher Satz Lkw · Busse und Anhänger 45 Tonnen

- Lkw-Radnaben mit 8 Bolzen 275 mm oder 10 Bolzen 335 mm
- Herauspressen von Radnaben mit Kompaktlagern wie z.B. bei SAF-Achsen
- Robuste Konstruktion ermöglicht volle Kraft von 45 Tonnen in Verbindung mit Schlagkraft beim Herauspressen



VIGOR No.	Bezeichnung	Ausführung	l mm	EAN 4047728+	€
V3263	Schraube · M 22x60 mm		-	032636	33,65
V4556	Platte mit Gewinde für V3750 · V4554 · V4555		-	045568	962,-
V3222	Druckfuß		-	032223	529,-
V4546	Druckstange · M 30 · Länge 140 mm · Ø 38 mm		140	045469	231,-
V4545	Druckstange · M 30 · Länge 30 mm · Ø 38 mm		30	045452	133,50
V4549	Verlängerung · 100 mm · Ø 38 mm für V4555 · V4566		100	045490	133,50
V4547	Verlängerung · 50 mm · Ø 38 mm für V4555 · V4566		50	045476	93,75
V4548	Verlängerung · 70 mm · Ø 38 mm für V4555 · V4566		70	045483	114,-

**2.024,50 €** zzgl. MwSt.



**V3634**, EAN 4047728**036344**

## Distanzschraube M 22

- Verwendung in Verbindung mit Radnaben-Abzieher Satz V2934 an Achsen mit Außenplanetengetriebe in der Radnabe
- Lieferung ohne abgebildete Platte (V2932)
- 4 Distanzschrauben zur Verwendung mit V2934 erforderlich
- Höhe: 50 mm



### Planetengetriebe



**72,50 €**  
zzgl. MwSt.

**V3434**, EAN 4047728**034340**

## Radlager Satz SCANIA

- Schneller, einfacher Wechsel des Radlagers direkt am Fahrzeug
- Nur in Verbindung mit Radnaben-Abzieher Satz V4554
- Enthaltene Schlagmutter ermöglicht beim Ausbau die Nutzung einer Schlagfunktion



*Nur in Verbindung mit  
Radnaben-Abzieher  
Satz V4554*



VIGOR No.	Bezeichnung	Ausführung	L mm	EAN 4047728+	€
V3431	Zugstange · M 22	—	500	034319	144,50
V3439	Schutzhülse		-	034395	130,-
V3440	Druckhülse		65	034401	86,95
V3437*	Druckscheibe · Ø 130 mm		-	034371	203,-
V3438*	Druckscheibe · Ø 125 mm		-	034388	203,-
V3132	Kragmutter · M 22x2,5		-	031325	65,30
V3092	Schlagmutter		-	030922	100,50



**758,- €**  
zzgl. MwSt.

\* Innendurchmesser 23 mm passend für M 22 Spindel

**V4499**, EAN 4047728**044998**

## Radnaben-Abzieher Nfz · 32 Tonnen

- Auspressen von festgerosteten Lagern mit außenliegenden Naben von geraden Wellen
- Für: Volvo FL · TGS · TGX · MERCEDES-BENZ Atego · Actros · RENAULT Kerax · Magnum · Midlum · Premium
- Kann ebenfalls für baugleiche Marken verwendet werden



VIGOR No.	Bezeichnung	Ausführung	EAN 4047728+	€
V3867	Adapter für Grundkörper mit Gewinde		038676	433,50
V3761	Grundkörper mit Gewinde		037617	555,50
V3762	Druckstange · M 24		037624	161,-

**1.000,- €** zzgl. MwSt.

**V4500**, EAN 4047728**045001**

## Radnaben-Abzieher Nfz · 45 Tonnen

- Auspressen von festgerosteten Lagern mit außenliegenden Naben von geraden Wellen
- Für: Volvo FL · TGS · TGX · MERCEDES-BENZ Atego · Actros · RENAULT Kerax · Magnum · Midlum · Premium
- Kann ebenfalls für baugleiche Marken verwendet werden



VIGOR No.	Bezeichnung	Ausführung	EAN 4047728+	€
V3867	Adapter für Grundkörper mit Gewinde		038676	433,50
V3761	Grundkörper mit Gewinde		037617	555,50
V4577	Druckstange · M 30 für V4500		045773	180,50

**1.000,- €** zzgl. MwSt.



## V3750, EAN 4047728037501

### Nabenabzieher für niedrig gebaute Anhänger

- Auspressen der 225 mm-Nabe mit 10 Schrauben
- Naben mit Einheitslager an geraden Wellen lassen sich dadurch lösen



VIGOR No.	Bezeichnung	Ausführung	EAN 4047728+	€
V3263	Schraube · M 22x60 mm		032636	33,65
V3763	Platte		037631	327,50
V3764	Schenkel		037648	133,50
V3765	Druckscheibe · SAF Ø 73 mm		037655	133,50

Nur in Verbindung mit  
Gewindeplatte V4556  
(nicht enthalten)

**1.202,50 €**  
zzgl. MwSt.

## V3678, EAN 4047728036788

### Bremsscheiben-Demontage (schwimmend gelagert) · Volvo · RENAULT · DAF

- Demontage von schwimmend gelagerten Bremsscheiben
- Abdrücken der Bremsscheibe durch wechselweises Drücken der Zylinder
- Zwei Spezialzylinder und Zweiwege-Steuerventile für wechselweises Pressen
- Nur wenige Minuten zum Abdrücken der Bremsscheibe

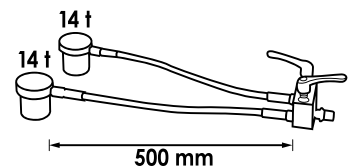

**1.734,- €**  
zzgl. MwSt.



## V4601, EAN 4047728046015

### Federbolzen Satz SCANIA 32 Tonnen

- Auspressen von Federbolzen
- Verwendung zusammen mit Platte V4556 für Pressbügel und 32 Tonnen Hydraulikzylinder V2874 (nicht enthalten)
- Bei festgerosteten Bolzen eingebaute Schlagfunktion verwenden (oftmals entscheidend für erfolgreichen Ausbau)
- Arbeit erfolgt direkt am Fahrzeug bei minimalem Teileausbau



VIGOR No.	Bezeichnung	Ausführung	mm	EAN 4047728+	€
V3262	Pressbügel		-	032629	1.390,50
V3259	Druckrohr · groß		60	032599	144,50
V3261	Druckstange · 115 mm Ø 29 mm		115	032612	216,50
V3263	Schraube · M 22x60 mm		-	032636	33,65*
V3260	Druckstange · 100 mm Ø 29 mm		100	032605	100,50

\* Preis pro Stück

**1.603,- €**  
zzgl. MwSt.

## V4602, EAN 4047728046022

### Federbolzen Satz SCANIA 45 Tonnen

- Auspressen von Federbolzen
- Verwendung zusammen mit Platte V4556 für Pressbügel und 45 Tonnen Hydraulikzylinder V4242 (nicht enthalten)
- Bei festgerosteten Bolzen eingebaute Schlagfunktion verwenden (oftmals entscheidend für erfolgreichen Ausbau)
- Arbeit erfolgt direkt am Fahrzeug bei minimalem Teileausbau



VIGOR No.	Bezeichnung	Ausführung	mm	EAN 4047728+	€
V3262	Pressbügel		-	032629	1.390,50
V3259	Druckrohr · groß		60	032599	144,50
V4609	Druckstange · M 30 · Länge 137 mm · Ø 29 mm · für V4605 · V602		137	046091	235,50
V3263	Schraube · M 22x60 mm		-	032636	33,65*
V4602-1	Druckstange Länge 64 mm Ø 29 mm		64	046336	208,50

\* Preis pro Stück

**1.603,- €**  
zzgl. MwSt.



**V2937**, EAN 4047728**029377**

## Abzieher Bremshebelarme

- Ausdrücken von festgerosteten Nockenwellen aus Bremshebelarmen
- Für fast alle marktüblichen Hebelarme, geeignet auch für Haldex und BPW
- Sehr kompakte Ausführung gewährleistet flexiblen Einsatz in engen Bereichen am Fahrzeug



Innengewinde 1.1/2"

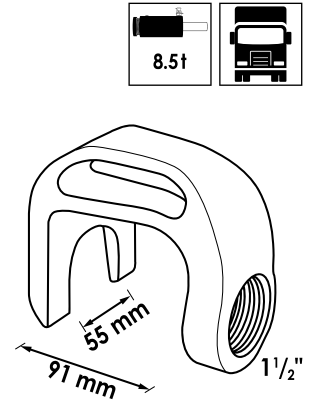

**519,- €**  
zzgl. MwSt.

**V4635**, EAN 4047728**046350**

## Federbuchsen Satz · universal

- Wechsel der Federbuchsen ohne unnötige Ausbauarbeiten
- Inklusive Werkzeugteile zum Auswechseln der Feder-Gelenkbuchse
- Für Buchsen der Größen 44 bis 63 mm
- Problemloses Entfernen selbst festgerosteter Buchsen dank Schlagfunktion



VIGOR No.	Bezeichnung	Ausführung	L mm	EAN 4047728+	€
<b>V3127</b>	Zugstange · M 18 – M 22 · maximal 22 t		250	031271	79,90
<b>V3126</b>	Kragenmutter · M 18x2,5		-	031264	47,95
<b>V3266</b>	Druckrohr		130	032667	144,50
<b>V3267</b>	Druckrohr		42	032674	144,50
<b>V3235*</b>	Druckscheibe · Ø 44 mm		-	032353	100,50
<b>V3236*</b>	Druckscheibe · Ø 50 mm		-	032360	100,50
<b>V3233*</b>	Druckscheibe · Ø 57 mm		-	032339	100,50
<b>V3237*</b>	Druckscheibe · Ø 63 mm		-	032377	109,50
<b>V3234*</b>	Druckscheibe · Ø 63 mm		-	032346	109,50

\* Innendurchmesser 23 mm passend für M 22 Spindel

**803,50 €**  
zzgl. MwSt.

## V2936, EAN 4047728029360

### Buchsen Satz · SAF-Achse · 150 mm

- Schnelle, einfache Demontage / Montage der großen Gummibuchsen 150 mm bei SAF-Achsen

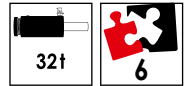

VIGOR No.	Bezeichnung	Ausführung	mm	EAN 4047728+	€
V3107	Druckrohr		180	031073	326,-
V3225	Demontage- / Montagering		-	032254	144,50
V3106*	Druckscheibe Ø 170 mm		-	031066	239,50
V3224*	Demontage- / Montagescheibe		-	032247	144,50
V3226	Montagering		-	032261	187,50
V3431	Zugstange · M 22		500	034319	144,50

\* Innendurchmesser 23 mm passend für M 22 Spindel

**823,- €**  
zzgl. MwSt.

## V2942, EAN 4047728029421

### Buchsen Satz für Deichseln

- Buchsenwechsel mit 32 Tonnen Hydraulikzylinder V2874 (nicht enthalten) mit Schlagfunktion direkt an der Deichsel
- Universell einsetzbar, insbesondere für Buchsen und Deichseln von V&G
- Buchsenwechsel ohne Erwärmung oder sonstige Bearbeitung

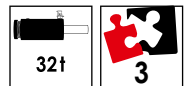

VIGOR No.	Bezeichnung	Ausführung	mm	EAN 4047728+	€
V3266	Druckrohr		130	032667	144,50
V3267	Druckrohr		42	032674	144,50
V3238*	Druckscheibe		-	032384	100,50

\* Innendurchmesser 23 mm passend für M 22 Spindel

**555,50 €**  
zzgl. MwSt.



**V4603**, EAN 4047728**046039**

## Druckwerkzeug Satz 32 Tonnen · universal

- Schneller Wechsel von konisch- und zylindrischen Achsschenkelbolzen, Federbuchsen und Deichselbolzen sowie großer Sicherungsringe
- Im Satz enthalten:
  - Demontagewerkzeuge für Kugelgelenke, Bremshebelarme, VB&G-Deichselbolzen
  - Werkzeuge zum Auspressen von Radnaben
  - 8,5 Tonnen und 32 Tonnen Hydraulikzylinder inklusive Spindel und Schlagkörper



VIGOR No.	Bezeichnung	Ausführung	mm	EAN 4047728+	€
V4565	Achsschenkelbolzen Demontage Satz 32 Tonnen · universal		-	045650	3.333,-
V5916-XL	Kugelgelenk-Ausdrücker · hydraulisch 8,8 Tonnen		-	066471	1.350,-
V2867N	Sicherungsring-Werkzeug		-	077859	190,-
V2874	Druck- und Zug-Hydraulikzylinder 32 Tonnen		223	028745	1.302,-
V3222	Druckfuß		-	032223	529,-

**7.805,50 €**  
zzgl. MwSt.



**V4604**, EAN 4047728**046046**

## Druckwerkzeug Satz 45 Tonnen · universal

- Schneller Wechsel von konisch- und zylindrischen Achsschenkelbolzen und Deichselbolzen sowie großer Sicherungsringe
- Im Satz enthalten:
  - Demontagewerkzeuge für Kugelgelenke, Bremshebelarme, VB&G-Deichselbolzen
  - Werkzeuge zum Auspressen von Radnaben
  - 8,5 Tonnen und 45 Tonnen Hydraulikzylinder inklusive Spindel und Schlagkörper



VIGOR No.	Bezeichnung	Ausführung	mm	EAN 4047728+	€
V4550	Pressbügel für V4565 · V4566		-	045506	2.295,50
V5916-XL	Kugelgelenk-Ausdrücker · hydraulisch 8,8 Tonnen		-	066471	1.350,-
V2867N	Sicherungsring-Werkzeug		-	077859	190,-
V2874	Druck- und Zug-Hydraulikzylinder 32 Tonnen		223	028745	1.302,-
V3222	Druckfuß		-	032223	529,-

**7.774,- €**  
zzgl. MwSt.



Wallmek-No	VIGOR No.	Bezeichnung	Seite
01-00001-001	V2945	Adapterplatte für V2868	361
01-00001-002	V2946	Druckstange · verstellbar · 90 mm für V2868	361
01-00001-101	V2947	Presshülse	360
01-00001-102	V2948	Presshülse	360
01-00001-103	V2949	Presshülse	360
01-00001-104	V2950	Presshülse	360
01-00001-105	V2961	Presshülse	360
01-00001-106	V2962	Presshülse	360
01-00001-107	V2963	Presshülse	360
01-00001-108	V2964	Presshülse	360
01-00001-109	V2965	Presshülse	360
01-00001-110	V2966	Presshülse	360
01-00001-201	V2967	Pressrohr	360
01-00001-202	V2968	Pressrohr	360
01-00001-203	V2969	Pressrohr	360
01-00001-204	V2971	Pressrohr	360
01-00001-205	V2972	Pressrohr	360
01-00001-206	V2973	Pressrohr	360
01-00001-207	V2974	Pressrohr	360
01-00001-208	V2975	Pressrohr	361
01-00001-209	V2976	Pressrohr	361
01-00001-210	V2977	Pressrohr	361
01-00001-211	V2978	Pressrohr	361
01-00001-212	V2979	Pressrohr	361
01-00001-213	V2980	Pressrohr	361
01-00001-214	V2981	Pressrohr	361
01-00001-400	V5169-A	Druckhülsen-Erweiterungssatz	363
01-00001-401	V5169-A45	Adapter Presshülsen · 45 mm	363
01-00001-402	V5169-A55	Adapter Presshülsen · 55 mm	363
01-00001-403	V5169-A70	Adapter Presshülsen · 70 mm	363
01-00001-404	V5169-A76	Adapter Presshülsen · 76 mm	363
01-00001-405	V5169-A80	Adapter Presshülsen · 80 mm	363
01-00001-500	V8177	Zug- und Druckhülsen Satz	362
01-00001-501	V8177-30	Pressrohr	362
01-00001-502	V8177-32	Pressrohr	362
01-00001-503	V8177-34	Pressrohr	362
01-00001-504	V8177-36	Pressrohr	362
01-00001-510	V8177-28.6	Presshülse	362
01-00001-511	V8177-29.6	Presshülse	362
01-00001-512	V8177-30.6	Presshülse	362
01-00001-513	V8177-31.6	Presshülse	362
01-00001-514	V8177-32.6	Presshülse	362
01-00001-515	V8177-33.6	Presshülse	362
01-00001-516	V8177-34.6	Presshülse	362
01-00001-517	V8177-35.6	Presshülse	362

Wallmek-No	VIGOR No.	Bezeichnung	Seite
01-00001-518	V8177-36.6	Presshülse	362
01-00001-519	V8177-37.6	Presshülse	362
01-00001-520	V8177-38.6	Presshülse	362
01-00001-521	V8177-39.6	Presshülse	362
01-00001-522	V8177-40.6	Presshülse	362
01-00001-999	V5066	Zug- und Druckhülsen Satz	393
01-00004	V2867N	Sicherungsring-Werkzeug	331, 414–415
01-00004-013	V2992	Stift Ø 2,5 mm	331
01-00004-014	V2993	Stift Ø 3,0 mm	331
01-00004-015	V2994	Stift Ø 3,5 mm	331
01-00018	V2860	Kompakt-Radlager Demontage Satz · universal	335, 351
01-00018-003	V3873	Fixierschraube · M 14	331, 335–336, 341, 343
01-00018-004	V3874	Schraube · M 12	331, 335–336, 341, 343
01-00020	V2853	Spindel Satz · mechanisch	330
01-00020-001	V3008	Zugstange mit Kragenmutter M 18	330
01-00020-002	V3206	Unterlegscheibe	330
01-00020-003	V3205	Druckscheibe	330
01-00022-003	V3403	Druckrohr	371
01-00022-004	V3404	Druckplatte	371
01-00022-005	V3405	Adapterring	371
01-00022-010	V3649	Buchsen Satz Längsstrebe · <b>FORD · Volvo</b>	358, 371
01-00022-020	V3650	Pressrahmen	371
01-00026	V3731	Demontage Satz, universal, für geschraubte Radlagereinheit	336
01-00026-020	V3758	Druckfuß Satz (Demontage) für geschraubte Radlagereinheiten	336, 348–349
01-00027	V3732	Demontage Satz, universal, für geschraubte Radlagereinheit	336
01-00027-020	V3753	Druckfuß Satz (Demontage) für geschraubte Radlagereinheiten	336, 348–349
01-00030	V4551	Druck- und Zug-Hydraulikzylinder 18 Tonnen	323
01-00030-001	V4552	Hydraulik-Zylinder · 18 Tonnen · ohne Zubehör	323
01-00030-005	V4553	Druckachse · M 24x3 mm	323
01-00031-018	V4342	Schlagmutter · M 18	328
01-00033	V4491	Kompakt-Radlager Montage Satz · universal	341
01-00033-020	V4493	Druckfuß (Paar) für Kompakt-Radlager-Montagewerkzeug Satz · universal	341
01-00033-110	V3680	Kompakt-Radlager Montage Satz · universal	351

# Umschlüsselung Wallmek / VIGOR



Wallmek-No	VIGOR No.	Bezeichnung	Seite
01-00033-200	V4491-A	Zentrierhilfe Kompaktradlager	341
01-00035	V4598	Radlager-, Antriebsachsen und Radnaben Satz · universal	332, 347
01-00035-001	V4614	Nabenscheibe · konisch · Ø 33,8 mm · für V4598	332, 348
01-00035-002	V4598-2	Nabenscheibe · konisch · Ø 38,8 mm · für V4598	332, 348, 365
01-00035-003	V4598-3	Nabenscheibe · konisch · Ø 43,8 mm · für V4598 · V4599	332, 334, 348
01-00035-004	V4598-4	Nabenscheibe · konisch · Ø 59,8 mm · für V4598	332, 348
01-00035-010	V4598-10	Lagerscheibe Ø 61,8 – 62,8 mm · Innenloch-Ø 20,25 mm · passend für Spindel M 20	332
01-00035-011	V4598-11	Lagerscheibe Ø 63,8 – 64,8 mm · Innenloch-Ø 20,25 mm · passend für Spindel M 20	332
01-00035-012	V4598-12	Lagerscheibe Ø 65,8 – 66,8 mm · Innenloch-Ø 20,25 mm · passend für Spindel M 20	332, 334
01-00035-013	V4598-13	Lagerscheibe Ø 68,8 – 70,8 mm · Innenloch-Ø 20,25 mm · passend für Spindel M 20	332
01-00035-014	V4598-14	Lagerscheibe Ø 72,5 – 74,5 mm · Innenloch-Ø 20,25 mm · passend für Spindel M 20	332
01-00035-015	V4598-15	Lagerscheibe Ø 76,5 – 78,5 mm · Innenloch-Ø 20,25 mm · passend für Spindel M 20	332
01-00035-016	V4598-16	Lagerscheibe Ø 80,8 – 82,8 mm · Innenloch-Ø 20,25 mm · passend für Spindel M 20	332
01-00035-020	V4598-20	Lagerschale Ø 93 mm für V4598	332
01-00035-021	V4598-21	Lagerschale Ø 75,5 mm für V4598	332
01-00035-022	V4598-22	Lagerschale Ø 93 mm für V4598	332
01-00035-030	V4598-30	Druckrohr Länge 78 mm für V4598 · V4599	332, 334, 348
01-00036	V4594	Radlager-Fixierung · verstellbar	334
01-00036-020	V4594-1	Druckfuß Satz für V4594	334
01-00037	V4629	Radnaben Demontage-Werkzeug · universal	331, 347
01-00037-020	V4629-1	Druckfuß Satz für V4629	331, 348
01-00038	V4599	Radlager Satz <b>AUDI</b> Q7 · <b>VW</b> Touareg · <b>PORSCHE</b> Cayenne	334
01-00039	V4699	Druckspindel Satz · manuell	330
01-00039-001	V4699-1	Druckspindel · M 30	330

Wallmek-No	VIGOR No.	Bezeichnung	Seite
01-00039-002	V4699-2	Adapter · 1.1/2" · M 30	330
01-00039-010	V4699-4	Press-Achse · 50xØ 19 mm	330
01-00039-011	V4699-5	Press-Achse · 85xØ 19 mm	330
01-00039-020	V4699-6	Press-Achse · 56xØ 24 mm	330
01-00039-021	V4699-7	Press-Achse · 100xØ 24 mm	330
01-00039-040	V4699-3	Scheibe Ø 18,8x3 mm (4 Stk.)	330
01-00040	V5027	Radnaben-Abzieher	342, 345, 349, 356
01-00041-002	V3871	Traverse für diverse Druckfüsse	331, 335–336, 341, 343, 345, 359
01-00041-003	V5904-3	Gleiteller	345, 359
01-00041-005	V5904-4	Schraube · M 14 x 2 – 45 · Innensechskant	345, 359
01-00041-005	V7133-10	Gewindehülse M14x45 10,9	357
01-00041-020	V3755	Druckfuß Satz (Demontage) für Kompakt-Radlager	335
01-00042-003	V5903-3	Zugstange · M 22 · 121 mm	340
01-00042-010	V7061	Schrauben Satz · <b>SUBARU</b> · Hinterradlager	340
01-00042-011	V7071	Schrauben Satz · <b>VAG</b>	340
01-00042-B	V5903N	Radlager-Abzieher für geschraubte Radlager	340, 349
01-00044	V5904	Antriebswellen-Auspressvorrichtung · 6- und 8-Loch	345
01-00044-030	V5904-1	Druckfuß Satz	345
01-00045	V5905	Radnaben- / Radlager-Abzieher · für 6 und 8 Bolzen	344–345, 356
01-00046	V5906	Radlagereinheit · geschraubt · Demontage Satz · universal	344–345
01-00046-020	V5906-1	Druckfuß Satz	343
01-00046-100	V7859	Radlager Demontage Satz · Steckachsen	345
01-00046-111	V7860	Abstützbacke	345
01-00047-020	V7050	Demontagewerkzeug für geschraubte 4-Loch Naben / Radlager mit unebenem Bremsenschutzblech	335
01-00048	V7154	Bremsscheiben Auspress-Komplett Satz	395
01-00048-001	V7154-1	Auspress Fuß · einzeln	359
01-00048-002	V7154-2	Fixierplatte · einzeln	359
01-00049	V7027	Radnaben- / Lagerabzieher	342
01-00050-010	V5422	Lagerplatte · Ø 85-95 mm	337
01-00050-011	V5423	Halteplatte · Ø 89-105 mm	338
01-00050-020	V5421	Erweiterungssatz · <b>ROVER</b>	337
01-00050-050	V5425	Standard Radlager Erweiterungssatz <b>ROVER</b>	337
01-00050-100	V5420	Standard Radlager Demontage / Montage Satz <b>ROVER</b>	337
01-00051	V7393	Traggelenkbuchsen Satz <b>BMW</b>	374
01-00053	V7862	Achswellen Demontage Satz	364

Wallmek-No	VIGOR No.	Bezeichnung	Seite
01-00053-100	V7980	Achswellen-Demontage Erweiterungssatz	364
01-00054	V7865	Silentlager Buchsen Satz · <b>VAG</b>	375
01-00054-002	V7867	Silentlager Hülse	375
01-00054-003	V7868	Silentlager Halbschale	375
01-00054-004	V7869	Silentlager Hülse	375
01-00054-005	V7870	Silentlager Hülse	375
02-00009	V2923	Traggelenk Satz <b>FORD</b>	372
02-00009-001	V2999	Druckhülse	372
02-00009-002	V3000	Montage- / Demontagedeckel	372
02-00009-003	V3001	Montagehülse	372
02-00009-004	V3002	Demontagehülse	372
02-00010-001	V3433	Druckhülse · Innen-Ø 23 mm · passend für M 22 Spindel	397, 400
02-00011	V7252	Radlager Satz · vorne · <b>IVECO</b> Daily 2014	397
02-00011-001	V7251-1	Druckring <b>IVECO</b> Daily	399
02-00011-002	V7251-2	Großes Druckrohr	399-400
02-00011-003	V7251-3	Lagerscheibe <b>IVECO</b> Daily	399
02-00011-004	V7251-4	Nabenscheibe <b>IVECO</b> Daily	399
02-00011-005	V7251-5	Lagerschale <b>IVECO</b> Daily	399
02-00015	V7133	Kompakt-Radlager Demontage / Montage Satz	356
02-00015-001	V7133-2	Einpress-Gewinde mit Führung M24 · L 110 mm	357
02-00015-002	V7133-3	Einpress-Traverse CC = 160-186 mm · L 226 mm	357
02-00015-003	V7133-4	Einpress-Befestigung L 266 mm · M14 · M16	357
02-00015-004	V7133-5	Fixierschraube M14 konisch	357
02-00015-005	V7133-6	Einpress-Holme L 242 mm · 2x M14	357
02-00015-006	V7133-7	Einpress-Platte CC = 135-145 mm	357
02-00015-007	V7133-8	Befestigung Achsschenkel M14	357
03-00003-005	V3263	Schraube · M 22x60 mm	407, 410-411
03-00004-001	V3262	Pressbügel	411
03-00005-001	V2937	Abzieher Bremshebelarme	412
03-00006-001	V3264	Druckstange · 250 mm Ø 31 mm	404, 407
03-00006-002	V3265	Druckstange · 140 mm Ø 31 mm	404, 407
03-00006-006	V3266	Druckrohr	404-405, 412-413
03-00006-007	V3267	Druckrohr	404-405, 412-413
03-00006-009	V3261	Druckstange · 115 mm Ø 29 mm	411
03-00006-010	V3260	Druckstange · 100 mm Ø 29 mm	411
03-00006-011	V3259	Druckrohr · groß	411
03-00006-013	V3238	Druckscheibe	413
03-00006-014	V3237	Druckscheibe · Ø 63 mm	412

Wallmek-No	VIGOR No.	Bezeichnung	Seite
03-00006-015	V3236	Druckscheibe · Ø 50 mm	412
03-00006-016	V3235	Druckscheibe · Ø 44 mm	412
03-00006-017	V3234	Druckscheibe · Ø 63 mm	412
03-00006-018	V3233	Druckscheibe · Ø 57 mm	412
03-00006-020	V3232	Druckstange · 50 mm Ø 31 mm	404, 407
03-00006-021	V3231	Pressplatte	407
03-00006-025	V3634	Distanzschraube M 22	408
03-00006-026	V3440	Druckhülse	408
03-00006-027	V4634	Druckrohr für V4565 · V4566	404-405
03-00006-028	V4563	Adapterplatte für V4565 · V4566	404-405
03-00006-029	V4564	Druckrohr 85 mm für V4565 · V4566	404-405
03-00006-030	V4562	Druckhülse für V4565 · V4566	404-405
03-00008-32T	V4601	Federbolzen Satz <b>SCANIA</b> 32 Tonnen	411
03-00008-45T	V4602	Federbolzen Satz <b>SCANIA</b> 45 Tonnen	411
03-00009	V4635	Federbuchsen Satz · universal	412
03-00010	V2942	Buchsen Satz für Deichseln	413
03-00013	V2936	Buchsen Satz · <b>SAF</b> -Achse · 150 mm	413
03-00013-001	V3226	Montagering	413
03-00013-002	V3225	Demontage- / Montagering	413
03-00013-003	V3224	Demontage- / Montagescheibe	413
03-00014-001	V2920	Kugelgelenk-Abzieher · universal	402
03-00015	V2873	Druck- und Zug-Hydraulikzylinder 8,5 Tonnen	322
03-00015-001	V3009	Hydraulik-Zylinder · 8,5 Tonnen	322
03-00015-006	V3010	Schlagkörper mit O-Ring	322
03-00015-012	V3011	Druckstange · verstellbar M 22	322
03-00016-020	V3222	Druckfuß	407, 414-415
03-00016-32T	V4554	Radnaben-Abzieher Satz Lkw · Busse und Anhänger 32 Tonnen	407
03-00016-45T	V4555	Radnaben-Abzieher Satz Lkw · Busse und Anhänger 45 Tonnen	407
03-00020	V3434	Radlager Satz <b>SCANIA</b>	408
03-00020-001	V3437	Druckscheibe · Ø 130 mm	408
03-00020-002	V3438	Druckscheibe · Ø 125 mm	408
03-00020-003	V3439	Schutzhülse	408
03-00021-020	V4603	Druckwerkzeug Satz 32 Tonnen · universal	414
03-00021-021	V4604	Druckwerkzeug Satz 45 Tonnen · universal	415
03-00022	V3750	Nabenabzieher für niedrig gebaute Anhänger	410
03-00022-001	V3763	Platte	410
03-00022-002	V3764	Schenkel	410
03-00022-003	V3765	Druckscheibe · <b>SAF</b> Ø 73 mm	410
03-00025	V3678	Bremsscheiben-Demontage (schwimmend gelagert) · <b>Volvo</b> · <b>RENAULT</b> · <b>DAF</b>	410

Wallmek-No	VIGOR No.	Bezeichnung	Seite
03-00026	V4229	Druck- und Zug-Hydraulikzylinder 45 Tonnen	324
03-00026-001	V4242	Hydraulik-Zylinder 45 Tonnen	324
03-00026-006	V4254	Schlagkörper · M 27	324
03-00026-012	V4251	Druckstück · verstellbar · M 30	324
03-00027-002	V3762	Druckstange · M 24	409
03-00027-003	V4577	Druckstange · M 30 für V4500	409
03-00027-010	V3761	Grundkörper mit Gewinde	409
03-00027-012	V3867	Adapter für Grundkörper mit Gewinde	409
03-00027-32T	V4499	Radnaben-Abzieher Nfz · 32 Tonnen	409
03-00027-45T	V4500	Radnaben-Abzieher Nfz · 45 Tonnen	409
03-00028	V2874	Druck- und Zug-Hydraulikzylinder 32 Tonnen	324, 414–415
03-00028-001	V3216	Hydraulik-Zylinder · 32 Tonnen	324
03-00031-001	V4550	Pressbügel für V4565 · V4566	404–405, 415
03-00031-002	V4556	Platte mit Gewinde für V3750 · V4554 · V4555	407
03-00031-200	V4569	Achsschenkelbolzen Demontage Erweiterungssatz	406
03-00031-201	V4570	Stützbein für V4569	406
03-00031-202	V4571	Verlängerung für V4569	406
03-00031-203	V4575	Verlängerung für V4569	406
03-00031-204	V4572	Verlängerung für V4569	406
03-00031-205	V4573	Pressplatte für V4569	406
03-00031-206	V4574	Pressplatte für V4569	406
03-00031-220	V4605	Achsschenkelbolzen Demontage Erweiterungssatz <b>MERCEDES-BENZ</b> Actros und Atego	406
03-00031-221	V4610	Zentrierdruckstück	406
03-00031-300	V4606	Achsschenkel Demontage Erweiterungssatz <b>MAN</b> TGA · TGX und TGS	406
03-00031-302	V4608	Druckrohr	406
03-00031-303	V4607	Führungsring für V4605 · V4606	406
03-00031-32T	V4565	Achsschenkelbolzen Demontage Satz 32 Tonnen · universal	404, 414
03-00031-45T	V4566	Achsschenkelbolzen Demontage Satz 45 Tonnen · universal	405
03-00032-001	V4545	Druckstange · M 30 · Länge 30 mm · Ø 38 mm	405, 407
03-00032-002	V4546	Druckstange · M 30 · Länge 140 mm · Ø 38 mm	405, 407
03-00032-003	V4547	Verlängerung · 50 mm · Ø 38 mm für V4555 · V4566	405, 407
03-00032-004	V4548	Verlängerung · 70 mm · Ø 38 mm für V4555 · V4566	405, 407

Wallmek-No	VIGOR No.	Bezeichnung	Seite
03-00032-005	V4549	Verlängerung · 100 mm · Ø 38 mm für V4555 · V4566	405, 407
03-00032-101	V4609	Druckstange · M 30 · Länge 137 mm · Ø 29 mm · für V4605 · V602	406, 411
03-00032-102	V4602-1	Druckstange Länge 64 mm Ø 29 mm	411
04-00003	V4255	Manometer	325
04-00007-001	V3287	Spezialmutter · M 16x1,5 mm	398, 401
04-00007-004	V3013	Spezialmutter · M 14x2 mm	398, 401
04-00015-001	V3582	Einklemmschutz	329
04-00016	V3612	Manometer	329
04-00020	V2800-OEL	Hydrauliköl Power	326
04-00021	V4218	Halterungs Satz für Hydraulik-Zylinder	326
04-00021-001	V4243	Halterung ohne Schelle	326
04-00021-013	V4244	Schelle Ø 70 mm	326
04-00021-014	V4245	Schelle Ø 85 mm	326
04-00021-015	V4246	Schelle Ø 100 mm	326
04-00024	V5916	Kugelgelenk-Ausdrücker · hydraulisch 4,5 Tonnen	366
04-00024-023	V5916-1	Kugelgelenk-Ausdrücker Erweiterung Pins	366
04-00024-024	V5916-2	Druckfuß-Erweiterung	366
04-00028	V5916-XL	Kugelgelenk-Ausdrücker · hydraulisch 8,8 Tonnen	355, 367, 414–415
09-000111	V7133-9	Gewindehülse 28x14,5x3 mm	357
1-1090-02	V3199	Hydraulik-Zylinder · 22 Tonnen	323
1-1090-03	V3217	Hydraulik-Zylinder · 14 Tonnen	322
1030	V2847	Hydraulische Fußpumpe	325, 352
1036	V2846	Hydraulikpumpe · pneumatisch	325, 353
1064	V2922	Schlaghammer 5,2 kg	364–365
1066	V2871	Radnaben Demontage Satz für V2922	365
1068	V2872	Adapter für Schlaghammer V2922	365
1068-04	V2851	Adapter für andere Werkzeugsysteme	327
1068-05	V2910	Adapter 1/2" auf G2-1/2" - 11	327
1068-06	V2850	Adapter für andere Werkzeugsysteme	326
1068-08	V3869	Adapter für andere Werkzeugsysteme	327
1068-09	V3870	Adapter für andere Werkzeugsysteme	327
1068-10	V4220	Adapter für andere Werkzeugsysteme	327
1086-6	V3018	Schlagkörper · M 22x2,5 mm	323–324
1090-02-WAL	V2854	Druck- und Zug-Hydraulikzylinder 22 Tonnen	323, 350, 352–353
1090-03	V2869	Druck-Hydraulikzylinder 14 Tonnen	322, 355
1090-15-B	V3021	Druckhülse	401
1090-20-02	V3033	Nabenscheibe Ø 32 mm · Innenloch-Ø 20,25 mm · passend für Spindel M 20	365

Wallmek-No	VIGOR No.	Bezeichnung	Seite
1090-20-06	V3035	Nabenscheibe Ø 45 mm · Innenloch-Ø 20,25 mm · passend für Spindel M 20	365
1090-20-08	V3036	Nabenscheibe Ø 52 mm · Innenloch-Ø 20,25 mm · passend für Spindel M 20	365
1090-20-M	V3060	Gegenhalter	332, 334
1090-20-T21	V3070	Lagerscheibe Ø 92 mm	334
1090-20-T22	V3071	Lagerscheibe Ø 95 mm · Innenloch-Ø 20,25 mm · passend · für Spindel M 20	334
1090-20-T22	V5424	Lagerplatte · Ø 95 mm	338
1090-25-10	V2864	Demontagescheibe · konisch · universal	335, 351
1090-25-11	V2861	Gegenhalteplatte (Montage) <b>VW · AUDI · SEAT · ŠKODA</b>	339
1090-25-12	V2862	Gegenhalteplatte (Montage) <b>VW</b>	339
1090-25-13	V2863	Montagering <b>FORD · MAZDA · Volvo</b>	339
1090-25-14	V2859	Gegenhalteplatte (Montage) <b>FORD · MAZDA · Volvo</b>	338
1090-25-15	V6824	Halbschalen Satz für die Montage von 92 mm Kompakt-Radlager	339
1090-25-16	V8180	Gegenhalteplatte Montage <b>VAG</b>	339
1090-26	V2845	Lager- und Nabenschale	333
1090-26-01	V3039	Druckscheibe · groß	333, 400
1090-26-02	V3040	Druckrohr · groß	333, 400
1090-30	V2849	Antriebswellen-Auspressvorrichtung · 4- und 5-Loch	350, 364
1090-30-4	V3147	Antriebswelle 4-Loch · Lochkreis 92 – 120 mm	364
1090-30-5	V3148	Antriebswelle 5-Loch · Lochkreis 98 – 131 mm	364
1090-32	V3207	Zugstangen-, Kragenmutter Adapter Satz	328
1090-39	V2886	Hinterachsbuchsen Satz <b>VW · AUDI · SEAT · ŠKODA</b>	373
1090-39-06	V3213	Demontagehülse	373
1090-39-08	V3214	Montagehülse	373
1090-39-09	V3215	Montagering	373
1090-39-10	V3212	Demontagering	373
1090-54-01	V3045	Druckhülse	372
1090-54-02	V3046	Druckhülse	372
1090-54-03	V3047	Druckhülse	372
1090-54-04	V3048	Montagehülse	372
1090-54-05	V3049	Demontagering	372
1090-54-06	V2915	Traggelenk-Demontagehülse <b>MERCEDES-BENZ</b>	372
1090-54-10	V2913	Traggelenk Satz <b>MERCEDES-BENZ</b>	372

Wallmek-No	VIGOR No.	Bezeichnung	Seite
1090-54-11	V2914	Stabilisator-Kugelgelenk Satz <b>MERCEDES-BENZ</b>	372
1090-54-12	V2917	Lenkerbuchsen Satz · hinten · <b>MERCEDES-BENZ</b>	374
1090-54-12-001	V3050	Demontagering	374
1090-54-12-002	V3051	Montagehülse	374
1090-54-12-003	V3052	Druckrohr	374
1090-54-12-004	V3044	Gegenhaltering Einbau	374
1090-55-C	V2858N	Pressbügel zum Wechsel von Traggelenken und Stabilisator-Kugelgelenken	402
1090-60-01	V3053	Platte mit Gewinde	358, 368, 371
1090-60-03	V3055	Stützbein	368
1090-60-04	V3056	Schraube · M 16x40 mm	357–358, 368, 371
1090-60-05	V3057	Platte mit offener Seite	368
1090-60-06	V3142	Adapterplatte	368
1090-60-10	V3055-275	Stützbein Satz · 275 mm	369
1090-61-01	V2909	Druckstück für Traggelenk-Werkzeug	369
1090-61-02	V2908	Druckstück für Traggelenk-Werkzeug	369
1090-61-03	V2907	Druckstück für Traggelenk-Werkzeug <b>BMW E 36</b> außen	369
1090-62-01	V2906	Druckstück für Traggelenk-Werkzeug <b>BMW E 30 · E 36</b> innen · <b>MERCEDES-BENZ 124</b>	369
1090-62-02	V2905	Druckstück für Traggelenk-Werkzeug <b>BMW E 30 · E 36</b> innen · <b>MERCEDES-BENZ 124</b>	369
1090-62-03	V2904	Druckstück für Traggelenk-Werkzeug <b>BMW E 30 · E 36</b> innen	369
1090-62-08	V2903	Druckstück für Traggelenk-Werkzeug	355, 369
1090-64-01	V2902	Druckstück für Traggelenk-Werkzeug z.B. <b>MERCEDES-BENZ 124</b>	369
1090-66-01	V2901	Druckstück für Traggelenk-Werkzeug	355, 369
1090-66-03	V2900	Druckstück für Traggelenk-Werkzeug <b>VW LT35</b>	355, 369
1090-66-04	V2899	Druckstück für Traggelenk-Werkzeug <b>NISSAN Interstar · OPEL Movano · RENAULT Master</b>	355, 369
1090-66-05	V2898	Druckstück für Traggelenk-Werkzeug <b>NISSAN Interstar · OPEL Movano · RENAULT Master · HYUNDAI Trajet · Santa Fé</b>	355, 369
1090-66-06	V2897	Druckstück für Traggelenk-Werkzeug	355, 369
1090-66-07	V2896	Druckstück für Traggelenk-Werkzeug	369
1090-66-08	V2895	Druckstück für Traggelenk-Werkzeug	355, 369
1090-66-09	V2894	Druckstück Traggelenk-Werkzeug (Ausbau)	355, 369
1090-66-10	V2893	Druckstück für Traggelenk-Werkzeug	355, 369
1090-68-01	V2892	Druckstück für Traggelenk-Werkzeug	369
1090-68-02	V2891	Druckstück für Traggelenk-Werkzeug	369

# Umschlüsselung Wallmek / VIGOR



Wallmek-No	VIGOR No.	Bezeichnung	Seite
1090-69-20-B	V2912	Querlenkerbuchsen Satz · hinten · <b>FORD · MAZDA · Volvo</b>	370
1090-69-20-B	V5902	Hinterachsbuchsen Satz	358, 373
1090-69-21	V3100	Demontage- / Montagehülse	373
1090-69-22	V3101	Montagescheibe	373
1090-69-23	V3102	Gegenhalterring	373
1090-69-24	V3103	Druckscheibe	373
1090-69-25	V5902-1	Montagehülse	373
1090-69-26	V5902-2	Halterring	373
1090-69   1090-60-06	V2885	Press-Stativ mit offener Platte mit Adapter um Platte zu schließen	355, 368
1091-10	V2879	Radlager Satz · vorne <b>FORD</b>	397
1091-10-04	V3088	Nabenscheibe · Innen-Ø 23 mm · passend für M 22 Spindel	400
1091-11	V3087	Nabenwerkzeug	400
1091-15-01	V3090	Adapterring	401
1091-17	V2889	Radlager Satz · vorne · <b>CITROËN · FIAT · PEUGEOT</b>	396
1091-17-01	V3105	Druckring	396
1091-17-02	V3106	Druckscheibe Ø 170 mm	396, 399–400, 413
1091-17-03	V3107	Druckrohr	396, 413
1091-17-04	V2881	Lagerscheibe für <b>CITROËN · FIAT · PEUGEOT</b> Radlager Satz · vorne · Innen-Ø 23 mm · passend für M 22 Spindel	396, 400
1091-17-05	V3108	Lagerscheibe · Innen-Ø 23 mm · passend für M 22 Spindel	396, 399–400
1091-17-06	V3109	Gegenhalter	396, 400
1091-17-07	V2882	Nabenscheibe für <b>CITROËN · FIAT · PEUGEOT</b> Radlager Satz · vorne	396, 400
1091-17-08	V3149	Druckrohr	396, 399–400
1091-17-09	V3091	Nabenscheibe · Innen-Ø 23 mm · passend für M 22 Spindel	396, 400
1091-17-M22	V3092	Schlagmutter	324, 408
1091-18	V2883	Druckring für Radlager Satz · vorne · <b>CITROËN · FIAT · PEUGEOT</b>	396–397, 400
1091-23-03	V3110	Druckscheibe · Ø 89 mm	400
1091-28	V2890	Antriebswellen-Werkzeug 5-Loch für Transportfahrzeuge	398, 401
HSC 2008-1119	V4476-1	Adapter-Ring <b>OPEL</b> Insignia	379
HSC2008-1116	V4353	Federteller Ø 150 – 240 mm	379
HSC2008-1117	V4352	Federteller Ø 70 – 160 mm	379
HSC2008-1118	V4354	Federteller Ø 150 – 240 mm mit Arretierung	379
HSC2018-050	V4476N-1	Federspanner Vorspanneinheit	378

Wallmek-No	VIGOR No.	Bezeichnung	Seite
HSC2018-051	V4476N-2	Erweiterungssatz	378
HSC2018-100	V4476N	Hydraulischer Federspanner mit 10 Federteller	377
RES 1030-01	V3614	Dichtungssatz	325
RES 1030-02	V3120	2,2 m Hydraulikschlauch ¼"	325
RES 1090-01-09	V3123	Druckfuß M 24x3 mm	323
RES 1090-01-10	V3124	Druckstange · verstellbar M 24	322–323
RES 1090-01-13	V3125	Schutzring für Gewinde 1.½"	323
RES 1090-02-04	V3134	Druckachse M 24x3 mm	323
RES 1090-05-02	V3130	Druckstück · verstellbar M 24	323–324
RES 1090-05-04	V3131	Schutzring für Gewinde 2,5	324
RES 4305	V3012	CEJN-Nippel Hydraulik · 1/8 Zoll	322
RES1090-01-12	V3129	Druckstück · verstellbar M 24	323, 355, 372
RES4009	V4596	Adapter · M 18 – M 22	328
RES4010	V3135	Adapter · M 22x2,5 – M 14x2,0	328, 374
RES4011	V3219	Adapter · M 22x2,5 – M 12x1,75	328, 375
RES4012	V3209	Adapter · M 22x2,5 – M 10x1,5	328
RES4014	V3210	Zugstange · M 10 · maximal 6 t	328
RES4015	V3220	Zugstange · M 12 · maximal 9 t	328, 375
RES4016	V3136	Zugstange · M 14 · maximal 12 t	328, 374
RES4021	V3137	Kragennutter · M 14x2,0	328, 374
RES4022	V3208	Kragennutter · M 12x1,75	328, 375
RES4023	V3275	Kragennutter · M 10x1,5	328
RES4024	V3126	Kragennutter · M 18x2,5	323, 328, 330, 365, 412
RES4025	V3132	Kragennutter · M 22x2,5	324, 328, 408
RES4026	V3127	Zugstange · M 18 M 22 · maximal 22 t	323, 328, 412
RES4027	V3133	Zugstange · M 22 · maximal 32 t	324, 328
RES4030	V3140	Zugstange M 18	365
RES4034	V3431	Zugstange · M 22	408, 413
RES4035	V4252	Kragennutter M 27	324
RES4036	V4253	Zugstange · M 27 · maximal 50 t	324
RES4039	V4597	Adapter · Innengewinde: M 22x2,5 mm · Außengewinde: M 27x3,0 mm	328
RES4042	V7699	Spindel M22 · M20	328
RES4043	V7700	Kragennutter M20	328
RES4304	V3141	(CEJN-) Schnellkupplung	325
RES4306	V3128	(CEJN-) Nippel Hydraulik ¼"	322–324
RES4307	V6591	Adapter 3/8" Außengewinde · auf CEJN / Zylinder	329
RES4308	V6592	Adapter 3/8" Innengewinde · auf CEJN / Pumpe	329







VIGOR



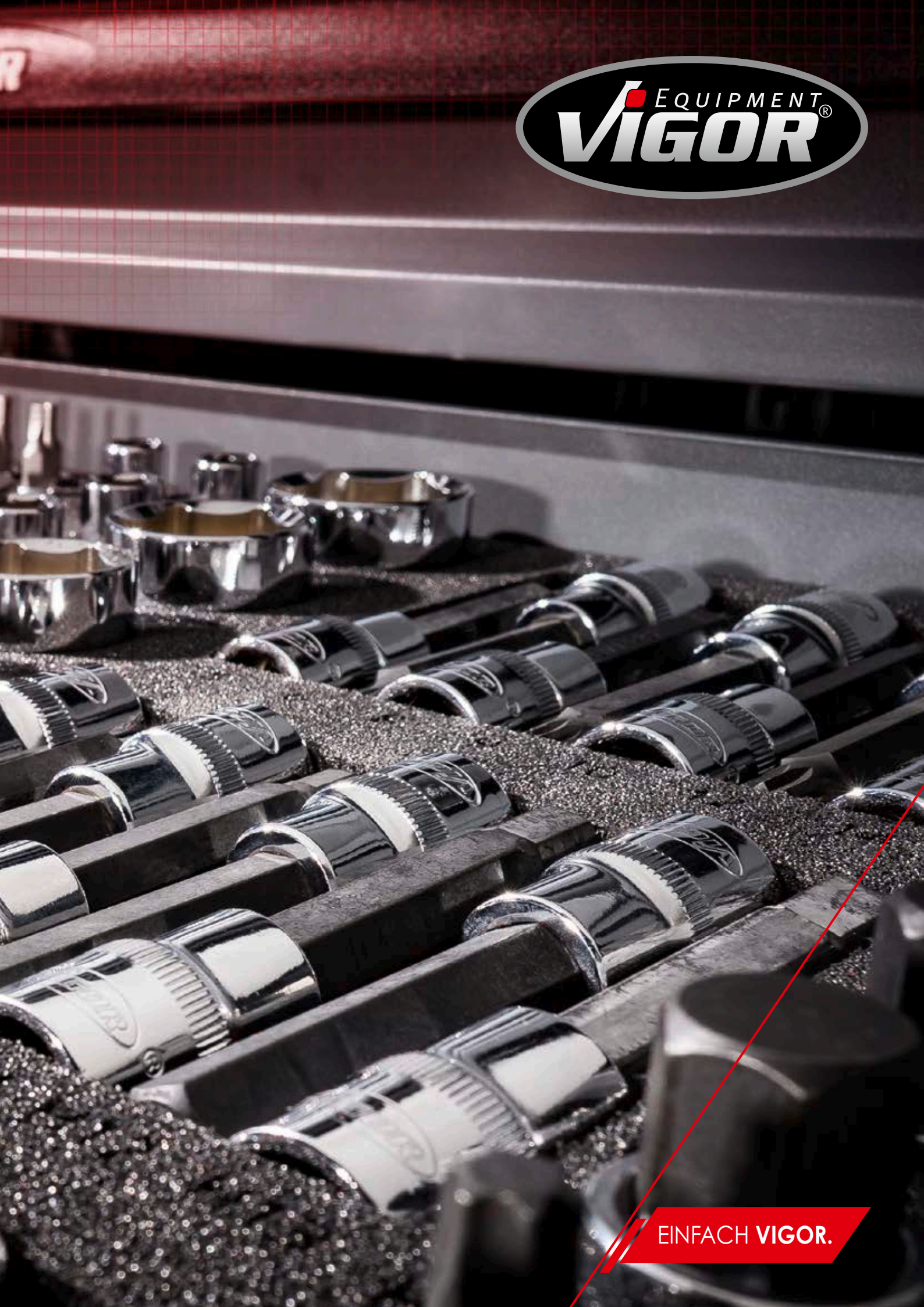

EINFACH VIGOR.

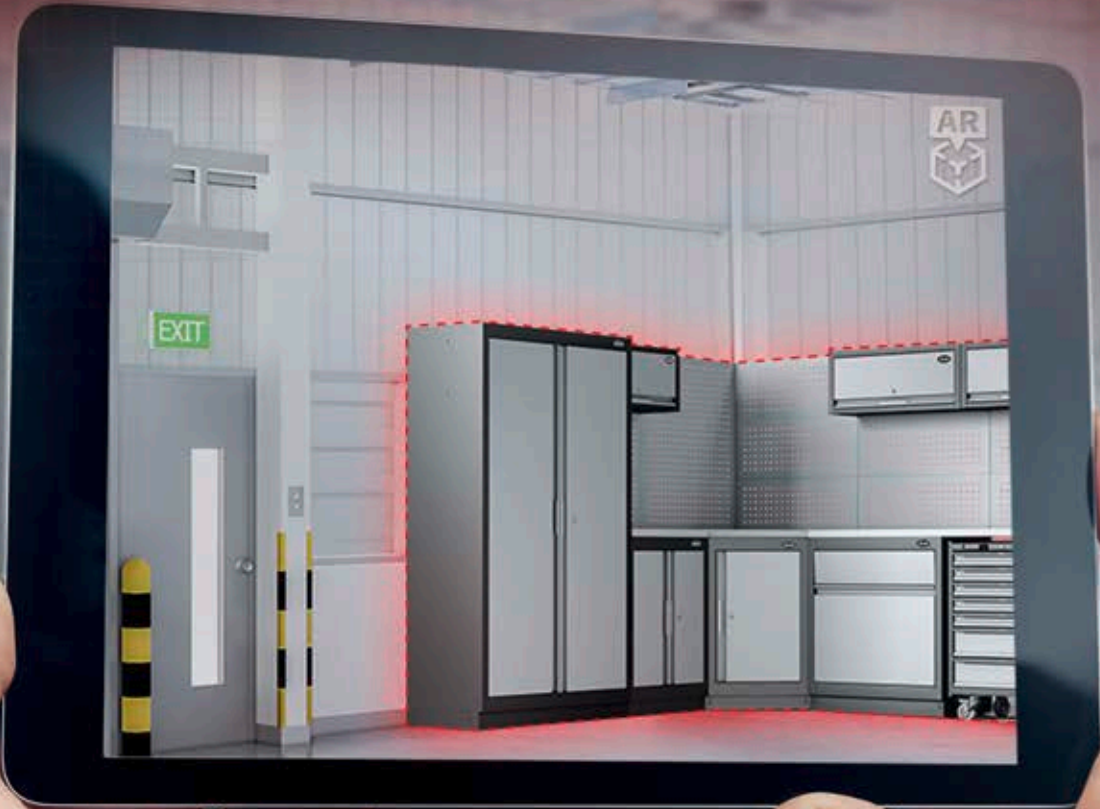

[www.vigor-equipment.com/konfigurator](http://www.vigor-equipment.com/konfigurator)

 **KONVIGORATOR**

**Jetzt mit neuen Funktionen!**



**TAZOLL** GMBH

BATTERIEN & WERKZEUGE

Copyright! 2024 by VIGOR GmbH

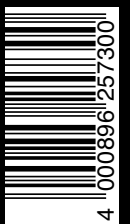

VIGOR GmbH · Am Langen Siepen 13-15 · D-42857 Remscheid · GERMANY [info@vigor-equipment.com](mailto:info@vigor-equipment.com) · [www.vigor-equipment.com](http://www.vigor-equipment.com)

Alle Artikel nur solange der Vorrat reicht! Abbildungen können aus Darstellungsgründen vom Original abweichen und sind daher unverbindlich. Technische Änderungen vorbehalten. Keine Haftung für Druckfehler.